



Aerodrome Manual

Brisbane Airport Corporation
Version 9.2 November 2018

Contents

CONTENTS	1
FOREWORD	10
AMENDMENT CHECKLIST	11
TELEPHONE CONTACT LIST	12
PART 1	13
SECTION 1 - AERODROME SITE INFORMATION	13
1.1 AERODROME SITE INFORMATION	14
1.1.1 Brisbane Airport Corporation, Existing Airport Layout	14
1.1.2 Taxiway Names and Widths	14
1.1.3 Brisbane Airport Corporation Facilities Map	14
1.1.4 Brisbane Airport CBD and Residential Areas	14
Attachment A - Existing Airport Layout	15
Attachment B – Taxiway Name and Widths	16
Attachment C – Brisbane Airport Facilities Map	17
Attachment D – Brisbane Airport CBD and Residential Areas	17
1.2 AERODROME CERTIFICATE CONDITIONS	19
PART 2	20
SECTION 1 - AERODROME ADMINISTRATION	20
1.1 AERODROME ADMINISTRATION	21
1.1.5 Safety Management System	21
1.1.6 The Safety Management Process	21
1.1.7 A Risk Based Approach	22
1.1.8 Standard Operating Procedures (SOPs)	24
1.1.9 Notice to Officers (NTOs)	24
1.1.10 Organisational Structure	24
1.1.11 Roles and Responsibilities	25
1.1.12 Manual Amendments	26
1.1.13 CASA Directions	26
1.1.14 Current exemptions	26
1.1.15 Current Agreements	27
1.1.16 Current Variations	27
SECTION 2 - AERODROME EMERGENCY PLAN	32

2.2	AERODROME EMERGENCY PLAN (AEP)	33
	SECTION 3 - AERODROME LIGHTING	34
2.3	AERODROME LIGHTING	35
2.3.1	Aerodrome Lighting Inspections	35
2.3.2	Serviceability and performance inspections:	35
2.3.3	Technical inspections:	35
2.3.4	Recording Inspection Results	36
2.3.5	Lighting Backup	36
2.3.6	Routine Maintenance	36
2.3.7	Routine Maintenance	37
2.3.8	Aerodrome Lighting Facilities	37
2.3.9	Obstacle Lighting	37
2.3.10	Apron earthing points	37
2.3.11	Planning, installing and maintaining new and existing equipment	38
2.3.12	Roles and Responsibilities	38
	SECTION 4 - AERODROME REPORTING	40
2.4	AERODROME REPORTING	41
2.4.1	Reporting Requirements	41
2.4.2	Reporting Temporary Changes	41
	Attachment E - NOTAM Request Form	43
2.4.3.1	Reporting temporary changes:	44
2.4.3.2	Reporting permanent changes:	44
2.4.3.3	Reporting incidents and accidents	44
2.4.3.4	The designated contacts for Brisbane Airport are:	44
2.4.4	Reporting changes published in AIP to AIS and CASA	45
2.4.5	Record Keeping	45
2.4.6	Reporting Incidents and Accidents	45
2.4.7	Reporting obstacle penetrations of PANS-OPS surfaces	45
2.4.8	NOTAM	46
	SECTION 5 - UNAUTHORISED ENTRY TO AERODROME	47
2.5	UNAUTHORISED ENTRY TO AERODROME	48
2.5.1	Arrangements for controlling airside access	48
2.5.1.1	Airside Security	48
2.5.1.2	Airside Vehicle Access and Airside Driving	48
2.5.1.3	Animals Airside	48
2.5.1.4	Airside Access	48
2.5.1.5	Airside Boundary	49
2.5.1.6	Airside Security Roles and Responsibilities	49
	SECTION 6 - AERODROME SERVICEABILITY INSPECTIONS	51
2.6	AERODROME SERVICEABILITY INSPECTIONS	52
2.6.1	Aerodrome Serviceability inspections during and after working	52
2.6.2	Specific Serviceability Inspections	53
2.6.3	Routine serviceability inspections	53

2.6.4	Lighting serviceability inspections	54
2.6.5	Lighting serviceability inspections	54
2.6.6	Communicating with Air Traffic Control	55
2.6.7	Serviceability Inspection Records	55
2.6.7.1	OPS 20 - Movement area – daily duties:	55
2.6.7.2	OPS 21 - Movement area – daily duties:	56
2.6.7.3	OPS 22 - Movement area – daily duties:	56
2.6.7.4	OPS 23 - Movement area – daily duties:	56
2.6.7.5	OPS 24 – Team Leader	57
2.6.7.6	OPS 25 - Movement area – daily duties:	57
2.6.8	Reporting Inspection Results	57
2.6.9	Roles and Responsibilities	58
SECTION 7 - AERODROME TECHNICAL INSPECTIONS		59
2.7	AERODROME TECHNICAL INSPECTIONS	60
2.7.1	Roles and Responsibilities	60
2.7.2	The arrangements for technically qualified people to carry out the technical inspections	61
2.7.3	Technical Inspections records	61
SECTION 8 - AERODROME WORKS SAFETY		62
2.8	AERODROME WORKS SAFETY	63
2.8.1	Method of Working Plan	64
2.8.2	Works planning	64
2.8.3	Stakeholder Consultation	64
2.8.4	Format	64
2.8.5	Amendments	64
2.8.6	Notification	64
2.8.7	Permit to commence work	65
2.8.8	Unscheduled works	65
2.8.9	MOWP Distribution	65
2.8.10	MOWP notification - aircraft operators and other aerodrome	65
2.8.11	MOWP notification – Air Traffic Control	65
2.8.12	Time Limited Works	65
2.8.13	Works on Runway Strips	66
2.8.14	Aerodrome Reporting Officer and WSO	66
2.8.15	Roles and Responsibilities	66
SECTION 9 - AIRCRAFT PARKING CONTROL		68
2.9	AIRCRAFT PARKING CONTROL	69
2.9.1	Apron management	69
2.9.2	Allocating Parking Positions	69
2.9.3	Designated Parking Areas	69
2.9.4	Common User - Bay Allocation Guidelines	70
2.9.5	Apron Servicing Licence Agreement	70
2.9.6	Other Parking Arrangements	70
2.9.7	Freight Operations	70
2.9.8	Aircraft Clearances	70
2.9.9	DTB Visual Docking Guidance	70
2.9.10	Domestic Terminal Apron Parking Positions	71

2.9.11	Position Identification Unit (Bay Marker)	72
2.9.12	Nose-in Guidance System (NIG)	72
2.9.13	Stopping Indicator	72
2.9.14	ITB Apron Visual Docking Guidance	72
2.9.15	International Terminal Apron Parking Positions	73
2.8.15.1	International apron aerobridge type and parking restrictions	73
2.9.16	Marshalling Service	73
2.9.17	Changes and additions to apron stand layout	74
2.9.18	Logistics Apron Parking Positions	74
2.9.19	General Aviation Apron Parking Positions	75
 SECTION 10 - AIRSIDE VEHICLE CONTROL		 76
2.10	AIRSIDE VEHICLE CONTROL	77
2.10.1	Authorities	77
2.10.2	Traffic Rules	77
2.10.3	BAC Requirements	777
Attachment F – Letter of Agreement (LOA) 406 BAC and Airservices		78
2.10.4	Driver Requirements	799
2.10.5	Vehicle Requirements	799
2.10.6	A-SMGCS	79
Attachment G – CASA Letter A-SMGCS		80
2.10.7	Speed Limits	82
2.10.8	Enforcement	82
2.10.9	Airside Safety Committee	82
2.10.9.1	Airside Safety Committee members	82
2.10.9.2	Airside Safety Committee procedures	82
2.10.10	Records	82
2.10.11	ADA Testing	82
2.10.12	Escorts	83
2.10.13	Roles and Responsibilities	83
 SECTION 11 - WILDLIFE HAZARD MANAGEMENT		 84
2.11	WILDLIFE HAZARD MANAGEMENT	85
2.11.1	Wildlife Hazard	85
2.11.2	Data collection	85
2.11.3	Bird strikes	85
Attachment H – Bird Strike Report		86
2.11.4	Significant Strike Reporting Procedure	87
Attachment I – Significant Strike Reporting Checklist		88
2.11.5	Animal incursions and strikes	89
2.11.6	Hazard Assessment	89
2.11.7	Bird Control	89
2.11.8	Animal Control	89
2.11.9	Licences and Permits	89
2.11.10	Habitat and Land Management	90
2.11.11	Roles and Responsibilities	90
 SECTION 12 - OBSTACLE CONTROL		 91

2.12	OBSTACLE CONTROL	92
2.12.1	OLS and Type A Surveys	92
	Attachment J – Type A Chart RWY 01R/19L	93
	Attachment I – Type A Chart RWY 14/32	94
2.12.2	Daily monitoring	95
2.12.3	Administration	96
2.12.4	Short term Controlled Activities	96
2.12.5	Permanent or Long Term Controlled Activities	97
2.12.6	PANS-OPS Considerations	97
2.12.7	OLS Considerations	97
2.12.8	Non-Structural Controlled Activities	98
2.12.9	Roles and Responsibilities	98
	Attachment L – Application by the Proponent - Crane Application	100
	Attachment M – Obstacle Limitation Surface (OLS)	101
	Attachment N – PANS OPS	102
	Attachment O – Operating Heights for Mobile Cranes	103
	Attachment P – Maximum Lighting Intensities	104
	Attachment Q – Restricted Light Zones	105
SUB SECTION 2.12.10		106
CONTROLLED ACTIVITIES APPLICATION		106
2.12.10	Sub Section – Controlled Activities Applications	107
2.12.10.1	Controlled activities	107
2.12.10.2	How to use these guidelines	107
2.12.10.3	Long term PANS-OPS intrusions	107
2.12.10.4	Long term OLS intrusions	107
2.12.10.5	BAC Approval of Short Term Controlled Activities	108
2.12.10.6	BAC Approval of Very Short Term Controlled Activities	108
2.12.10.7	BAC Referred or Refused Short Term Controlled Activities	109
SUB SECTION 2.12.11		110
DEVELOPMENT ASSESSMENT – CRANE OPERATION APPLICATION		110
2.12.11	Sub Section – Crane Applications Overview	111
2.12.11.1	Definitions	111
2.12.11.2	Timing of Submissions and Response	111
2.12.11.3	Penalties	111
2.12.11.4	Background	111
2.12.11.5	What is the law?	111
2.12.11.6	What is Protected Airspace?	112
2.12.11.7	What is a Controlled Activity?	112
2.12.11.8	How do you know you need an approval?	112
2.12.11.9	How do you apply- Controlled Activity?	112
2.12.11.10	Assessment of Applications	113
2.12.11.11	Approval Process	113
2.12.11.12	The need for approval to operate cranes in protected airspace	113
2.12.11.13	How do you apply – Crane operations?	114
2.12.11.14	The approval	114
2.12.11.15	Further Information	114
SUB SECTION 2.12.12		115

DEVELOPMENT ASSESSMENT - PERMANENT STRUCTURE	115
2.12.12 Sub Section – Permanent Structure Overview	116
2.12.12.1 Definitions	116
2.12.12.2 Timing of Submissions and Response	116
2.12.12.3 Penalties	116
2.12.12.4 Lighting in the vicinity of aerodromes	116
SECTION 13 – DISABLED AIRCRAFT REMOVAL	119
2.13 DISABLED AIRCRAFT REMOVAL	120
2.13.1 Aerodrome Operator	120
2.13.2 Recovery Coordination	120
2.13.3 Arrangements for Notifying Certificate of Registration (COR)	121
2.13.4 Certificate of Registration Responsibilities	121
2.13.5 Other Agencies	121
2.13.6 Arrangements for liaising with ATC & Australian Transport Safety Bureau	121
2.13.7 Arrangements for Aircraft Removal Equipment	122
2.13.8 Operations Response Checklist	122
2.13.9 Sources of Aircraft Recovery Equipment	123
2.13.10 Roles and Responsibilities	123
SECTION 14 - HANDLING OF HAZARDOUS MATERIALS	125
2.14 HANDLING OF HAZARDOUS MATERIALS	126
2.14.1 Contacts for Receiving and Handling Hazardous Materials	126
2.14.2 General arrangements	126
2.14.3 Fire protection	127
2.14.4 Petrochemicals	127
2.14.5 Corrosive and radioactive materials	127
2.14.6 Explosives	128
2.14.7 Brisbane Airport Environment Strategy	128
2.14.8 Hazardous materials incidents	128
2.14.9 Requirements for Handling Explosives	129
2.14.10 Hazard Division	130
2.14.11 Contacts for handling hazardous materials	131
SECTION 15 - PROTECTION OF RADAR AND NAVIGATIONAL AIDS	132
2.15 PROTECTION OF RADAR AND NAVAIDS	133
2.15.1 Arrangements for the control of Nav aids	133
2.15.2 Need to Protect Nav aids	133
2.15.3 Access restriction	133
2.15.4 Nav aids Maintenance	133
2.15.5 Arrangements for New Works	133
2.15.6 Arrangements of Warning Signs	133
2.15.7 Arrangements for Ground Maintenance	134
SECTION 16 - LOW VISIBILITY OPERATIONS	135
2.16 LOW VISIBILITY PROCEDURES	136
2.16.1 Runway Visual Range (RVR)	136



2.16.2	Runway Visibility (RV)	136
2.16.3	Low Visibility Procedures (LVP)	136
2.16.4	RWY 01R/19L ILS Protection	136
2.16.5	Departures	137
2.16.6	Arrivals	137
2.16.7	Runway Visibility (RV) assessments	137
	Attachment R - List of Certified Runway Visibility Assessors	138
	Attachment S - Low Visibility Procedures – Alerting Checklist	139
2.16.8	General Arrangements	140
2.16.9	Airside security	140
2.16.10	Logbooks	140
2.16.11	Low Visibility – Decreasing Visibility Procedure	141
2.16.12	Low Visibility – Increasing Visibility Procedure	142
2.16.13	Roles and Responsibilities	143
	Attachment T - Table of Observed Distances	144
SECTION 17 – LOGBOOKS		145
2.17	LOGBOOKS	146
2.17.1	Logbooks and other operational documents	146
2.17.2	Daily Duty Log	146
2.17.3	Pavement defects reporting	147
2.17.4	Airfield lighting	147
2.17.5	Correspondence with government agencies	148
2.17.6	Reports following technical inspections	148
2.17.7	Prescribed airspace	148
2.17.8	Roles and Responsibilities.	148
SECTION 18 – PAVEMENT CONCESSIONS		149
2.18	PAVEMENT CONCESSIONS	150
2.18.1	Purpose of pavement concessions	150
2.18.2	Arrangements for granting pavement concession requests	150
2.18.3	Roles and Responsibilities	150
	Attachment U - Pavement Designations and Strengths	151
SECTION 19 – LIVESTOCK TRANSFERS		152
2.19	LIVESTOCK TRANSFERS	153
2.19.1	The arrangements for organising a livestock transfer	153
2.19.2	Standard procedures	154
2.19.3	Non-standard procedures	154
2.19.4	Roles and Responsibilities	154
SECTION 20 – ENGINE GROUND RUNNING		1555
2.20	ENGINE GROUND RUNNING	1566
2.20.1	Legal basis	1566
2.20.2	Locations, time and power setting limitations	1566
2.20.3	Non-complying engine ground running	1577
2.20.4	Reporting	1577



2.20.5	Engine Ground Run Checklist:	1577
2.20.6	Roles and Responsibilities	1588
	Attachment V - Engine Ground Running Limitations	160
	Attachment W - Mike Three Engine Ground Run Position	161
SECTION 21 – COMPASS SWING		162
2.21	COMPASS SWING	163
	Attachment X – Compass Swing Site Surveys Letter	164
	Attachment Y – Compass Swing Site Surveys Data	166
	Attachment Z – Compass Swing Site Surveys Line Marking	167
PART 3		168
PARTICULARS OF AERODROME TO BE PUBLISHED IN AIP		167
SECTION 1 – AERODROME GENERAL INFORMATION		1678
3.1	GENERAL INFORMATION	168
3.1.1	Aerodrome Information	1689
3.1.2	Air Traffic Flow Management Procedures	169
3.1.2.1	Runway Demand Management Scheme (RDMS)	169
3.1.3	Permanent NOTAMs	169
3.1.5	Rescue and Fire Fighting Services	169
3.1.6	Handling Services and Facilities	170
3.1.7	Aerodrome Obstacles	170
3.1.8	Meteorological Information Provided	1711
SECTION 2 – INFORMATION FOR RUNWAYS		172
3.2	INFORMATION FOR RUNWAYS	173
3.2.1	Physical Characteristics	173
3.2.2	Declared Distances for Runways - Brisbane	1734
3.2.3	Taxiway Intersection Declared Distances	174
SECTION 3 – INFORMATION VISUAL AID SYSTEMS		175
3.3	INFORMATION ABOUT VISUAL AID SYSTEMS	176
3.3.1	Aerodrome and Approach Lighting	1767
3.3.2	Other Lighting	1777
SECTION 4 – LOCAL INFORMATION		1788
3.4	LOCAL INFORMATION	179
3.4.1	Local Traffic Regulations	179
3.4.2	Training Flights	181
3.4.3	Noise Abatement Procedures	181
3.4.4	Additional Information	181



3.4.5	Charts Related to the Aerodrome	182
	GLOSSARY	184
	ABBREVIATIONS	209

Foreword



Brisbane Airport Corporation Pty Ltd (BAC) acquired the long term lease for Brisbane Airport from the Federal Government on 2 July 1997.

BAC's vision for Brisbane Airport is to bring prosperity and opportunity to the people of Queensland by providing an airport that connects the people of Queensland to the world, and enables travellers from around the world easy access to our State. Critical to this vision is the continued safe and efficient operational environment, and the minimisation of the impact on the environment and the community, maintaining a careful balance between impact and growth.

This Manual has been prepared primarily to satisfy BAC's obligations under *Civil Aviation Safety Regulations* Part 139 and in that context should be regarded as the ***Aerodrome Manual*** for Brisbane Airport.

It also contains details of essential operating procedures that may not be entirely safety related, but nevertheless are required to satisfy other legal requirements and common law obligations. The purpose of this Manual is twofold - to provide BAC staff with a comprehensive reference for use in the day to day operations of the airport, and to provide airport users with information about the guidelines and procedures that are applied in operating the airport. For this reason, the document is more appropriately entitled the ***Aerodrome Manual*** for Brisbane Airport.

The Manual has been structured to incorporate portions of other documents such as the ***Airport Emergency Plan***, the ***Airside Drivers Handbook***, the ***Transport Security Program***, the ***Safety Management System***, ***Wildlife Hazard Management Plan*** and the ***Airport Environment Strategy***. Each of these will continue to be amended and published separately to meet other legislative requirements but should be read in conjunction with this ***Aerodrome Manual***. The Manual should also be used in conjunction with Civil Aviation Safety Authority and Airservices Australia publications such as ***Manual of Standards Part 139 - Aerodromes*** and ***Aeronautical Information Publication***.

The Civil Aviation Safety Authority requires BAC to operate and maintain Brisbane Airport in accordance with the procedures set out in the ***Aerodrome Manual***. In producing this Manual our objective has been to ensure that the documented procedures are an accurate reflection of both current and best practices. It will be amended as and when necessary to reflect changing standards or operational practices.



Gert-Jan de Graaff
Chief Executive Officer

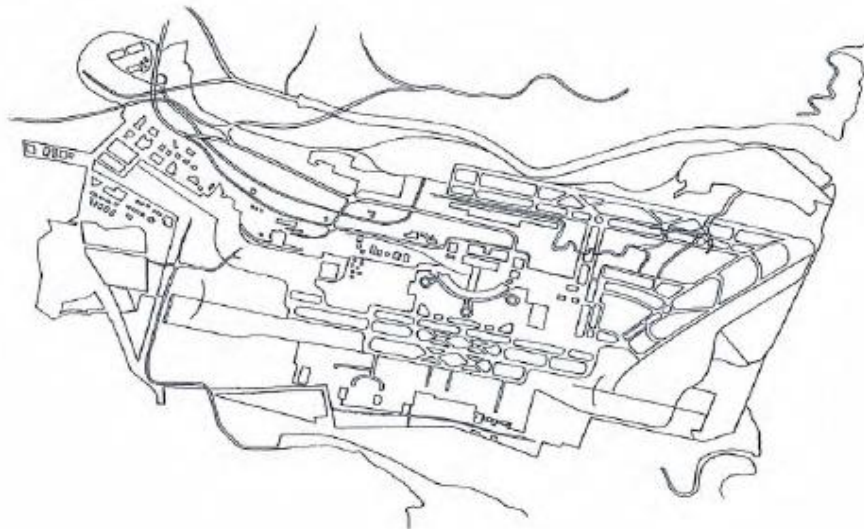

Amendment Checklist

Version	Date	Section/Page	Authorised By	Comment
9.2	05.11.2018	Section 2.4 Page 43 Attachment E	Peter Dunlop	Revised NOTAM Request Form
9.2	05.11.2018	Section 2.9.10 Page 71 Figure 8	Peter Dunlop	Domestic Apron Parking
9.2	05.11.2018	Section 2.9.15 Page 73 Figure 9	Peter Dunlop	International Apron Parking
9.2	05.11.2018	Multiple pages	Peter Dunlop	Amended to reflect RWYs 01R/19L
9.2	05.11.2018	Section 2.9.18 Page 74	Peter Dunlop	Logistics Apron Parking
9.2	05.11.2018	Section 2.9.19 Page 75	Peter Dunlop	General Aviation Parking
9.2	05.11/2018	Section 2.12 Pages 101 & 102	Peter Dunlop	Amended attachments to reflect 01R 19L
9.2	05.11.2018	Section 2.18, Page 150 Attachment U	Peter Dunlop	Pavement Designations and Strengths

Aerodrome Manual Distribution

This Aerodrome Manual is distributed electronically via digital media to ensure the latest version is available to all users for reference.

BAC maintains a digital distribution list. BAC and notifies all those on the distribution list when an amendment is issued. The amendments are available digitally on-line and through the [BAC web site](#). Activation of the amendment is recorded electronically.

Hard copies are not produced by BAC for distribution, but may be printed for internal office use. Any hard copies printed by recipients of the electronic distribution are not controlled. Care must be taken to ensure that paper copies are disposed of or fully amended upon expiry.

Telephone Contact list

BRISBANE AIRPORT CORPORATION - All numbers are local the Brisbane STD prefix is 07.

DEPARTMENT	POSITION	NAME	PHONE
Head Office	Reception	Various	3406 3000
CEO	Chief Executive Officer	Gert-Jan de Graaff	3406 3033
Human Resources	Acting Head of HR	Jane Dionysius	3406 3091
Strategic Planning & Development	General Manager - SPD	Floor Felton	3406 3061
	Head of Airport Development	Mark Wiley	3406 3047
Maintenance	Facilities Call Centre (After Hrs Only)	Various	3406 5753
Operations	General Manager Operations	Stephen Goodwin	3406 3127
	Airside Operations Manager	Peter Dunlop	3406 5774
	Airside Standards Manager	Chris Young	3406 3169
	Airside Safety Systems & Audit Manager	David Selby	3406 3388
	Environment & Sustainability Manager	Wendy Weir	3406 3268
	Airside Coordination Manager	Aaron Pond	3406 5765
	Airside Operations Team Leaders/Officers	Various	3406 3072
	Airside Wildlife & Planning Coordinator	Jackson Ring	3406 3283
	Customer Experience & Facilities Manager	Luke Harvey	3406 5765
	Terminals Operations Manager	Jarrad Ripp	3406 3210
	Domestic Terminal Transition Manager	Allan Miller	34063374
	Duty Terminal Manager (DTM) & Control Coordinators	Various	3406 3171
	Security & Emergency Planning Manager	Gary Bowden	3406 3013
	Security Operations Manager	Gary Chadwick	3406 3266
	Assets	General Manager Assets	Krishan Tangri
CAD & Spatial Services Manager		Liz Hagen	3406 3015
Airport Facilities Manager		Ken Hughes	3406 3287
Civil & Airport Lighting Asset Maintenance Manager		Anu Karunaratne	3068 6694
Airport Lighting Coordinator		Paul Butlin	3406 3083
Building Assets and Maintenance Manager		Kevin Blazely	3406 3095

Part 1

Aerodrome Information

Section 1 - Aerodrome Site Information

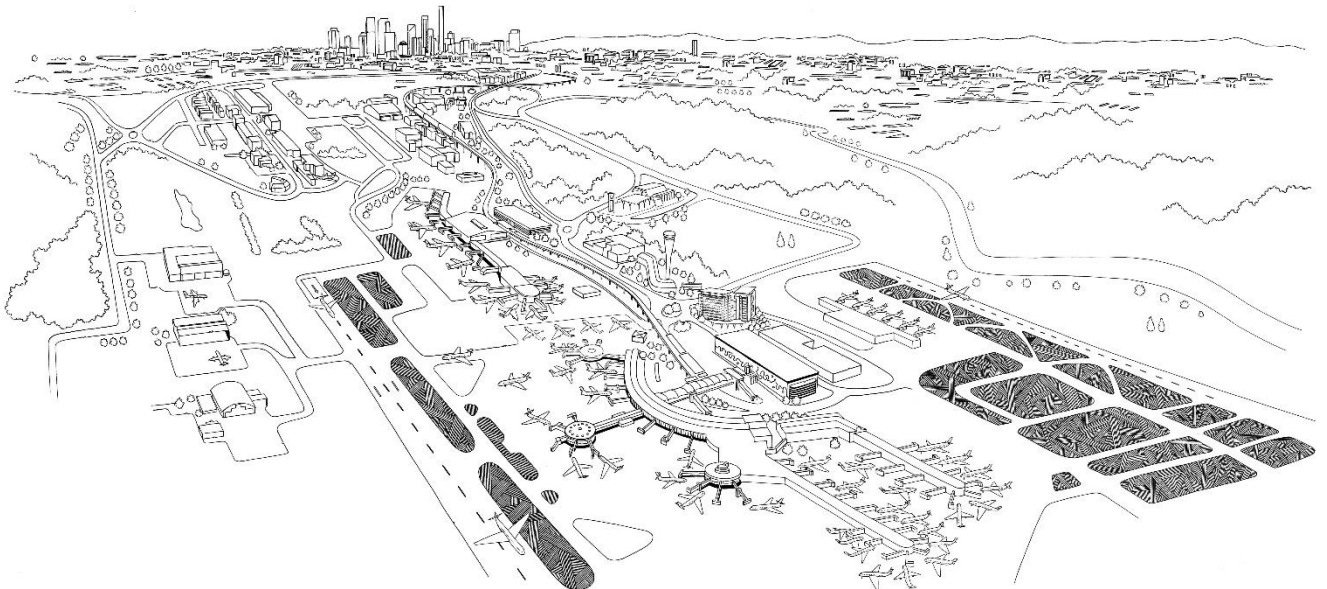

1.1 Aerodrome site information

To meet the requirements for subparagraph 139.095 (a) (i), the particulars are as follows:

- (a) A plan of the aerodrome showing the main aerodrome facilities, including the wind direction indicators, for the operation of the aerodrome;
Taxiway widths should also be shown on the drawing.

1.1.1 Brisbane Airport Corporation, Existing Airport Layout

Attachment A

1.1.2 Taxiway Names and Widths

Attachment B

- (b) A plan of the aerodrome showing the aerodrome boundaries;

1.1.3 Brisbane Airport Corporation Facilities Map

Attachment C

- (c) A plan showing the distance of the aerodrome from the nearest city, town or other populous area, and the location of any aerodrome facilities and equipment outside the boundaries of the aerodrome;

1.1.4 Brisbane Airport CBD and Residential Areas

Attachment D

The declared Brisbane Airport site pursuant to regulation 1.03 of the Airports Regulations 1997 comprises the following parcels of land:

Parish	County	Title Reference	Lot No.	Plan
Toombul	Stanley	50146353	4	838457
Toombul	Stanley	50146354	5	838457
Toombul	Stanley	18740240	1	844114
Toombul	Stanley	18740241	2	844116
Toombul	Stanley	18174183	1161	11534
Toombul	Stanley	50146351	2	838457

References

Advisory Circular

AC 139-17(0) *Preparing Plans for Inclusion in Aerodrome*

Attachment A - Existing Airport Layout

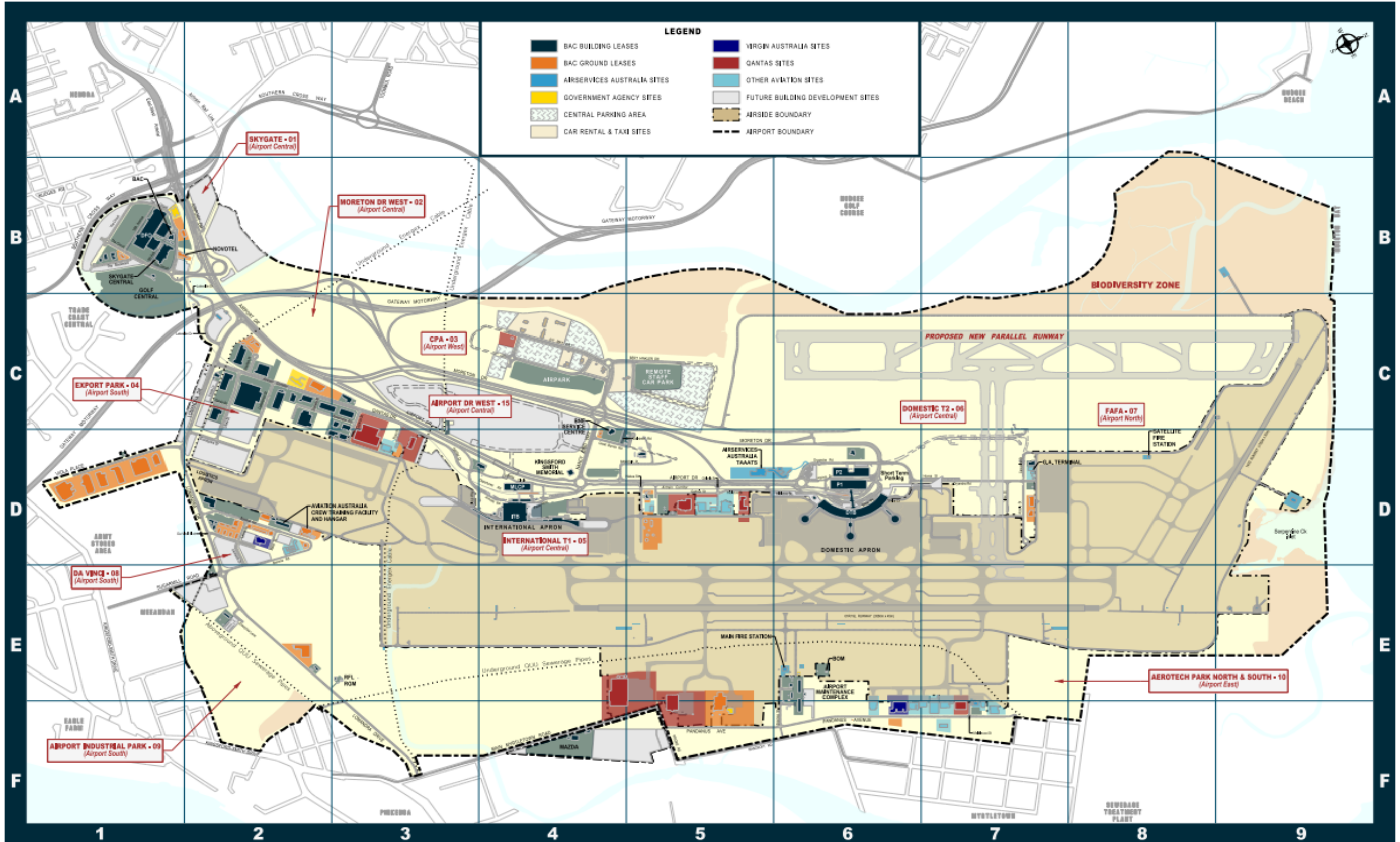

Attachment B – Taxiway Name and Widths

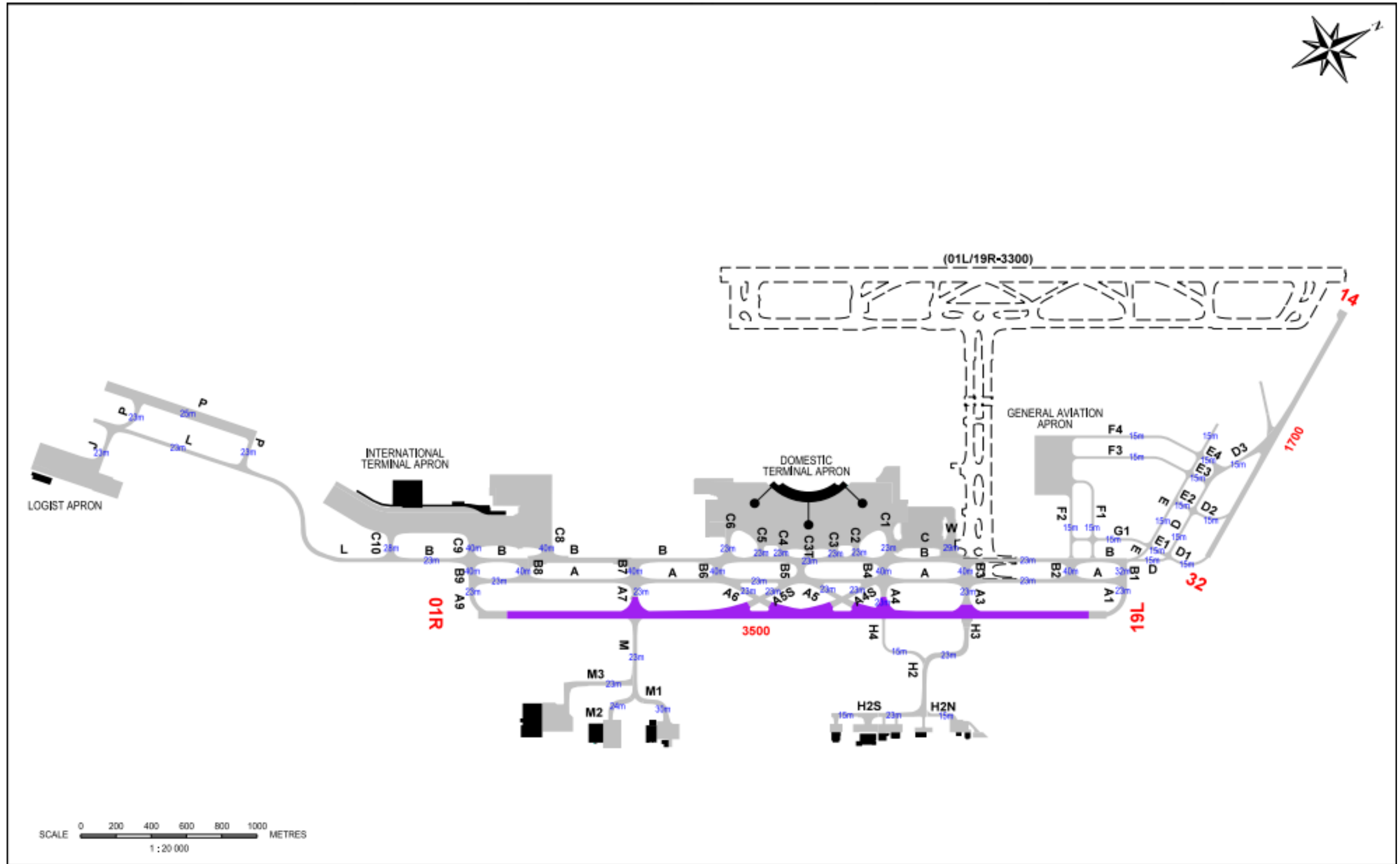

Attachment C – Brisbane Airport Facilities Map

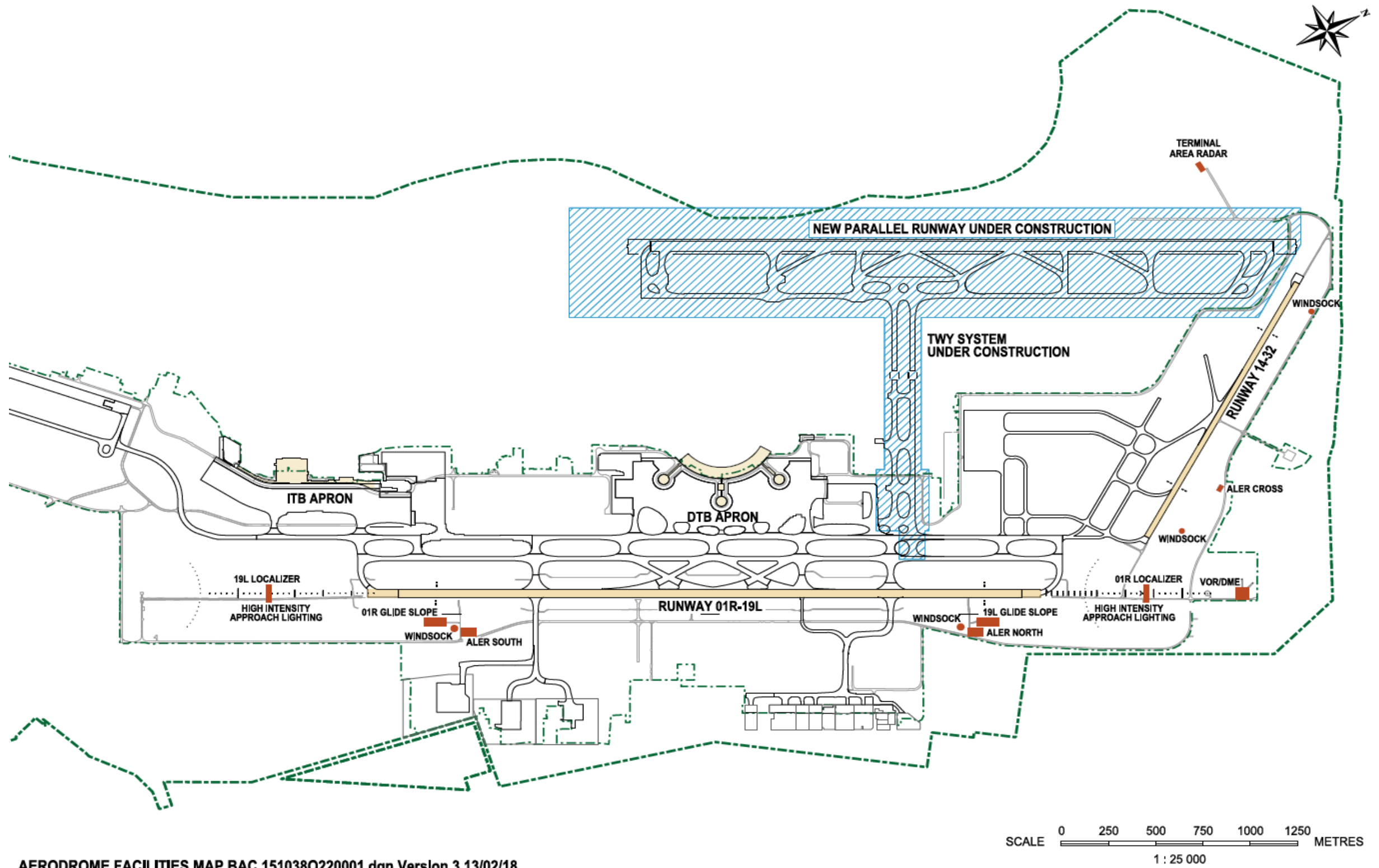

AERODROME FACILITIES MAP BAC 151038O220001.dgn Verslon 3 13/02/18

Attachment D – Brisbane Airport CBD and Residential Areas

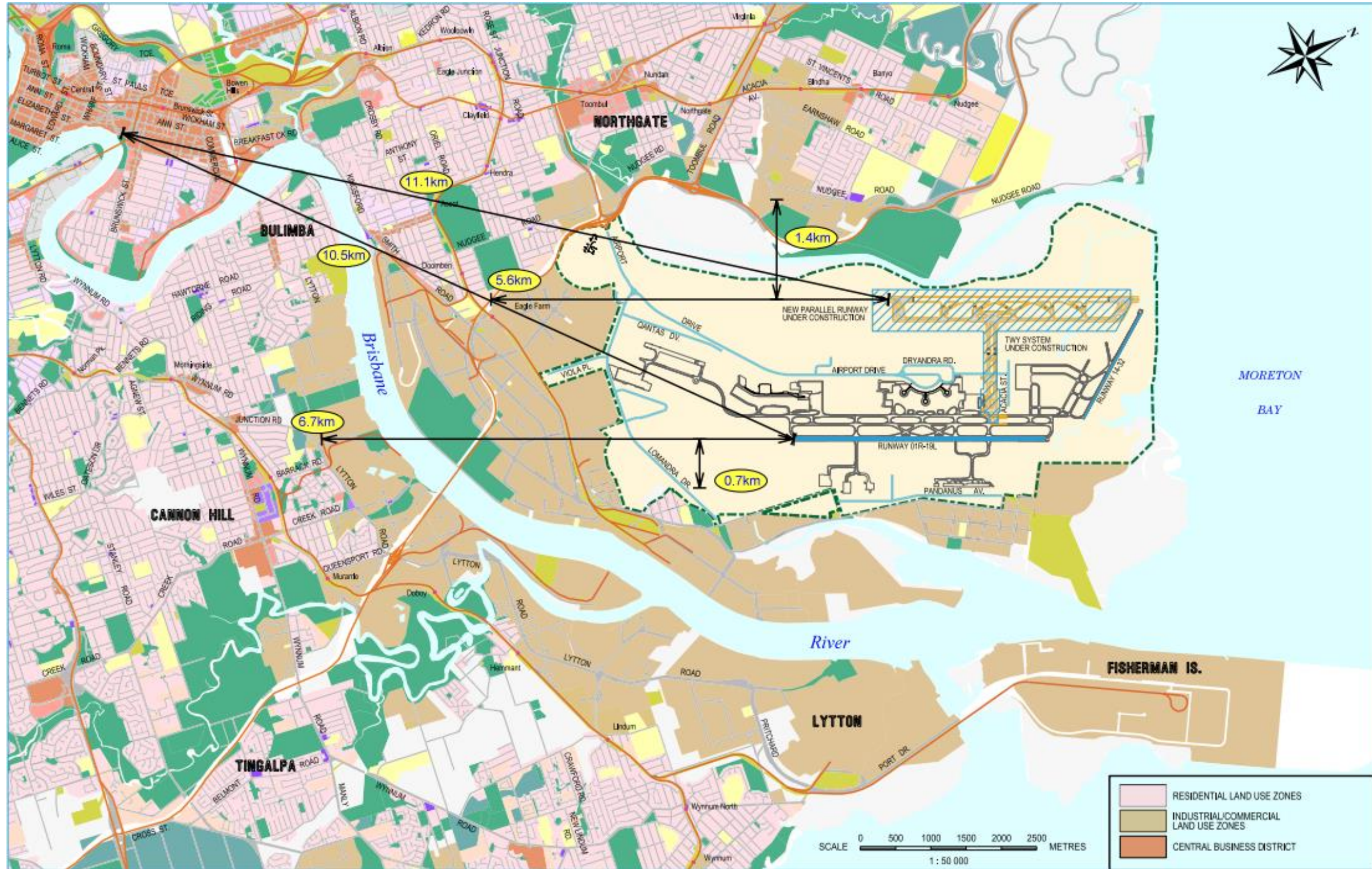

1.2 Aerodrome Certificate Conditions

To meet the requirements of CASR 139.095(a) (iv) this section deals with the particulars of any condition to which the operator's aerodrome certificate is subject.

The airport meets the certification requirements of CASR 139.B. There are no conditions attached to the certificate. A copy of the Aerodrome Certificate for Brisbane Airport is shown below. (Figure 1)

References

CASRs

Subpart 139.B *Certified Aerodromes*

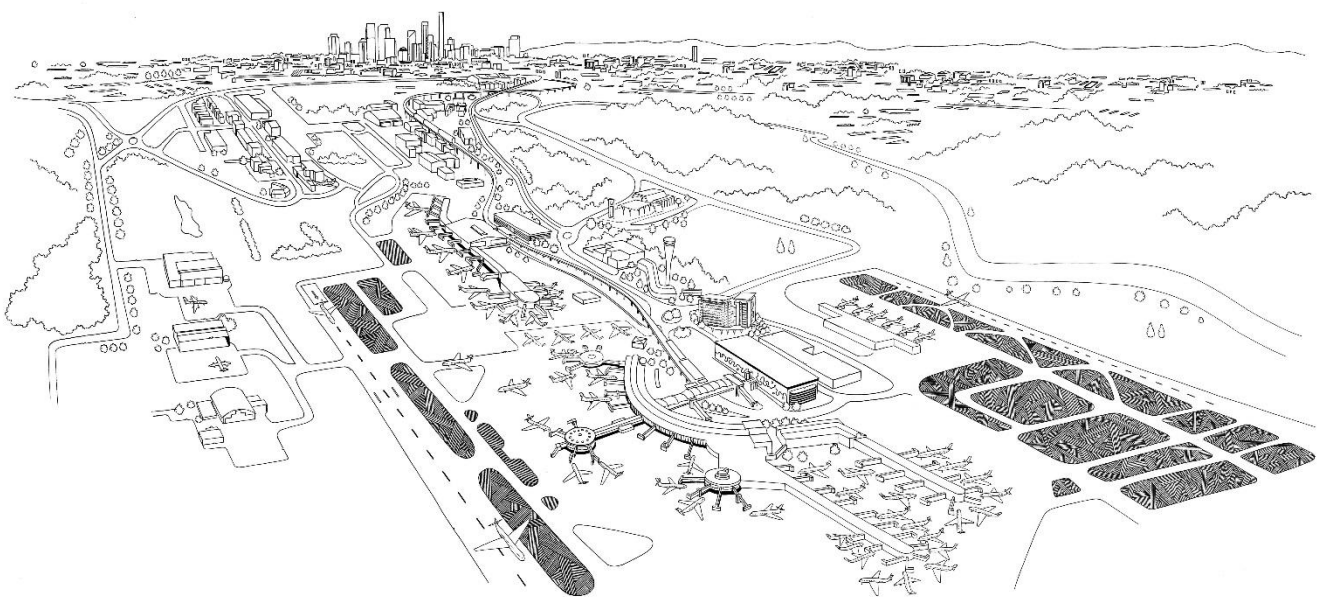

Figure 1 Aerodrome Certificate

Part 2

Aerodrome Administration and Operating Procedures

Section 1 - Aerodrome Administration



1.1 Aerodrome Administration

To meet the requirements of Appendix 1 to CASR subparagraph 139.095 (a) (ii) this section deals with the “Particulars of the aerodrome administration and operating procedures” For subparagraph 139.095 (a) (ii), the particulars are as follows:

Aerodrome administration.

- (i) particulars of the aerodrome administration including the following:
- (ii) the organisational structure;
- (iii) the management positions responsible for the operation and maintenance of the aerodrome;
- (iv) contact details of the person who is the aerodrome manual controller;
- (v) contact details for the main persons responsible for aerodrome operations and safety functions; owing:

1.1.5 Safety Management System

The Brisbane Airport Safety Management System Manual is published and distributed independently of the Aerodrome Manual. It has been prepared to ensure safety and standardisation in the conduct of BAC operations. In accordance with CASR 139.100(3) the SMS has been adopted as Annex 1 to this Manual.

The Safety Management Manual (SMM) documents BAC’s Aviation Safety Management System as it relates to matters of aviation safety, in order to meet the regulatory requirements, and as part of BAC’s Corporate desire to make the airside at Brisbane Airport as safe as possible.

1.1.6 The Safety Management Process

ICAO’s *Safety Management Manual* (Doc 9859) outlines a safety management process, which is represented as a ‘continuous loop’ process in the figure 2 below:

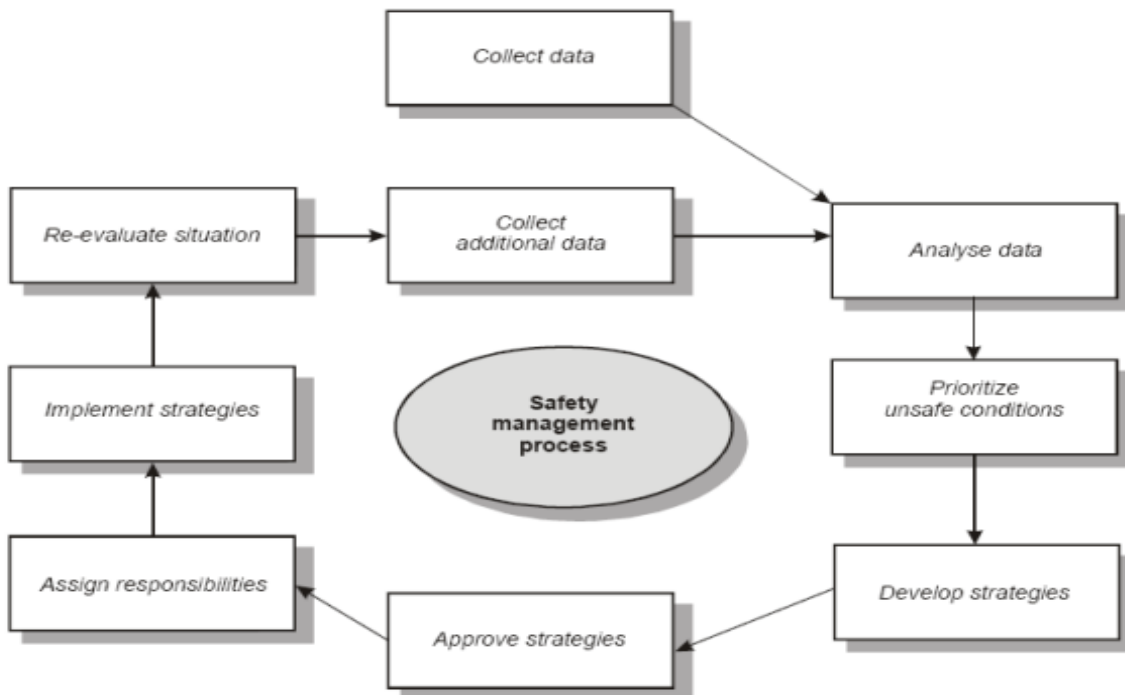

Figure 5-2. Safety management process

Figure 2 ICAO Safety Management Manual (Doc 9859), p 5-7

The Manual has been structured to incorporate portions of other documents such as the:

- (a) *Occupational Health & Safety Management System,*
- (b) *Airport Emergency Plan,*
- (c) *Airside Drivers Handbook,*
- (d) *Transport Security Program,*
- (e) *Aerodrome Manual,*
- (f) *Wildlife Hazard Management Plan*
- (g) *Environment Management Strategy.*

Each of these will continue to be amended and published separately to meet other legislative requirements but should be read in conjunction with this *Aviation Safety Management System*. The Manual should also be used in conjunction with Civil Aviation Safety Authority – *Manual of Standards Part 139 - Aerodromes*.

1.1.7 A Risk Based Approach

Risk management is part of the BAC culture and is undertaken at all corporate and business unit / project levels. The overall aim of risk management within BAC is to ensure that organisational capabilities and resources are employed in an efficient and effective manner to manage both opportunities and threats/hazards.

To this end, BAC has a system of Risk Management which is both a top down (Enterprise wide) and bottom up approach (Figure 3) including risk/hazards assessments from;

- departments,
- contracts,
- projects and
- significant changes to operations.

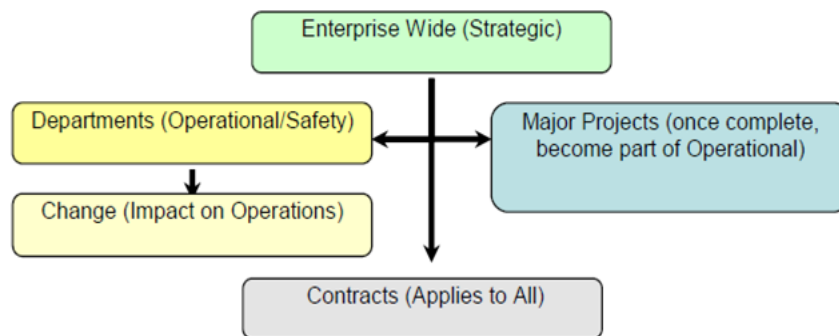

Figure 3 Risk Management

The objective of this Safety Management System (SMS) is to provide a formal mandatory process to assist BAC in:

- Developing and implementing procedures to ensure that all risks (including safety risks) are identified, assessed against accepted criteria and that appropriate measures are implemented;

- Defining and documenting a risk management system of responsibilities and processes required to integrate risk management into all facets of the business;
- Establishing a culture of risk awareness and management;
- Creating customised risk management tools such as this system and Tracker Airside which was developed to address Aviation Safety and also to meet the needs of specialised units of the business, whilst ensuring a consistency in language and a sustainable outcome for the business;
- Encouraging understanding by managers and their staff of the implications of risk exposures, opportunities and their risk management, in their day-to-day work and in strategic and operational/safety planning activities; and
- Linking risk management to corporate, safety, project and business process planning.

The procedures documented in this manual are initially developed to address generic hazards/risks in airport operation identified by CASA in accordance with Appendix 1 to CASR 139.095. These procedures have been refined over time and a number of additional procedures have been adopted to address hazards/risks specific to Brisbane Airport operations.

Tracker Airside is utilised by BAC Airside Operations to record, track and influence aerodrome compliance, safety, incident management, operational maintenance and overall aerodrome analytics.

In each case the procedure has evolved and/or has been developed through application of the SMS and measures have been identified as necessary to monitor and/or manage the associated hazards/risks. A number of these procedures require further risk assessments to be carried out when changes are proposed or detected in the physical condition or operational environment of Brisbane Airport.

The *Safe Planning and Conduct of Aerodrome Works* is an example where risk assessments have identified general safeguards, processes or procedures to be adopted, but where further risk assessment is anticipated when specific details of projects are known. This project or task specific risk assessment is used formulating the relevant *Method of Working Plan (MOWP)* and/or *Safe Work Method Statement* for time limited works.

Hazards might arise from unexpected changes in the physical condition of facilities or environmental hazards such as the presence of birds on or in the vicinity of the airport. Day-to-day operations require regular checks of facilities and monitoring of the operating environment. These routine tasks themselves need to be managed in a way that does not cause a hazard to aircraft operations.

Emergency situations need to be anticipated and planned for in a manner that optimises the response and through the SMS, exercises, briefs and debriefs, hazards can be identified and risks mitigated.

Following are some examples of activities whereby the SMS is routinely applied in the day-to-day operation of Brisbane Airport.

- Low Visibility Procedures
- Firearm Safety and Storage
- Wildlife Management (culling, dispersal, handling)
- Airside Spills (fuel, oil, sewage)
- Movement Area Closures
- Serviceability Inspections
- Escorts
- Works Safety Officers

1.1.8 Standard Operating Procedures (SOPs)

SOPS consist of a set of instructions having the force of a directive, and covering those features of operations that lend themselves to a definite or standardised procedure. Standard Operating Procedures can act as effective catalysts to drive performance-improvement and improve organisational results. The procedures in this manual will be reviewed annually or as required.

Individual SOPs have been developed for the relevant sections of the Aerodrome Manual Section 2, to be reviewed as required. All SOPs are available for access through Tracker Airside.

1.1.9 Notice to Officers (NTOs)

'Notice to Officers' is a communication tool to assist in the communication process across the Airside Operations Centre to ensure everyone receives the same message and acknowledges receipt of that message to ensure consistency of our operating procedures. All new NTOs issued will appear in Tracker Airside when logging on to a new shift and must be read and accepted before the Software Application allows the user any further access to the program.

This supporting document set should be read in conjunction with the current Aerodrome Manual and Standard Operating Procedures.

1.1.10 Organisational Structure

The organisation chart for Brisbane Airport Corporation Operations Group, including Airside Operations is detailed in Figure 4

ORGANISATION CHART

AS @ 29 OCTOBER 2018

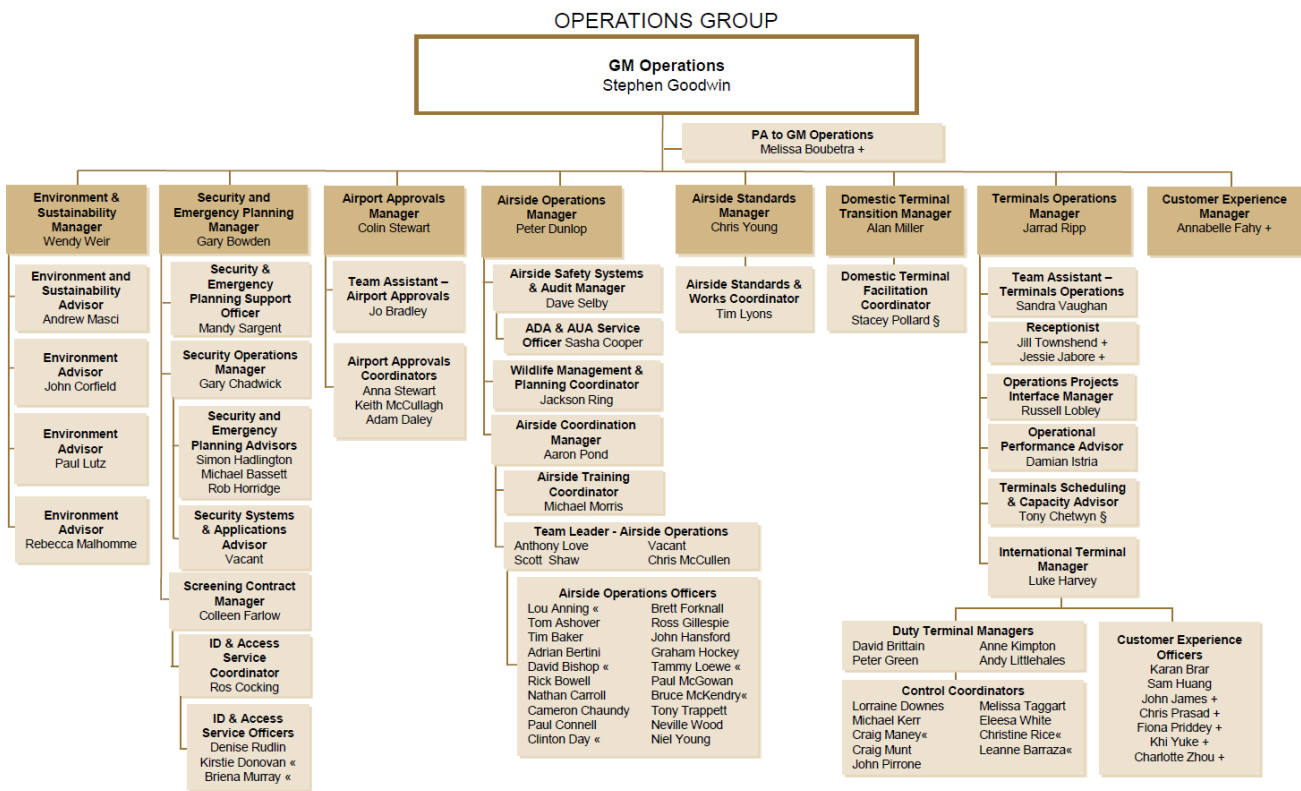

Figure 4 Operations Group

1.1.11 Roles and Responsibilities

Below is an outline of the management positions responsible for the operation and maintenance of the aerodrome:

- a. The CEO has overall responsibility for formulation of policy and procedures to ensure the airport is managed, operated and maintained safely to meet its legal obligations.
- b. The General Manager operations is responsible for ensuring that:
 - airport facilities and equipment are planned, constructed, installed and maintained in accordance with MOS requirements;
 - procedures are in place and documented to promote safety and meet CASA standards; and
 - resources are available to implement the procedures safely, efficiently and effectively.
 - The Airside Operations Manager is the Aerodrome Manual controller. The contact details can be found on the Telephone Contact List at the front of the Manual. The Airside Operations Manager maintains the electronic master copy of the Manual. The Airside Operations Manager is responsible for:
 - implementing the procedures;
 - carrying out or arranging technical inspections;
 - ensuring Airside Operations Staff and Works Safety Officers are trained in accordance with the requirements of the CASRs, MOS and applicable industry standards;
 - keeping training records;
 - ensuring appropriately qualified persons conduct technical inspections;
 - organising amendments to the Manual;
 - the day to day oversight of the safety aspects of all airside operations
- c. The Airside Standards Manager is responsible for providing high level technical expertise in ensuring BAC maintains compliance with Aerodrome Certificate and regulatory requirements through the management of day-to-day airside legislative and regulatory obligations.
 - ensuring compliance with aerodrome certificate conditions, exemptions and CASA standards;
- d. The Airside Safety Systems & Auditing Manager is responsible for managing the development, implementation and administration of the Aviation Safety Management System with a focus on delivering a Safety System that supports Brisbane Airport's ongoing compliance with applicable aviation safety and risk management legislation and regulations.
- e. The Airside Coordination Manager is responsible for coordinating day to day airside operations, staffing levels for each shift/works.
- f. The Security and Emergency Planning Manager is responsible for compliance of Aviation Transport Security Regulations and associated policy development, the preparation, maintenance and exercising of the airport emergency plan and development of BAC security policy in accordance with the transport security program and ASIC program.
- g. The Building Facilities Asset Manager is responsible for terminal maintenance, apron floodlighting and other apron facilities.
- h. Duty Terminal Manager/Control Coordinator is responsible for allocation of particular aircraft bays; time limitations applying to the use of aircraft stands; and removal of aircraft when a time limitation has been exceeded or in an emergency.

1.1.12 Manual Amendments

The Airside Operations Manager is the only person who can authorise amendments to the Manual. The need to amend the Manual may be triggered by:

- Changes to CASA standards/requirements;
- Changes in published airport information;
- Changes to documented procedures identified by airport staff, users and/or tenants.
- Changes to organisational structure and/or contact details

The Airside Operations Manager reviews the continued appropriateness of Manual procedures with the Airside Standards Manager, Safety Systems and Auditing Manager, Airside Coordination Manager and others as required at least annually or as necessary.

Amendments are marked with a black bold line to the right hand side of the text. (Maps & Charts may not be included due to formatting) In the case of a totally New Edition/rewrite there shall be no black lines marked to the right hand side of the text. Refer to the amendment checklist for confirmation.

The Amendment Checklist is also amended to reflect the changed pages, amended date and the new version number. Once complete, the Airside Operations Manager, or delegate notifies CASA of the amendment within 30 days

If circumstances require a temporary deviation from documented procedures to ensure the safety of aircraft, the Airside Operations Manager, or delegate notifies CASA within 30 days of the deviation being made.

1.1.13 CASA Directions

Under CASR 139.105(2), CASA may give written directions to the airport operator requiring the operator to amend the manual in accordance with the direction. CASA may also direct an amendment to procedures in the Manual in the interests of aircraft safety under CASR 139.145(2). If given such directions, the Airside Operations Manager, or delegate organises an appropriate amendment.

In addition to those managers responsible for the operation and maintenance of the airport, the Aerodrome Reporting Officers, under the direction of the Airside Operations Manager and supported by BAC technical staff are responsible for the safe day to day operation of the airport. The contact details for those responsible for aerodrome operations, maintenance and safety functions can be found on the Telephone Contact List.

1.1.14 Current exemptions

To meet the requirements of CASR 139.095(c) this section deals with the particulars of any exemption given to Brisbane Airport by CASA under regulation 139.020 from compliance with the provisions of Part 139 or specified standards set out in the Manual of Standards.

The Airside Operations Manager or delegate is responsible for applying to CASA for any exemptions that might be required and for their administration.

Current exemptions are listed below. Copies of these exemptions are held on file.

NO.	DATE	DESCRIPTION
EX02/17	24.02.2017	Electronic Surveillance Equipment fitted to vehicles

1.1.15 Current Agreements

- (a) Qantas Engineering requested installation of non-standard push-back markings on the Domestic Apron to improve visibility and tracking confidence during their push-back manoeuvres. The reduction to single engineer push-back manoeuvres highlighted the need to enhance these markings. Consultation with CASA resulted in their concurrence with the non-standard markings.
- (b) BAC requested clarification of certain apron line marking issues. E-mail correspondence and CASA's reply are held on file.
- (c) Subsection 2.1.2.3 of the MOS requires the airport operator to provide details in the Manual of existing aerodrome facilities that do not comply with the MOS Part 139. Facilities that do not comply are detailed in this section of the manual.
- (d) CASR 139.100 (3) states that if CASA approves, the Aerodrome Manual may consist of more than one document. CASA approval held on file.

1.1.16 Current Variations

The following facilities do not comply with the standards currently published in the CASA Manual of Standards Part 139 – Aerodromes.

Existing Facility	Constructed	MOS Standard	Expected Compliance
<p>TWY LIMA shoulders between TWY PAPA and TWY JULIET not sealed to a width of least 3metres</p>	1974	<p><i>MOS 139 6.3.10.1 (b)</i> If the taxiway is intended to serve a wide body jet, such as a Boeing 747 aeroplane or Airbus 380 aircraft, being an aircraft whose engines overhang the shoulders — sealed to a width of at least 3 metres on both sides of the taxiway. Facility complies with the standard of the day; <i>'Airport Engineering Instructions, Volume II – Part 4 – Section 9.12.2</i></p>	<p>When a major reconstruction of the TWY is undertaken. (Est. 2030) Interim safety measures are tightly bunded grass shoulders; Outboard engines to idle refer ERSA Local Traffic Regulation (7). Limited 4 engine aircraft taxing under power, most under tow.</p>
<p>Runway 01R/19L Gable marker</p> <p>The use of non-standard flush gable markers at runway 01R/19L strip end.</p>	1990	<p><i>MOS 139 8.2.2</i> The Use of Markers on a Runway Strip <i>MOS 139 8.2.2.2</i> Runway strip markers must be white, and may be gable, cone or flush. Gable markers are preferred, and flush markers must only be used where runway strips overlap. The spacing of gable or cone side strip markers must not exceed 180 m or 90 m respectively, as shown below.</p>	<p>Safety measure due Jet blast. Approval – Non-standard use of markers on runway strip, Instrument Number; CASA.ANAA.0017.02 21December 2016</p>
<p>RWY 01R/19L MAG signs</p> <ol style="list-style-type: none"> MAG signs 22.5m offset for 60m Code F runway applied for 45m runway width. MAG signs permitted to meet the ICAO frangibility standard requirements 	2017	<p><i>MOS 139 8.6.4.1 – table 8.1-1</i> Perpendicular distance from defined runway pavement edge to nearside of sign. Code 4 runway: 8-15m <i>MOS 139 8.6.5.1</i> MAGS must be lightweight and frangible mounted. They must be constructed so as to withstand a wind velocity of up to 60 m/sec without sustaining damage. Mounting must be constructed so as to fail, for frangibility requirements, under a static load not exceeding 8 kPa distributed over the sign face.</p>	<p>CASA approves locating the MAGS for 45m runway 01R/19L at a perpendicular distance of 22.5m from the defined runway pavement edge to the near side of the sign, instrument number CASA 37/17.CASA approves use of MAGS for runway 01R/19L that meet the standards in paragraphs 4.9.5 and 4.9.6 of ICAO document 9157 AN/901, Aerodrome Design Manual Part 6 – Frangibility, first edition, 2006, as it exists on the day this instrument number CASA 37/17 is signed.</p>

<p>Illuminated Wind Directions Indicators (IWDIs)</p> <p>3 of 4 IWDI Non-conforming locations and distance from threshold</p>	<p>1990</p>	<p><i>MOS 139 8.7.1.6</i> A wind direction indicator provided at the threshold of a runway must be located:</p> <ul style="list-style-type: none"> (a) except if it is not practicable to do so, on the left hand side of the runway as seen from a landing aircraft; and (b) outside the runway strip; and (c) clear of the transitional obstacle limitation surface. <p><i>MOS 139 8.7.1.7</i> If practicable to do so, a wind direction indicator provided at the threshold of a runway must be located 100 metres upwind of the threshold.</p>	<p>Safety measure to remain outside ILS critical areas and to meet aircraft separation clearances requirements.</p>
<p>TWY M2</p> <p>TWY M2 currently has a change in grade of 1% in 23m. This curve affects a section of taxiway 32.4m In length.</p>	<p>1988</p>	<p><i>MOS 139 6.3.4.2</i> If slope changes cannot be avoided, the transition from one longitudinal slope to another must be accomplished by a vertical curve, with a rate of change not more than:</p> <ul style="list-style-type: none"> (a) if the taxiway's code letter is C, D, E or F — 1.0% per 30 m (minimum radius of curvature of 3,000 m); 	<p>When a major reconstruction of the TWY is undertaken. (Est. 2040).</p> <p>Interim mitigation measures: Low use taxiway, servicing single maintenance hangar. Aircraft usually under tow. No reported issues from Qantas (occupier of the hangar). No reported incidents since construction.</p>
<p>Non Standard use of line marking contrast</p>	<p>1990</p>	<p><i>MOS 139 8.1.4 Visibility</i> <i>8.1.4.1 – Markings must be clearly visible against the background upon which they are placed. When required, on a surface of light colour, a contrasting black surround must be provided: on a black surface, a contrasting white surround must be provided.</i> <i>8.1.4.2 – Where provided, the width of surround colour must ensure an adequate visibility contrast. In the case of the line markings, the width of surround on either side of the marking must not to be less than the line width.</i></p>	<p>CASA approves Brisbane Airport to provide contrasting black surround width on either side of the primary marking to be not less than:</p> <ul style="list-style-type: none"> (a) Line Marking less than 0.3m – Contrast to be no less than width of the line marking (b) Line marking greater than 0.3m – Contrast to be no less than 0.3m

<p>Location of Taxiway Centreline Lights on Exit Taxiways A3, A4, A7 & M</p> <p>Currently spaced at 15m</p>	<p>1990</p>	<p>9.13.9 Location of Taxiway Centreline Lights on Exit Taxiways</p> <p>9.13.9.1 Taxiway centreline lights on exit taxiways, other than rapid exit taxiways, must:</p> <ul style="list-style-type: none"> A. start at the tangent point on the runway; B. have the first light offset 1.2 m from the runway centreline on the taxiway side; and C. (c) be spaced at uniform longitudinal intervals of not more than 7.5 m. 	<p>TWY A3, A4, A7 & M will be upgraded as part of the Low Vis/ Stop Bar project 2019.</p>
---	-------------	--	---

References

CASRs

139.105 Amendments of aerodrome manual

139.145 Aerodrome manual procedures

139.250 Safety management system

MOS Part 139 – Aerodromes

Chapter 1 Introduction

Chapter 2 Application of Standards to Aerodromes

Chapter 3 Applying for an Aerodrome Certificate

Chapter 4 Applying to Register an Aerodrome

Chapter 5 Aerodrome Information for AIP

Chapter 6 Physical Characteristics

Chapter 7 Obstacle Restriction and Limitation

Chapter 8 Visual Aids provided by Aerodrome Markings, Markers, Signals and Signs

Chapter 9 Visual Aids provided by Aerodrome Lighting

Chapter 10 Operating Standards for Certified Aerodrome

Chapter 11 Standards for Other Aerodrome Facilities

Part 2

Section 2 - Aerodrome Emergency Plan

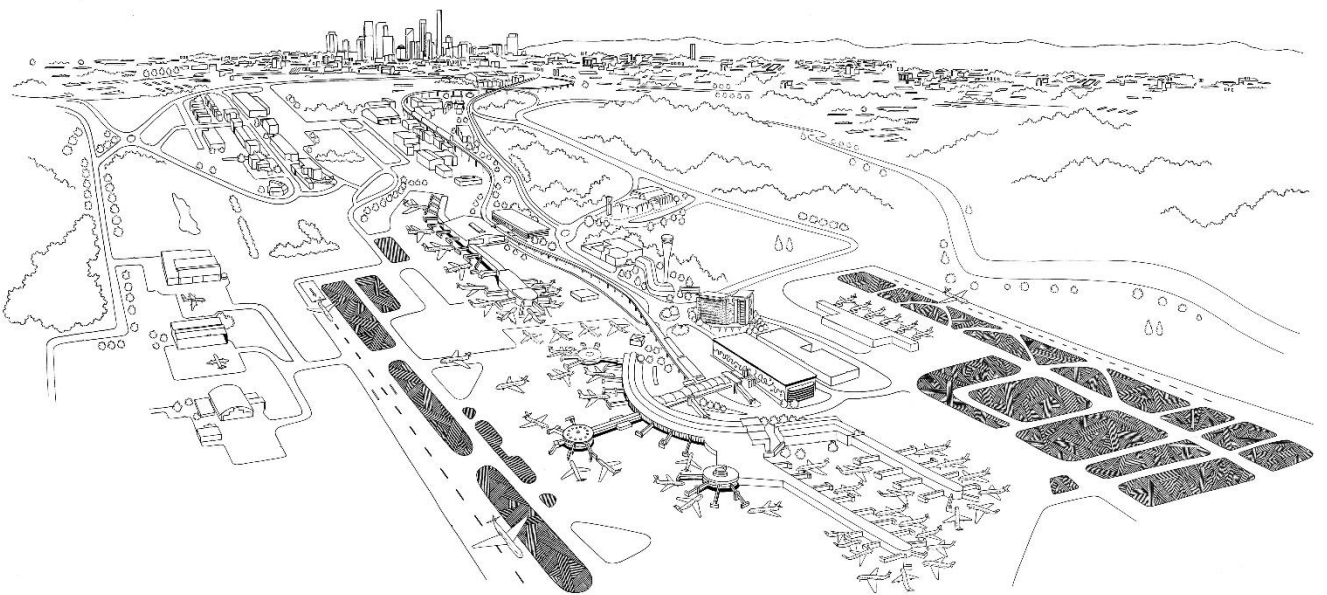

2.2 Aerodrome Emergency Plan (AEP)

To meet the requirements of Appendix 1 to CASR subparagraph 139.095(a) (ii), this section deals with the particulars of the Aerodrome Emergency Plan including details of the following:

- i. purpose and objectives for the Airport Emergency Committee (AEC) are set out in:
Section 2.1 of the AEP
- ii. key responsibilities of each emergency service organisation involved in the plan set out in:
Section 1.8 of the AEP
- iii. activation, control and coordination of the emergency service organisations are set out in:
Section 2 of the AEP
- iv. aerodrome emergency facilities and arrangements for keeping them in readiness are set out in:
Section 3 of the AEP
- v. management arrangements, including the location of emergency assembly areas for the marshalling of off aerodrome response resources are outlined in:
Section 4.3 of the AEP
- vi. response to local stand-by call outs are set out in:
Section 4.5 of the AEP
- vii. response to full emergency outs are set out in:
Section 4.6 of the AEP
- viii. arrangements to return the aerodrome back to operational status after an emergency are set out in:
Section 5.3 of the AEP
- ix. arrangements for periodic review (at least annually) of the AEP are set out in:
Section 1.7 of the AEP
- x. arrangements for testing the AEP are set out in:
Section 1.5 of the AEP

The Brisbane Airport 'Aerodrome Emergency Plan' (AEP) details the arrangements for the coordination of the activation, response, and initial recovery process for any incident requiring response agencies within or adjacent to Brisbane Airport. This plan is also based on the assumption that every agency and aviation industry participant with a statutory responsibility has in place appropriate supporting Standard Operating Procedures which detail the agency's response in accordance with this plan. In accordance with CASR 139.100(3) the AEP has been adopted as Annex 2 to this Manual. It is understood that responding agencies will develop their own procedures for implementing the AEP.

References

CASRs

139.205 Aerodrome emergency committee

139.210 Aerodrome emergency plan

139.215 Testing of aerodrome emergency plan

MOS Part 139 – Aerodromes

Section 10.7 Aerodrome Emergency Planning

Section 10.8 Guidelines for Aerodrome Emergency Plans

Part 2

Section 3 - Aerodrome Lighting

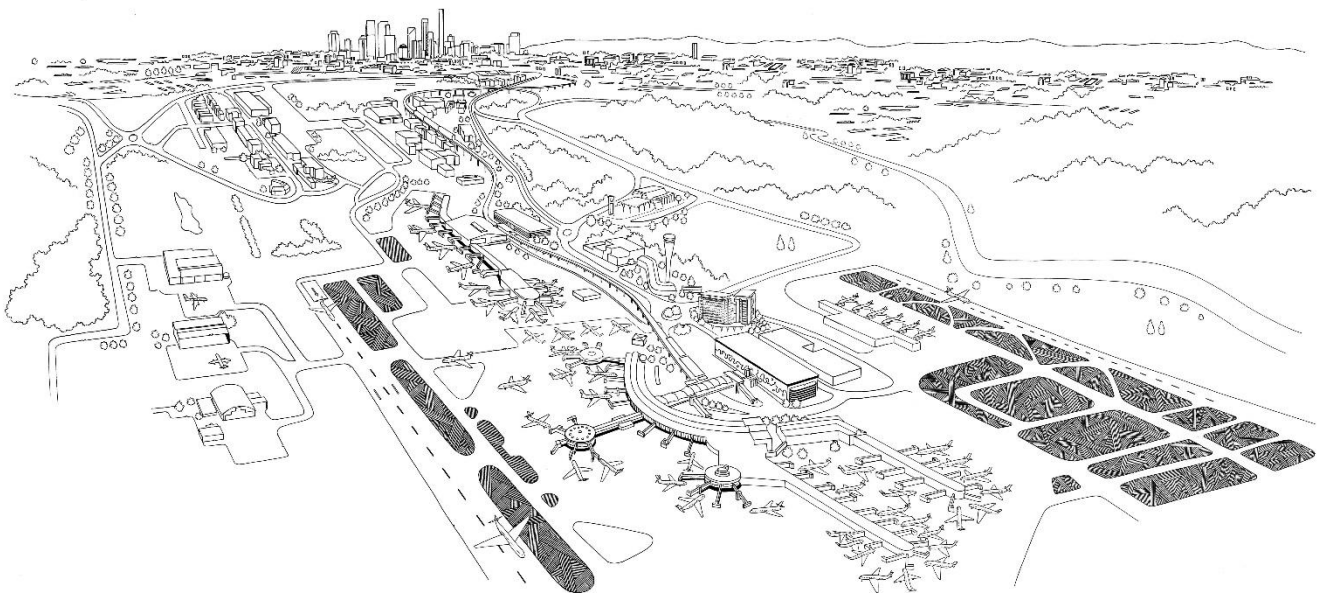

2.3 Aerodrome Lighting

To meet the requirements of Appendix 1 to CASR subparagraph 139.095 (a)(ii) this section deals with the particulars of the procedures for the inspection and maintenance of the aerodrome lighting (including obstacle lighting) and supply of standby power (if any) including details of the following:

An inventory/description of the aerodrome lighting system. Include design aircraft for PAPI

- (i) The arrangements for carrying out inspections and the checklist for inspections;*
- (ii) The arrangements for recording the results of inspections and for taking follow-up action to correct deficiencies;*
- (iii) The arrangements for switching lights on and off, including back-up arrangements for pilot-activated lighting;*

Details of location of switches and PAL cabinets, switching procedures etc.

- (iv) The arrangements for carrying out routine maintenance and emergency maintenance;*

Determine and specify a minimum spares holding list.

- (v) The arrangements for providing secondary power, stand-by power and portable lighting if any.*

Include details of lights provided for runway, taxiway, apron closure, displaced thresholds etc.

- (vi) The titles and roles of the persons who are responsible for the inspection and maintenance of the lighting. The telephone numbers for contacting these persons must be included in the master contact list.*

2.3.1 Aerodrome Lighting Inspections

The arrangements for carrying out inspections and the check list for inspections:

A regular inspection and maintenance program is undertaken to ensure the appropriate brightness and the intensity of individual light fittings, and the reliable operation of the complete lighting system;

Inspection frequencies and maintenance requirements are programmed in the BAC Computerised Maintenance Management System (CMMS) designed specifically for Brisbane Airport.

- Inspection Frequencies are:
- PAPI's monitored Daily/Nightly
- Inspected Weekly (Saturday Night)
- APPROACH LIGHTING: Monitored: When outages are identified
- Inspected: Inspected Weekly (Saturday Night)

2.3.2 Serviceability and performance inspections:

Serviceability inspections of the airport lighting facilities (including obstacle lights) are carried out by the duty Aerodrome Reporting Officer as specified in *Part 2, Section 6 Aerodrome Serviceability Inspections* of the Manual. He/she uses Tracker Airside to record the inspections undertaken.

2.3.3 Technical inspections:

Technical inspections of the airport lighting facilities are based on the requirements of MOS Part 139 Chapter 9 and the Airport Lighting Equipment Handbooks, Vol. 1-17;

The Airfield Maintenance Technical Officers conducts the monthly technical inspection of the standby generating plant in conjunction with Airport Lighting staff.

2.3.4 Recording Inspection Results

The arrangements for recording results of inspections and for taking follow-up action to correct deficiencies are:

- All obvious defects or damage noted during the daily serviceability inspections are reported and recorded in Tracker Airside;
- The duty Airside Operations Team Leader/Officer inspects and reports on individual light fitting unserviceability's each Saturday night through Tracker Airside. This is forwarded to the Facilities Maintenance Department upon completion.
- Airport Lighting section staff record equipment faults and repair details in the appropriate Airport Lighting equipment room logbook and enter the appropriate airport lighting equipment faults in the CMMS;
- Standard reports confirming all tests of airport lighting facilities and maintenance history can be generated from the CMMS as required;
- Airservices Australia's Technical Customer Interface (TCI) monitors and reports airport lighting system fault conditions;
- Faults detected during normal working hours by ATC, the TCI or other sources are reported to the Airfield Maintenance Technical Officers as the first point of contact or, alternatively, Airside Operations Centre. ATC categorizes the fault and notifies the duty Aerodrome Reporting Officer;
- Faults detected after hours are reported to the duty Airside Operations Team Leader who in turn contacts appropriate BAC staff;
- Airport Lighting staff assess priorities for repairs and ensure that all airport lighting equipment is maintained at a serviceable standard in accordance with MOS 139, Chapter 9.20.

2.3.5 Lighting Backup

The arrangements for switching lights on and off, including back-up arrangements for pilot activated lighting:

- ATC operates the airport lighting for aircraft use, by direct switching at the Control Tower console;
- In an emergency, or if the primary switching mechanism fails, Airfield Maintenance Technical Officers will operate the lighting by local switching, under direction of ATC. In normal circumstances BAC operates the lighting only for maintenance purposes. These requirements are coordinated with ATC;
- BAC has provided interlock switching to prevent the high intensity approach lighting for both runway 01R and 19L operating at the same time;
- Apron floodlighting on the International, Domestic, Logistics and General Aviation aprons is normally operated by daylight control switching.

2.3.6 Routine Maintenance

The arrangements for carrying out routine maintenance and emergency maintenance:

- Routine maintenance of the airport lighting facilities are based on the requirements of *MOS Part 139 Chapter 9 and the Airport Lighting Equipment Handbooks, Vol. 1-17*;
- The airport lighting maintenance schedule and tasks are programmed into the CMMS;
- The Fleet and Mechanical Coordinator conducts the monthly test run of the standby generating plant in conjunction with Airport Lighting staff;

- Prior to the beginning of each month the Airport Lighting staff generates a standard report from the CMMS which details the maintenance to be performed for each lighting system in that month. He/she raises Work Orders for each scheduled task and closes each Work Order as the maintenance is completed;
- Before any airport lighting facilities are withdrawn from service for maintenance, test switching or other purpose, Airport Lighting staff co-ordinate their requirements with ATC and TCI. In all cases ATC and TCI are advised of the expected unavailability and recall times for the particular airport lighting equipment;
- If faults are found during routine maintenance which render airport lighting equipment unserviceable, BAC notifies ATC and TCI of the details of the fault and expected unserviceability times. This also applies if system failure is detected during the daily serviceability inspection;
- ATC and TCI are advised on completion of maintenance and the return of equipment to service;
- Maintenance of airport lighting generating plant is coordinated in the same manner;
- In an emergency, electrical maintenance staff are on call at all times and are contacted by the duty Aerodrome Reporting Officer at Airside Operations Centre.

2.3.7 Routine Maintenance

Arrangements for stand-by power, if any, and if applicable, particulars of any other method of dealing with partial or total and system failure:

- During extended mains power failures and loss of local generating plant, power may be supplied from portable external generating plant.

2.3.8 Aerodrome Lighting Facilities

Details of airport lighting facilities provided by BAC at Brisbane Airport are included in AIP-ERSA. Full details of the airport lighting and associated cabling are maintained on a CAD data base by BAC Assets Group;

- BAC has installed internally illuminated mandatory movement area guidance signs (MAGS), PAPI system and information signs along with Runway Guard Lighting (RGL) for the 01R/19L Runway system;
- Airservices Australia owns and maintains the Airport Rotating Beacon located on the roof of the Control Tower, and the Air Traffic Control (ATC) Signal Light located in the Control Tower cab;
- Details of the airport lighting installation are shown on the BR-141 400 series of plans held by the Electrical Maintenance Officers. Full details of the airport lighting and associated cabling are maintained on the CAD database.

2.3.9 Obstacle Lighting

- Obstacle lights are installed on a number of structures within the horizontal limits of the Brisbane Airport obstacle limitation surfaces (OLS). Technically some of these are not obstacles as they do not infringe the OLS. A plan identifying these obstacle lights is included as an attachment to *Part 2, Section 6 Aerodrome Serviceability Inspections* of this Manual;
- Obstacle control and lighting is also dealt with in *Part 2, Section 12 of the Manual*.

2.3.10 Apron earthing points

- The CMMS contains details of all apron earthing points. Routine inspections of earthing points are recorded in the CMMS.
- Apron earthing points are inspected visually every 3 months and resistance tested at 12 month intervals. Earthing points that fail to comply with the resistance to earth requirement of not exceeding 10 000 ohms

are indicated with a red circle and programmed for repair. All serviceable earthing points are identified with a white painted circle.

2.3.11 Planning, installing and maintaining new and existing equipment

- New and existing airport lighting facilities are planned, installed and maintained in accordance with *MOS Part 139, Chapter 9, ICAO Annex 14* and manufacturer's handbooks. BAC also obtains prior agreement from CASA and/or Airservices.
- Before certain lighting facilities are put into operation and where appropriate they are:
 - (a) checked by qualified Airport Lighting section staff;
 - (b) surveyed by a suitably qualified person; and/or
 - (c) flight checked by a CASA approved pilot (where requested).
- The results of the checks are forwarded to CASA for approval of the issue of a permanent NOTAM (followed by publication in AIP-ERSA).

2.3.12 Roles and Responsibilities

The names and roles of the persons who are responsible for the inspection and maintenance of the lighting and the telephone numbers for contacting them during and after working hours:

- The Civil Assets Manager ensures that the airport lighting system is appropriate for the intended level of aircraft operations at night and during low visibility operations, and that standby power generating equipment is provided;
- Where CASA determines that a permanent or temporary obstacle such as a building or a construction crane requires lighting, the owner/operator is required to install, operate and maintain the appropriate obstacle lights;
- The Department of Infrastructure & Transport may also require the owner/operator of a permanent or temporary obstacle to install, operate and maintain appropriate obstacle lights as a condition of approval to carry out a "controlled activity" under the *Airports Act 1996*;
- The Civil Assets Manager programs, co-ordinates and/or directs the technical inspections and maintenance of airport lighting facilities using the CMMS. All inspections and maintenance are recorded in the CMMS. All faults other than routine lamp failures are recorded in the CMMS;
- The Airport Lighting Coordinator maintains and directs the technical inspections of the airport standby power generating systems using the CMMS. All inspections and maintenance are recorded in the CMMS;
- Aerodrome Reporting Officers carry out daily visual inspections to monitor defects, damage or unusual operation that affect the serviceability of airport lighting (including RGL), illuminated visual aids and obstacle lights. The results of these inspections are notified to the Airport Lighting section of BAC;
- The telephone numbers of BAC staff nominated in this procedure are provided on the Telephone Contact List at the front of the Manual.

References

CASRs

139.190 *Visual approach slope indicator system*

139.195 *Lighting of movement area*

139.200 *Checking of lighting systems*

MOS Part 139 – Aerodromes

Chapter 9 *Visual Aids Provided by Aerodrome Lighting*

Section 10.2.4 *Aerodrome Markings, Lighting, Wind Direction Indicators and Ground Signals*

Other

Airport Lighting Equipment Handbooks (Vols. 1 – 17)

Part 2

Section 4 - Aerodrome Reporting

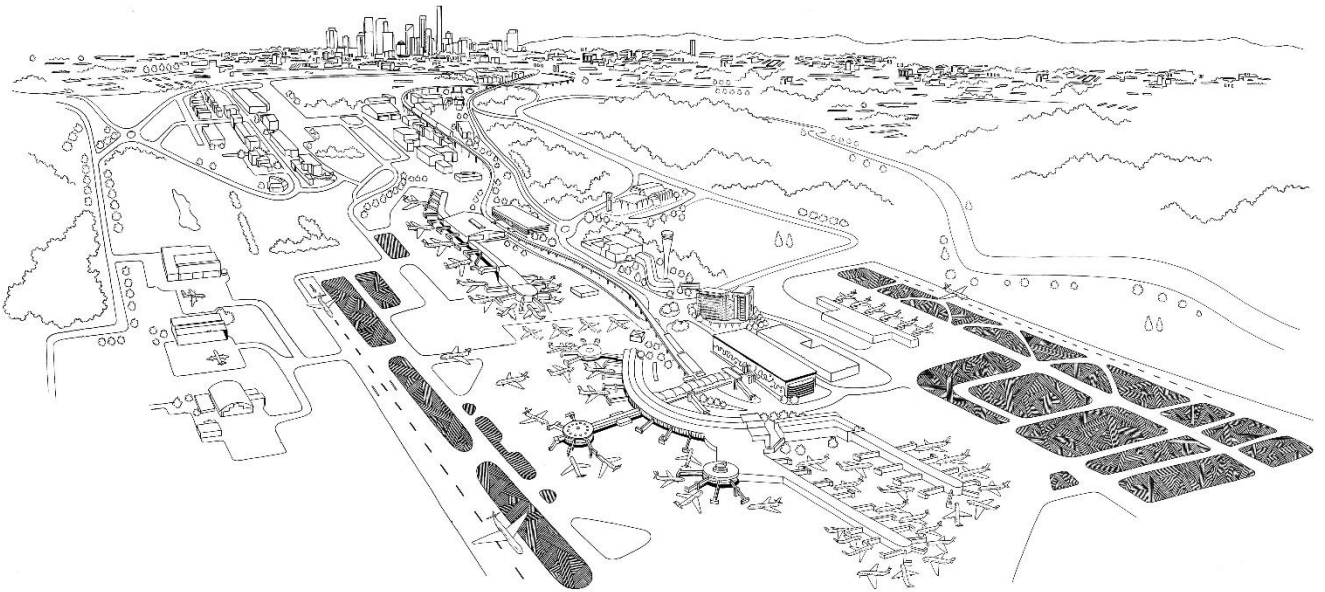

2.4 Aerodrome Reporting

To meet the requirements of Appendix 1 to CASR subparagraph 139.095(a) (ii) this section deals with the particulars of the procedures for reporting any changes including;

- (i) *The arrangements for reporting any changes that may affect aircraft operations to AIS and local air traffic services and recording the reporting of changes during and outside the normal hours of aerodrome operation;*
- (ii) *Details of the persons and organisations to which changes are to be reported. The telephone numbers for contacting these persons must be included in the master contact list.*
- (iii) *The titles and roles of the persons who are responsible for aerodrome reporting. The telephone numbers for contacting these persons must be included in the master contact list.*

Include procedure for raising temporary and permanent NOTAMs.

Include procedure for advising NOF of Reporting Officers names and keeping list current.

- (iv) *The arrangements for reporting and filing changes of aerodrome information published in AIP to AIS and CASA;*

Changes to physical conditions

Changes to published information

Obstacle information

If applicable changes to serviceability of AFRU and PAL.

- (v) *The arrangements for keeping records of reports made in respect to NOTAMs and AIP amendments.*

File copies of NOTAM requests and the published NOTAMs

Establish how confirmation of issued NOTAMs is obtained from Airservices Australia.

2.4.1 Reporting Requirements

Tracker Airside is utilised by BAC Airside Operations to record, track and influence aerodrome compliance, safety, incident management, operational maintenance and overall aerodrome analytics. The types of changes that may affect aircraft operations and require reporting are:

- those which affect the availability or serviceability of the maneuvering area (aprons are not usually subject to NOTAM action unless the problem is significant, i.e. stands not available, or there is an effect on nearby taxiways);
- a change in the aeronautical information published in the AIP-ERSA;
- airport works which affect the maneuvering area or the OLS;
- temporary obstacles to aircraft operations;
- bird or animal hazards on or near the airport; or
- a change in the availability or serviceability of airport markings, visual aids, airport and other lighting.

2.4.2 Reporting Temporary Changes

The designated Reporting Centre for Brisbane Airport is:

- Air Traffic Control (ATC) for verbal reports;
- The Australian NOTAM Office (NOF) for NOTAM action.



Anything that may have an immediate effect on the safety of aircraft operations is reported to ATC in the first instance and then confirmed as quickly as possible by NOTAM.

In other cases ATC is also alerted to check that a NOTAM is issued. Attachment E (NOTAM Request) contains the standard Airservices Australia NOTAM Request Form including the contact details of the Reporting Centre (Airside Operations Centre).

Reports made to the NOF are advised by email through Tracker Airside or by using the standard NOTAM Request Form (Attachment E), although urgent reports may be made by telephone and confirmed by email later.

A standard NOTAM once issued to NOF, is stored electronically.

In most cases airport conditions or new obstacles that need to be reported immediately, will be detected during the daily serviceability inspections. The procedures for these inspections and requirements for logging the results of them are detailed in *Part 2, Section 6 (Aerodrome Serviceability Inspections)* of the Manual.

The Aerodrome Reporting Officer who detects a new obstacle which requires temporary changes in published information, advises the Airside Standards Manager (or delegate) to originate a NOTAM.

Obstacle NOTAMs are issued by approved BAC personnel pursuant to the delegation of powers under the *Airports Act 1996 and Airports (Protection of Airspace) Regulations 1996*. If revised declared distances are to be notified, the calculation is performed by two appropriately qualified BAC personnel so that an independent check can be made.

The NOTAM text emailed to the NOF is encoded using the standard word abbreviations and phrase contractions. Where an uncertainty exists in the encoding, the NOF can be supplied with simple English content, including the definition of start, duration and completion in local time format.



Attachment E - NOTAM Request Form

Submit by Email

Print Form

Airservices Australia NOTAM Request Form



To: Australian NOTAM Office Ph: 02 6268 5063

Fax: 02 6268 5044

Email: nof@airservicesaustralia.com

(Office use only) Group Originator NOTAM directory ERSA Qcode T/P/S INTL abbrev Summary line

FIELD A)	Location	<input type="text"/>
-----------------	-----------------	----------------------

NOTAM N	<input type="checkbox"/> New	
NOTAM R	<input type="checkbox"/> Replace (Extend/Amend)	NOTAM No. <input type="text"/>
NOTAM C	<input type="checkbox"/> CNL (Cancel)	NOTAM No. <input type="text"/>
NOTAM Office Template Number (if applicable): <input type="text"/>		

Date/Time Convention: Eastern Standard Central Standard Western Standard UTC/Zulu (preferred) Eastern Daylight Central Daylight

B) **Start Time** (date) (time) or Immediately (WIE)

C) **Finish Time** (date) (time) Confirmed (Self cancel)
 (Leave all blank for CNL NOTAM) or Permanent (PERM) Estimated (Needs REV/CNL)

D) Optional **Periods of Activity**

Examples: HJ, HN, H24, JF*, JO* (* cannot use internationally) or	<input type="text"/>	TO	<input type="text"/>
time TO time (for daily ops) or	<input type="text"/>	TO	<input type="text"/>
date/time TO date/time (for multiple periods)	<input type="text"/>	TO	<input type="text"/>
	<input type="text"/>	TO	<input type="text"/>
	<input type="text"/>	TO	<input type="text"/>
	<input type="text"/>	TO	<input type="text"/>

E) **Full Text of NOTAM N or NOTAM R** or **ONLY the First Line of NOTAM to be cancelled**
 FOR OBST NOTAM ONLY Not required No Yes
 OBST assessed by Airservices IFP? Assessment Code No impact

F) Optional	Lower Limit: <input type="checkbox"/> SFC or <input type="text"/> (Leave all blank for CNL)	<input type="checkbox"/> Flight Level <input type="checkbox"/> Feet AGL <input type="checkbox"/> Feet AMSL	G) Optional	Upper Limit: <input type="checkbox"/> * UNL or <input type="text"/> (Leave all blank for CNL)	<input type="checkbox"/> Flight Level <input type="checkbox"/> Feet AGL <input type="checkbox"/> Feet AMSL
--------------------	--	--	--------------------	--	--

Contact Name: Organisation:
 Phone: Fax:
 NOTAM Group Name: NAIPS User Name:
 Email:

Originator will check issued NOTAM by Return Fax NAIPS *Auto

ORIGINATOR MUST CHECK NOTAM FOR ACCURACY AFTER ISSUE

* automatic email transmission of NOTAM for my aerodrome has been arranged with the NOF

2.4.3.1 Reporting temporary changes:

- Air Traffic Control
Brisbane SMC on 121.7 MHz or ATC Team Leader
- Airservices Australia Reporting Centre
Australian NOTAM Office
25 Constitution Avenue
Canberra ACT 2600
Telephone: (02) 62685063 (24 Hrs)
Email: nof@airservicesaustralia.com

2.4.3.2 Reporting permanent changes:

- Airservices Australia - Aeronautical Information Service
GPO Box 367
CANBERRA ACT 2601
Telephone: (02) 6268 5668 Fax: (02) 6268 5689
Email: docs.amend@airservicesaustralia.com
- Civil Aviation Safety Authority (CASA)
Attention: District Airport Inspector
South Queensland Area Office
GPO Box 2005
Canberra ACT 2601
Telephone: 131 757
Fax: (07) 3144 7388

2.4.3.3 Reporting incidents and accidents

- Australian Transport Safety Bureau
PO Box 10024
Adelaide Street
BRISBANE QLD 4000
Telephone: (07) 3831 0628 or 1800 011 034 (24 hrs.)
Fax: (07) 3832 1386

2.4.3.4 The designated contacts for Brisbane Airport are:

- Airside Standards Manager;
- Airside Standards and works Coordinator;
- Airside Coordination Manager;
- Airside Safety Systems Manager;
- Airside Wildlife Coordinator;
- Airside Operations Team Leaders; and
- Aerodrome Reporting Officers.

These officers meet the training requirements of MOS Part 139, Section 10.6. A training plan has been developed to meet and in some areas exceed the minimum requirements to attain a Certificate 3 in Aviation Operations. Their names and contact details are provided on the Telephone Contact List at the front of the Manual.

2.4.4 Reporting changes published in AIP to AIS and CASA

These sorts of changes will be detected during a technical inspection (see Part 2, Section 7) or result from new works affecting published information.

Permanent changes in operational information are reported by the Airside Operations Manager, or delegate.

The Airside Standards Manager or delegate advises AIS (Airservices Australia) of change(s) to aerodrome information for publication in the AIP via docs.amend@airservicesaustralia.com. He/she also provides this advice to the CASA District Airport Inspector for Brisbane Airport.

If the change in published information has an immediate effect on aircraft safety, appropriately qualified Airside Operations personnel also requests the NOF to raise a temporary NOTAM pending permanent notification through the AIP.

2.4.5 Record Keeping

All NOTAM action requested subsequent to the daily serviceability inspection is recorded in the Aerodrome Reporting Officers Logbook within Tracker Airside. These records include but are not limited to:

- time of the inspection;
- details of the unserviceability or temporary obstacle; and
- details of the NOTAM advice made to the Airside Standards Manager, or delegate, Airside Operations Manager, or delegate and/or General Manager Operations, or delegate.

The standard NOTAM Request Forms, once issued to NOF, are stored electronically.

For permanent changes in aeronautical information the Airside Standards Manager, or delegate retains all correspondence exchanged by BAC, CASA, AIS and the NOF.

2.4.6 Reporting Incidents and Accidents

The Aerodrome Reporting Officers report any significant object found in the course of a daily serviceability inspection through Tracker Airside.

If the object is known or thought to be an aircraft component, it is reported immediately to ATC and Duty Terminal Manager (DTM) so that an attempt can be made with the Airline to alert the pilot of the aircraft that may have been involved. The Aerodrome Reporting Officer may seek the advice of a licensed aircraft maintenance engineer on the airport, in making this decision.

If requested by ATC, the duty Aerodrome Reporting Officer also searches for component parts reported to have fallen from an aircraft. Details of these aviation incidents are recorded in the Aerodrome Reporting Officer's Tracker Airside, and reported to the Airside Operations Manager, or delegate, who determines what follow up actions are necessary.

He/she decides whether an Air Safety Incident Report needs to be completed and forwarded to ATSB.

Bird strikes and/or carcasses are reported in accordance with the procedures detailed in Part 2, Section 11 (Wildlife Hazard Management) of the Manual.

The General Manager Operations (or a delegate) directs internal investigations into aviation incidents involving BAC staff.

2.4.7 Reporting obstacle penetrations of PANS-OPS surfaces

The Airside Standards Manager notifies Airservices Australia (Procedure Design Department) of any change in status of existing critical obstacles and any proposed development that is likely to be higher than the critical obstacles.

2.4.8 NOTAM

NOTAM is an acronym for “Notice(s) to Airmen”. They are used to advise pilots and other persons concerned with flying operations about matters of an urgent nature that may affect the safety of aircraft operations. In relation to an airport this includes temporary changes in published information, unserviceability's, or newly detected obstacles.

- NOTAM includes the following information:
- name of the airport;
- a description or identification of areas affected;
- reason for unserviceability or change;
- restrictions that apply; and
- expected duration.

Because of the wide range of NOTAM it is not practicable to establish a rigid standard format for their composition. The information included should be a brief but complete report of the facts.

References

MOS Part 139 – Aerodromes

Section 10.2 Inspecting and Reporting Aerodrome Serviceability

Section 10.3 Initiation an NOTAM

Section 10.4 Sample Aerodrome Report Form

Section 10.5 Examples of NOTAM and Listing of Abbreviations

Section 10.6 Appointment of Reporting Officers

Section 7.1.7 Monitoring of Obstacles Associated with Instrument Runways

Section 7.1.8 Additional Obstacle Assessment for an Existing Non-Instrument Runway to be upgraded to a Non-precision Instrument Runway

Part 2

Section 5 - Unauthorised Entry to Aerodrome

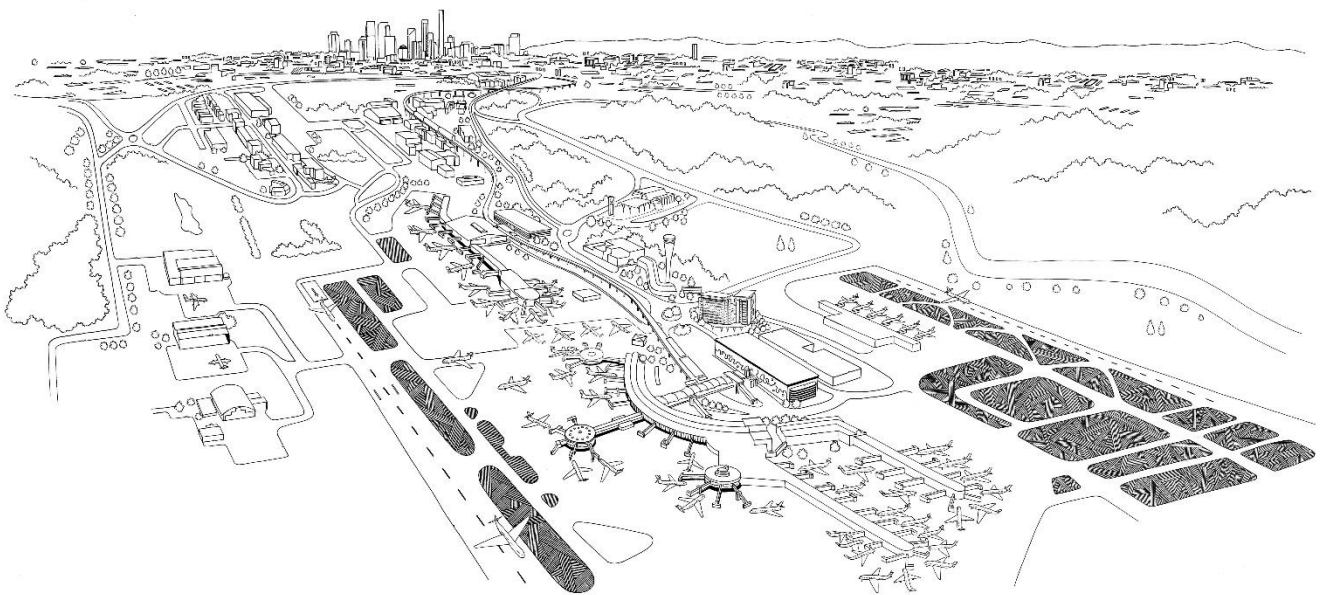

2.5 Unauthorised Entry to Aerodrome

To meet the requirements of Appendix 1 to CASR subparagraph 139.095(a)(ii) this section deals with the particulars of the procedures for preventing the unauthorised entry of persons, vehicles, equipment, plant or animals, or other things that may endanger aircraft safety, into the movement area including details of the following:

- (i) Arrangements for controlling airside access;
 - Authorised access e.g. key register, passes etc.
 - Physical control methods e.g. fences, gates etc.
 - Method of monitoring and recording unauthorised entry
- (ii) The names and roles of the persons who are responsible for controlling access to the movement area. The telephone numbers for contacting these persons must be included in the master contact list

The Brisbane Airport Transport Security Program is published and distributed independently of the Aerodrome Manual. It is a restricted document and this section contains only such information as is necessary to meet the requirements of the CASRs. In accordance with CASR 139.100(3) the Transport Security Program has been adopted as Annex 3 to this Manual.

2.5.1 Arrangements for controlling airside access

2.5.1.1 Airside Security

No person is permitted airside without lawful excuse. Whilst in security restricted areas and zones, including airside, they must display a valid Aviation Security Identification Card (ASIC) or a Visitor Identification Card (VIC) and be supervised/escorted by an ASIC holder.

The active and passive security measures adopted by BAC under the Transport Security Program are designed to prevent unauthorised access. Aerodrome Reporting Officers carry out random ASIC and vehicle checks of people and vehicles on the airside and coordinate the removal of those there without authority. Breaches are recorded in the OCA Noggin.

2.5.1.2 Airside Vehicle Access and Airside Driving

Airside vehicle access is governed by the provisions of *Part 2, Section 10 Airside Vehicle Control* of the Manual, and the *Airside Drivers Handbook*.

Air Traffic Control approval is required for access to the maneuvering area. Access is limited to those persons who hold, or are escorted by a person who holds, a Category 3 or Category 3-RWY Authority to Drive Airside - *Part 2, Section 10 Airside Vehicle Control* of the Manual.

2.5.1.3 Animals Airside

Animals are only permitted airside if caged or restrained. *Part 2 Section 19 of the Aerodrome Manual* details procedures for livestock loading, unloading and transfers. These include provision to cull animals which may escape airside during loading or unloading operations. If a domestic or feral animal is found airside, the duty Airside Operations Team Leader/Officers may cull it immediately if it threatens the safety of aircraft operations. This is recorded in Tracker Airside

2.5.1.4 Airside Access

Airside access is generally controlled by a standard security fence. In areas where additional deterrents are required, razor wire is installed. Gate locations are as shown on the plan included as Attachment A.

The AIP (Airside Inspection Point) is the primary airside access point on Ghania Street, off Airport Drive and is also the emergency services assembly point. Gate 12 on the Eastern side of the airfield is a secondary Emergency Services assembly point and can be accessed by swipe enabled ASIC with BAC authorisation. All electronic gates on airport are controlled by proximity card readers. Remaining gates are padlocked.

Airside access through the common user areas of the Domestic Terminal is controlled by a proximity activated card reader system. Airside access through the International Terminal is controlled by the same proximity card system.

The Operations Group authorises the issue of ASIC access cards and keys. Cards and keys are issued in accordance with the Transport Security Program.

Restricted access signs are located in buildings that provide direct airside access, at each access gate and at regular intervals along the boundary fence. The wording and location of these signs is in accordance with the Aviation Transport Security Regulations 2005.

2.5.1.5 Airside Boundary

All new security fencing is required to meet BAC planning guidelines. Any changes to the security fence line and/or the access barriers to the airside security areas require approval through the Approvals Section.

Patrols of the airport perimeter fence are conducted on a regular basis 24/7.

2.5.1.6 Airside Security Roles and Responsibilities

The Managing Director/CEO has overall responsibility for aviation security and for the control of airside access to the airport.

The General Manager Operations or delegate ensures that a Transport Security Program is prepared for approval by the Department.

This includes the establishment of an Airport Security Committee and Consultative Group and the appointment of a BAC Security Contact Officer (SCO). At Brisbane Airport, this appointment is filled by the Security Operations Manager.

The Security & Emergency Planning Manager implements those aspects of the Transport Security Program that control airside access to the airport.

The Department liaises with BAC, airlines, airport tenants, the Australian Federal Police (AFP), Queensland Police Service (QPS) and other relevant parties on security matters; and provides policy advice to airport management and the respective Airport Security Committees on aviation security matters.

The Australian Federal Police (AFP) are responsible for:

- Command and control of AFP response and coordination of Commonwealth agencies;
- Counter Terrorist First Response (CTFR);
- Aviation law enforcement liaison;
- Investigation of aviation matters;
- Management of aviation intelligence and information;
- General duties policing.

AFP has primacy for the initial law enforcement response to aviation security and emergency incidents and coordinates with the QPS. In circumstances where AFP resources are insufficient, incidents will be handed over to the QPS in accordance with relevant Queensland Government Acts and Orders, which have effect under the Commonwealth Places (Application of Laws) Act 1970.

Airline operators are also responsible for prevention of unauthorized airside access via any sector of the airport under their direct control, e.g. passenger terminals, aircraft hangars, workshops, buildings and licensed aprons.



Airport tenants and lessees are responsible for controlling airside access via their buildings and/or leased areas. They are required to establish and enforce procedures to prevent unauthorized airside access through these areas, in accordance with their and BAC's Transport Security Programs (TSP).

The telephone numbers of BAC staff nominated in this procedure can be found on the Telephone Contact List at the front of the Manual.

References

MOS Part 139 – Aerodromes

Section 10.9 Control of Airside Access Including Vehicle Control

Part 2

Section 6 - Aerodrome Serviceability Inspections

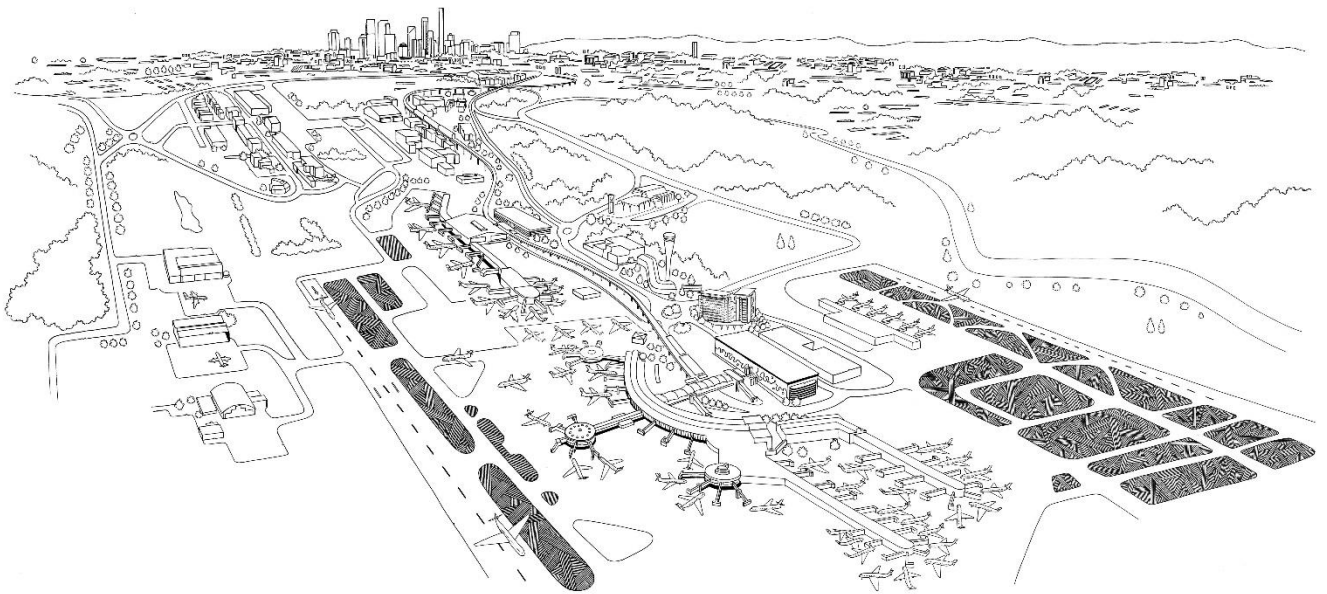

2.6 Aerodrome Serviceability Inspections

To meet the requirements of Appendix 1 to CASR subparagraph 139.095(a) (ii) this section deals with the particulars of the procedures for Aerodrome Serviceability Inspections, including details of the following

The arrangements for carrying out the inspections during and after working hours;

- (ii) Details of the intervals at which the inspections are carried out and the times of the inspections;
- (iii) The arrangements for keeping an inspection log, what form it takes and the place where it is kept;
- (iv) Details of the inspection checklist;
- (v) The arrangements for communicating with air traffic control, broadcasting intentions on MBZ or monitoring area traffic during the inspections;
- (vi) The arrangements for reporting the results of the inspections and for taking prompt follow-up action to ensure correction of unsafe conditions;
 - Records of corrective action requests, follow up action and acquittal.
 - Arrangements for initiating a Technical Inspection if required following a serviceability inspection.
- (i) The titles and roles of the persons who are responsible for serviceability inspections. The telephone numbers for contacting these persons must be included in the master contact list

Aerodrome Reporting Officers/Team Leaders are responsible for carrying out serviceability inspections on a continuous basis covering the entire movement area and zones adjacent to the airport boundary complying as per *Civil Aviation Safety Regulations (139.125, 220,225)* and of the *Airside Operations, Standard Operating Procedures Section 3 Serviceability Inspections*.

2.6.1 Aerodrome Serviceability inspections during and after working

Aerodrome serviceability inspections are recorded through Tracker Airside (figure 5 and Figure 6). Results of the airport serviceability inspections are recorded in Tracker Airside. The start and finish time is recorded for each item inspected on the log sheet. The Aerodrome Reporting Officer enters details of deficiencies found and/or provides comments or a detailed report as appropriate.

Aerodrome Reporting Officers conduct routine serviceability inspections of the movement area, airfield lighting and the OLS. They work a 24 hour roster to ensure continuous monitoring and maintenance of airport serviceability.

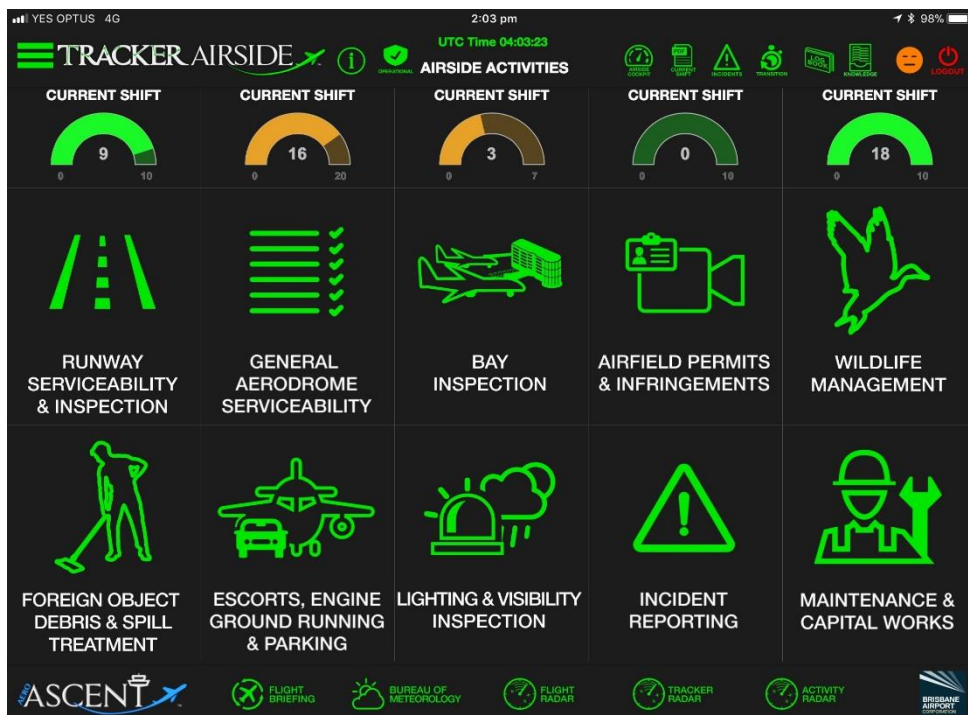

Figure 5 – Tracker Airside



Figure 6 – Tracker Airside

2.6.2 Specific Serviceability Inspections

Specific serviceability inspections are also carried out at the request of Air Traffic Control (ATC), especially;

- after a major incident or crash involving closure of a runway,
- after severe storms, a report of foreign object(s) on the runway,
- after pavement damage or bird strikes.

Inspections are also undertaken on an ad hoc basis to identify specific problems related to:

- airport works;
- potential jet blast impacts;
- runway visibility assessment;
- disabled aircraft; or
- Overheating of aircraft wheels.

2.6.3 Routine serviceability inspections

Routine serviceability inspections include checks on:

- movement area status;
- runways (including lighting (RGL) and runway strips);
- taxiways (including lighting) and taxiway strips;
- aprons (including lighting);

- perimeter fences;
- the approach, take-off & transitional surfaces & the inner horizontal surface of the OLS;
- obstacle lights/hazard beacons generally within the horizontal limits of these surfaces of the OLS;
- bird & wildlife hazards;
- FOD; and
- Pavement defect hazards.

2.6.4 Lighting serviceability inspections

During the nightly serviceability inspection, the duty Aerodrome Reporting Officer routinely checks obstacle lights/hazard beacons visible from the ground. He/she checks weekly on the additional lights/beacons visible from the control tower cabin. BAC staff do not monitor lights/beacons on structures below the vertical limits of the OLS. The duty Aerodrome Reporting Officer also completes a full “lights out” night inspection report on airport lighting each week.

2.6.5 Lighting serviceability inspections

If the duty Aerodrome Reporting Officer detects a pavement defect or anomaly, details are also recorded as described in *Part 2, Section 4* of the Manual.

Details of how the Serviceability Inspections are carried out are listed in the *Airside Operations, Standard Operating Procedures, Section 3 “Serviceability Inspections”*.

Aerodrome Reporting Officers carry out routine runway serviceability inspections daily at the following approximate times:

RUNWAY INSPECTION TIMES			
TIME	INSPECTION	RESOURCE	METHOD
FIRST LIGHT	Full Inspection	1 X Aerodrome Reporting Officer	1 Vehicle starting against the direction of travel of aircraft, and returning on the opposite side of the RWY.
MIDDAY	High Speed	1 X Aerodrome Reporting Officer	1 Vehicle starting against the direction of travel of aircraft and travelling down the runway centerline, vacate at the end.
PRE LAST LIGHT	High Speed	1 X Aerodrome Reporting Officer	1 Vehicle starting against the direction of travel of aircraft and travelling down the runway centerline, vacate at the end.
MIDNIGHT	Full Inspection	1 X Aerodrome Reporting Officer	1 Vehicle starting against the direction of travel of aircraft, and travelling down the runway, vacate at the end.
0300 HRS	High Speed	1 X Aerodrome Reporting Officer	1 Vehicle starting against the direction of travel of aircraft, and travelling down the runway, vacate at the end.
NOTE: ALL RWY INSPECTIONS SHALL BE CONDUCTED WITH 2 X Aerodrome Reporting Officers IF AVAILABLE			

Figure 7 Runway Inspection Times

2.6.6 Communicating with Air Traffic Control

The duty Aerodrome Reporting Officer requires a clearance from ATC before entering the runway to carry out a serviceability inspection and maintains communications with ATC at all times using the tower (air-ground) frequency until he/she has vacated the manoeuvring area.

2.6.7 Serviceability Inspection Records

The Airside Operations Team Leaders/Officers complete daily duties within Tracker Airside which populates a record of their serviceability inspections. A representation of the basic duties of the Aerodrome Reporting Officers, and the allocation of them to specific operations vehicles are as follows:

2.6.7.1 OPS 20 - Movement area – daily duties:

- 01R/19L RWY Routine Inspections
- 14/32 RWY Routine Inspections
- 01R/19L TWYS Routine Inspections
- 14/32 TWYS Routine Inspections
- H, M TWYS Routine Inspections
- 01R/19L & 14/32 RWY Specific Inspections

OPS 20 Routine Checks	OPS 20 Response	OPS 20 Scheduled and Adhoc	OPS 20 Preparation
RWY Inspections	Spill Clean-up Oil, Fuel, Sewage	Other Duties as required	Firearms Maintenance
PAPI & RGL & OLS Check	AEP Duties	Security Checks	Vehicle serviceability
Gable Markers and WI Check	Low Visibility (LVP)	Wildlife Duties	Vehicle Stocks
Aprons LPB, GA Check	FOD reports		Vehicle cleanliness (weekly)
Aprons DTB, ITB Check			Administration
Nightly Lights Check			
Full Lights Check (Saturday)			

2.6.7.2 OPS 21 - Movement area – daily duties:

- Wildlife hazard management
- 14/32 Routine Wildlife Inspections

OPS 21 Routine Checks	OPS 21 Response	OPS 21 Scheduled and Adhoc	OPS 21 Preparation
14/32 RWY Inspections	Wildlife RWY Inspection	Other Duties as required	Firearms Maintenance
Wildlife Counts	Wildlife FOD	Security Checks	Vehicle serviceability
Wildlife Patrol	AEP Duties		Vehicle Stocks
	Low Visibility (LVP)		Vehicle cleanliness (weekly)
			Administration

2.6.7.3 OPS 22 - Movement area – daily duties:

- Airside Works Escort

OPS 22 Routine Checks	OPS 22 Response	OPS 22 Scheduled and Adhoc	OPS 22 Preparation
Airside Works & Escorts	Spill Clean-up Oil, Fuel, Sewage	Airside Escorts	Firearms Maintenance
Aircraft Parking Log	AEP Duties	Other Duties as required	Vehicle serviceability
OLS Check from Tower (Saturday Night)	Low Visibility (LVP)	Security Checks	Vehicle Stocks
	Wildlife Duties	Wildlife Duties	Vehicle cleanliness (weekly)
			Administration

2.6.7.4 OPS 23 - Movement area – daily duties:

OPS 23 Routine Checks	OPS 23 Response	OPS 23 Scheduled and Adhoc	OPS 23 Preparation
Airside Works & Escorts	Spill Clean-up Oil, Fuel, Sewage	Airside Escorts	Firearms Maintenance
	AEP Duties	Other Duties as required	Vehicle serviceability
	Low Visibility (LVP)	Security Checks	Vehicle Stocks
	Wildlife Duties	Wildlife Duties	Vehicle cleanliness (weekly)
			Administration

2.6.7.5 OPS 24 – Team Leader

OPS 24 Team Leader Routine	OPS 24 Team Leader Response	OPS 24 Team Leader Scheduled and Adhoc	OPS 24 Team Leader Preparation
Allocate Duties	Overtime Call Out	Airside Escorts	Firearms Maintenance
Communicate NOTAMS, and NTO's	AEP Duties	Other Duties as required	Record & Restock Ammunition
Communicate Works and Works Permits		Security Checks	Vehicle serviceability
Sign In-Out Firearms and Ammunition		Wildlife Duties	Vehicle Stocks
AOC Restock		Airside Patrols	Vehicle cleanliness (weekly)
Administration			Administration

2.6.7.6 OPS 25 - Movement area – daily duties:

OPS 25 Routine Checks	OPS 25 Response	OPS 25 Scheduled and Adhoc	OPS 25 Preparation
Airside Works & Escorts	Spill Clean-up Oil, Fuel, Sewage	Airside Escorts	Firearms Maintenance
	AEP Duties	Other Duties as required	Vehicle serviceability
	Low Visibility (LVP)	Security Checks	Vehicle Stocks
	Wildlife Duties	Wildlife Duties	Vehicle cleanliness (weekly)
			Administration

2.6.8 Reporting Inspection Results

If the Aerodrome Reporting Officer detects an anomaly or unserviceability on the movement area and:

- ensures that any unserviceability (or unsafe situation) is correctly marked in accordance with *CASR MOS Par 139 Section 8.9*;
- reports the unserviceability, or situation that may affect the safety of aircraft operations, in accordance with the procedures detailed in *Part 2, Section 4* of the Manual;
- if necessary, assesses the condition/facility in consultation with the Airside Operations Manager and/or the Airport Facilities Manager who will arrange a technical inspection if necessary;
- reviews the status of repairs at the nominated time; and
- advises ATC of the reinstatement of the facility or the expected duration of the continued unserviceability.

2.6.9 Roles and Responsibilities

The duty Aerodrome Reporting Officers conducts daily serviceability inspections.

The Airside Standards Manager or delegate is responsible for ensuring the relevant standards for aerodrome facilities are met, negotiating where necessary with CASA and Airservices on issues of exemptions, revised standards and temporary non-compliance.

The Airside Operations Manager is responsible for the day to day monitoring and maintenance of aviation standards and airport serviceability, and ensures that sufficient inspections of airport facilities, the OLS and obstacle lights/hazard beacons are carried out to confirm this.

The telephone numbers of BAC staff nominated in this procedure can be found on the Telephone Contact List at the front of the Manual.

References

CASRs

139.125 Reporting officer

139.220 Aerodrome serviceability inspections

139.225 When aerodrome serviceability inspections must be conducted

MOS Part 139 – Aerodromes

Chapter 8.3 Runway Markings

Chapter 8.9 Markings of Unserviceable and Work Areas

Chapter 9.18 Lighting Associated with Closed and Unserviceable Areas

Chapter 9.20 Monitoring, Maintenance and Serviceability of Aerodrome Lighting

Chapter 10.2 Inspecting and Reporting Aerodrome Serviceability

Part 2

Section 7 - Aerodrome Technical Inspections

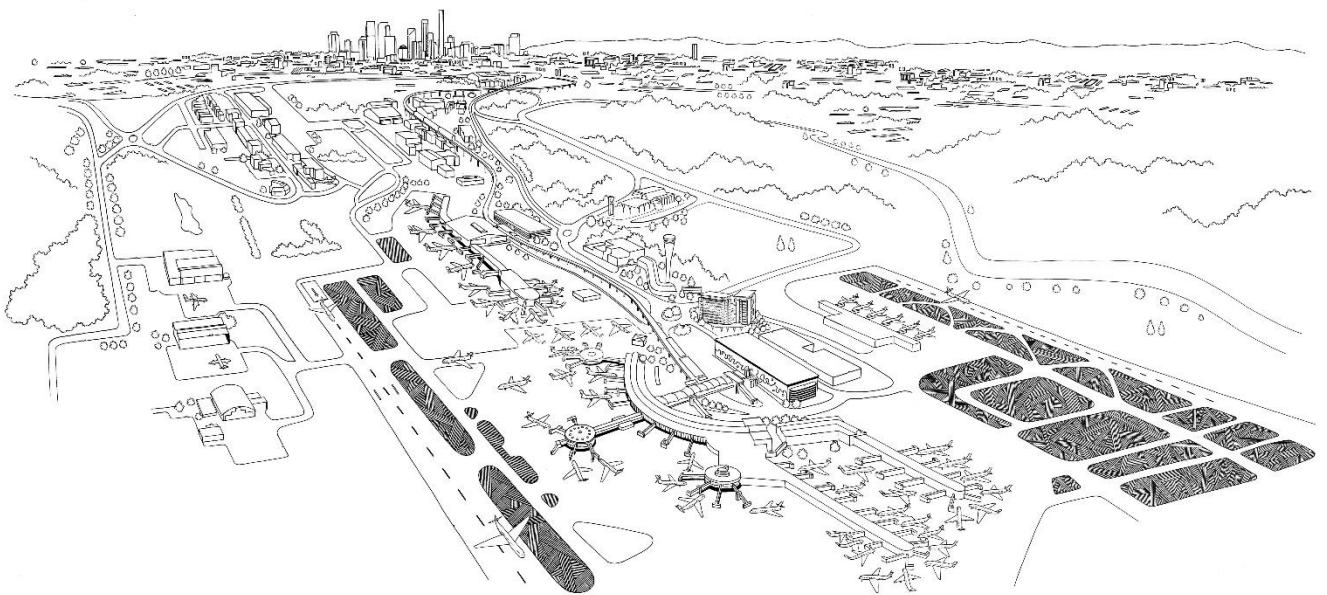

2.7 Aerodrome Technical Inspections

To meet the requirements of CASR 139.240 only appropriately qualified persons will carry out Technical Inspections.

CASR 139.235 allows for the conduct of parts of the technical inspection to be at different times, however each part of the technical inspection will be completed at intervals of not more than twelve months.

Technical Inspections will be carried out if the need is identified by a serviceability inspection.

(i) The items that need to be technically inspected and when the inspections are to be carried out.

CASR 139.235 states that the inspection must include the following:

- (a) an instrument survey of the approach, take-off and transitional surfaces including GPS-NPA protection;*
- (b) an inspection and testing of the aerodrome lighting and electrical reticulation systems, including the visual approach slope indicator;*
- (c) an electrical testing of any earthing points at the aerodrome;*
- (d) an inspection and assessment of the movement area pavements and drainage;*
- (e) an inspection of signs on the movement area;*
- (f) an inspection of facilities at the aerodrome used for any of the following:*
 - (i) aerodrome emergencies;*
 - (ii) the handling of hazardous materials;*
 - (iii) bird and animal hazard management;*
 - (iv) stand-by and emergency aerodrome lighting;*
- (g) an inspection of airside vehicle control arrangements (if any);*
- (h) a check of the currency and accuracy of:*
 - (i) aerodrome information published in AIP; and*
 - (ii) aerodrome operating procedures specified in the aerodrome manual for the aerodrome.*

The Technical Inspection is intended to ensure that any circumstances or a condition that could make a facility unsafe for aircraft operations is detected

The inspection regime includes either an approach/take-off OLS survey or a Type A survey on an alternate annual basis. The different types of inspections involved results in the inspections being undertaken by a range of different inspectors at different intervals.

2.7.1 Roles and Responsibilities

A BAC surveyor carries out the OLS survey and the Type A survey.

Members of the BAC Civil and Maintenance Group (under the guidance of the Civil & Airport Lighting Asset Maintenance Manager) conduct the inspections of movement area pavements and drainage.

The BAC Airport Lighting team carries out all the electrical inspections.

The Airside Operations Manager or delegate carries out or organises to have carried out the remaining inspections.

Technical inspections are also carried out if the need is identified by a serviceability inspection.

2.7.2 The arrangements for technically qualified people to carry out the technical inspections

The Airside Operations Manager or delegate utilises the BAC service request program 'Maximo' to schedule the inspections and utilises in-house expertise and/or where necessary engages consultants/contractors to carry out the inspections. Maximo is not used to engage consultants for the Annual Technical Inspection.

He/she, or delegate ensures that all inspectors have suitable experience and are qualified in terms of *CASR 139.24*.

He/she, or delegate records details of their credentials in the file containing the technical inspection report(s).

2.7.3 Technical Inspections records

The Airside Operations Manager, or delegate retains a copy of the completed Technical Inspection report.

He/she, or delegate files a copy of the Technical Inspection report. Copies of the reports and records of follow up action are kept on file by the Airside Operations Manager, or delegate for at least 3 years in accordance with the requirements of *CASR 139.235 (4) a (ii)*.

If the primary inspection indicates that a permanent or temporary change to published information is required, the Airside Operations Manager, or delegate reports the change in accordance with the procedures detailed in *Part 2, Section 4* (Aerodrome Reporting) of the Manual.

References

CASRs

139.230 Aerodrome technical inspections

139.235 When aerodrome technical inspections must be conducted etc.

139.240 Who may conduct aerodrome technical inspections?

MOS Part 139 – Aerodromes

Section 10.18 Aerodrome Technical Inspections

Part 2

Section 8 - Aerodrome Works Safety

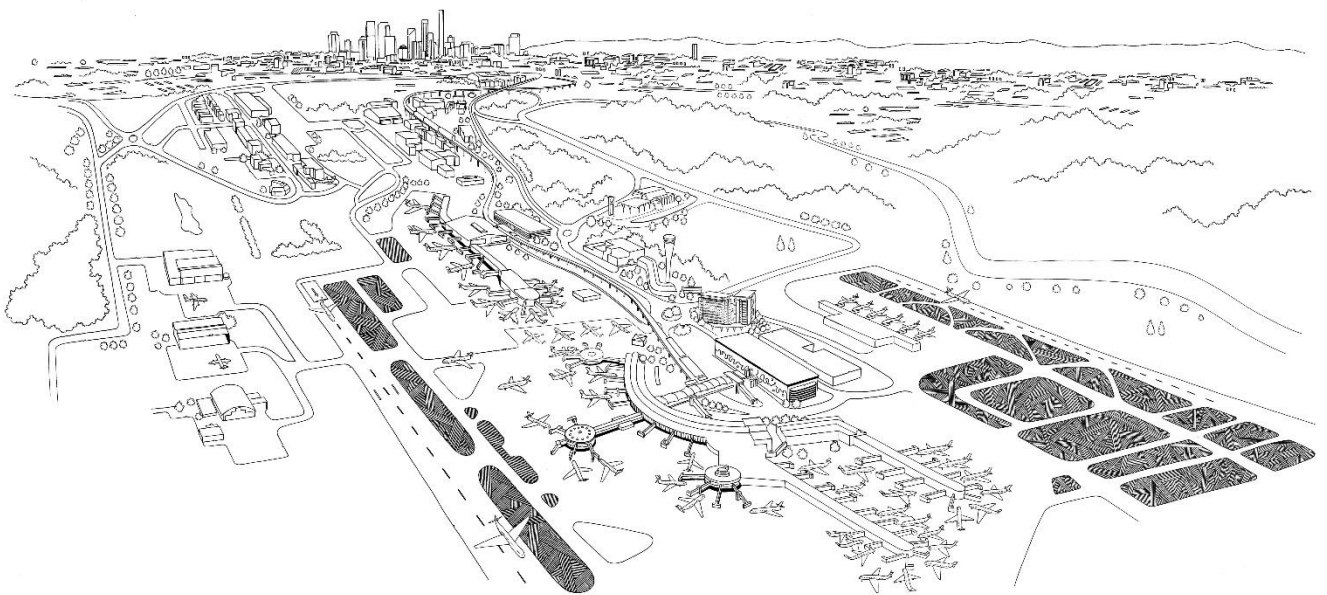

2.8 Aerodrome Works Safety

To meet the requirements of Appendix 1 to subparagraph CASR 139.095(a) (ii) this section deals with particulars of the procedures for planning and safely carrying out aerodrome works, including works that may have to be carried out at short notice as follows:

Aerodrome Works means: Construction or maintenance works carried out at an aerodrome, on or adjacent to the movement area, that may create obstacles or restrict the normal take-off and landing of aircraft.

Installation of new facilities and maintenance of existing facilities will be carried in accord with the requirements of MOS 139.

All aerodrome works will be carried out in accordance with MOS 139.

- **NOTAMs will be issued not less than 48 hours before commencement of aerodrome works under an MOWP or 24 hours for time limited works.**
- **Time limited works will not be carried out at night or when visibility is less than 5km.**
- **Duties of the Works Safety Officer will be in accord with MOS 139 Chapter 10 Section 10.12.**

Works within runway strips will be conducted in accord with the requirements in MOS 139 Chapter 10 Sub-section 10.10.12.

Arrangements for ensuring compliance with the MOS requirements relating to the period of notice for works.

Arrangements for providing and setting out visual aids for works.

Suitable quantities of visual aids available

The MOWP drawing to depict chainages; for runway, equipment limit line [witches hats], runway end [red and white u/s cones] and displaced threshold.

Arrangements for providing a trained works safety officer for aerodrome works.

- (i) *The preparation of a method-of-working plan identifying areas of the aerodrome affected during each stage of the work and steps taken to ensure safety standards are met;*
 - *Identify the person/position responsible for writing the MOWP.*
- (ii) *The distribution list for the method-of-working plan;*
- (iii) *The arrangements for telling aircraft operators and other aerodrome users of the method-of-working plan and the telephone numbers for contacting those operators and users during and after working hours;*
- (iv) *The arrangements for communicating with air traffic control and aircraft during the carrying out of the works;*
- (v) *The arrangements for carrying out time-limited works;*
 - *Include procedure for ensuring works safety officer coverage.*
- (vi) *Arrangements for ensuring that any works do not create a hazard to aircraft or confusion to pilots.*
- (vii) *The titles and roles of the persons who are responsible for planning and carrying out aerodrome works. The telephone numbers for contacting these persons must be included in the master contact list.*

2.8.1 Method of Working Plan

The preparation of a method-of-working plan identifying areas of the aerodrome affected during each stage of the work and steps taken to ensure safety standards are met.

The MOWP document provides formal and timely advice to the aviation industry of airport works. In particular, it advises of restrictions placed on aircraft operations and the works organiser as a consequence of the works. A MOWP is prepared for works that will have a major operational impact, or cause disturbance to operations over an extended period.

A MOWP is not required for temporary taxiway closures if an alternative taxiway route is available, or for works on aprons which have no significant impact on aircraft operations

2.8.2 Works planning

Airport works on the manoeuvring area are carried out either as:

- “time limited works”; or
- while the aerodrome is closed to aircraft operations; or
- Under the provisions of a method of working plan (MOWP).

Except in an emergency or highly abnormal circumstance it is impractical to close Brisbane Airport to aircraft operations.

2.8.3 Stakeholder Consultation

In preparing a MOWP, BAC consults with affected stakeholders and other interested parties in relation to:

- location and estimated time of commencement of work;
- extent of work, proposed stages and amended declared distances (if any);
- proposed operational restrictions, draft NOTAM, duration of each stage; and
- contact details for the Project Manager.

The agreed works restrictions are set out in the contract.

2.8.4 Format

The MOWP format is as specified MOS Part 139, Section 10.11. Each MOWP is signed as approved by the General Manager Operations, or delegate. The Project Manager arranges the necessary approvals and signatures. The MOWP drawing will depict, as appropriate, chainages for the runway, works limit area, runway end and displaced threshold (if any).

2.8.5 Amendments

A MOWP amendment is issued by BAC if:

- the estimated time of commencement or completion varies by more than ten (10) calendar days; or
- information in the original issue of the MOWP requires updating or amendment.

2.8.6 Notification

If works will cause major dislocation of operations and/or interruption to services the final draft is completed and the airlines notified at least five (5) weeks before works commence. This allows for approvals, production and distribution to be completed three (3) weeks prior to commencement.

The MOWP is distributed electronically. This list includes the Airlines and fixed base operators at Brisbane Airport as required by CASA. Approved variations to the MOWP are notified in the same manner, by written amendment approved



by the General Manager Operations, or delegate. CASA is advised in writing when projects are complete so that check lists of active MOWPs can be kept current.

For planned works that require a MOWP, the General Manager Operations, or delegate may decide to issue an Aeronautical Information Publication (AIP) Supplement.

Because these works have either a major or extended impact there is a need to fully notify the aviation industry. He/she will take account of the AIP amendment cycle in planning such works, as this may require 12 weeks advance notice to Aeronautical Information Services.

NOTAM are issued at least 48 hours before the commencement of works.

2.8.7 Permit to commence work

In addition to their air safety implications, some airport works may also cause potential disruption to the supply of essential services. In planning these works, the General Manager Operations, or delegate issues a Works Approval detailing the precautions necessary to ensure continuity of supply.

All work on airport (other than work undertaken by BAC staff) requires a Works Approval. Where the work is of a specific nature (i.e. working at heights, confined spaces or with HV electricity) a PTCW is required.

2.8.8 Unscheduled works

Airport works caused by unforeseen circumstances do not require a MOWP because it is impractical to prepare one in the time available. In such cases a NOTAM giving the date/time for commencement of the work is issued with as much advance notice as possible, preferably 48 hours. The Airside Standards Manager or delegate normally acts as the Project Manager for unscheduled works.

2.8.9 MOWP Distribution

The MOWP is distributed electronically and the email distribution list (as required under CASR 139.095 (a) (ii) - Appendix 1(h) (ii & iii)) is maintained and kept by the Airside Standards Manager (ASM). To update details and/or to be included in this distribution list, contact 07 3406 3169 or email. chris.young@bne.com.au

2.8.10 MOWP notification - aircraft operators and other aerodrome

The names and contact details of fixed base operators and aircraft operators who are to be notified of airport works are included in the MOWP email distribution list mentioned above.

2.8.11 MOWP notification – Air Traffic Control

For works on active runways, or runway strips, the Works Safety Officer (WSO) maintains communications with ATC at all times using the tower (air-ground) frequency.

2.8.12 Time Limited Works

Works, where personnel and equipment can be cleared from the works site within 10 minutes and will not disrupt normal aircraft operations, are permitted without a NOTAM needing to be issued. Time limited works in this category include activities such as;

- grass mowing,
- pavement sweeping,
- minor repairs to pavements,
- maintenance of markings/markers and
- lights, surveys and inspections.

2.8.13 Works on Runway Strips

Works on Runway Strips: MOS 139 Section 10.10.12 must be complied with fully.

Time limited works requiring more than 10 minutes, but no more than 30 minutes (longer if agreed locally by ATC), are advised by NOTAM which states the nature of the unserviceability, and the length of time required to terminate work and restore the works area to normal safety standards.

NOTAM are issued at least 24 hours prior to the proposed work, to minimise disruption to aircraft flight planning. Significant works such as the installation of MAGS have been possible under this provision.

Time limited works may be carried out at night or when visibility is less than 5 km provided ATC is operational. (MOS 10.10.4.2). ATC may suspended works during Low Visibility conditions.

2.8.14 Aerodrome Reporting Officer and WSO

In most cases the Aerodrome Reporting Officer will be assigned by the duty Airside Operations Team Leader and will perform the functions of a Works Safety Officer (WSO) or a contracted WSO will be resourced to facilitate the works as required Aerodrome Reporting Officer / WSO are nominated to perform the statutory role of the WSO and the specific functions of a WSO are detailed in the *MOS Part 139, Section 10.12*.

During periods of alert, low visibility or activation of the *Airport Emergency Plan*, the Aerodrome Reporting Officer / WSO may direct works parties to vacate the site/airside. Works parties must comply with these directions.

The Aerodrome Reporting Officer / WSO does not allow works to commence unless suitable equipment and resources are available to reinstate the works area, in accordance with the MOWP and pre-start toolbox meeting.

On completion of works the Aerodrome Reporting Officer / WSO ensures that the works area is fully cleaned up and reinstated to normal safety standards. In particular, the Aerodrome Reporting Officer / WSO ensures any longitudinal and transverse discontinuities in a pavement surface are within tolerances set in the MOS and that runway markings, taxiway centreline and taxi-holding position markings have not been obscured by spoil or works residue, or have been fully reinstated.

2.8.15 Roles and Responsibilities

The General Manager Operations or delegate has overall responsibility for establishing procedures for the safe conduct of airport works.

As required by the CASA, the General Manager Assets or delegate nominates a Project Manager for each work task.

The Airside Operations Manager or delegate is responsible for the day to day oversight of safety aspects of all airport works. He/she nominates an appropriately trained and experienced Aerodrome Reporting Officer / WSO for each airport works.

The Project Manager and Airside Standards Manager or delegate nominated for airport works is responsible for:

- detailed planning and co-ordination of the work;
- assessing possible disruptions to aircraft operations;
- liaison with ATC, CASA, works organisations and aircraft operators on Brisbane Airport;
- determining variations to the movement area dimensions published in AIP-ERSA;
- preparation, promulgation and amendment of Method of Working Plans (MOWPs);
- issuing any associated NOTAM;
- determining that sufficient quantities of visual aids are available;



- ensuring that a Permit to Commence Work (PTCW) is raised for each major work; and
- briefing the Aerodrome Reporting Officer.

The Aerodrome Reporting Officer nominated for an airport work is responsible for:

- correct placement and removal of temporary markings and lighting;
- briefing works organisations on general safety matters, and in particular the danger of entry into serviceable movement areas;
- safe handover to the next shift or replacement Officer on duty at works;
- remaining on site during the works; and
- giving direction to any person associated with the work, to ensure the safety of aircraft operations.

The telephone numbers of BAC staff nominated in this procedure can be found on the telephone contact list at the front of the manual.

References

CASRs

- 139.130 *Aerodrome Reporting Officer for aerodrome works other than time-limited works*
- 139.135 *Aerodrome Reporting Officer for time-limited works*
- 139.170 *Aerodrome markings*
- 139.245 *Planning and execution of aerodrome works*

MOS Part 139 – Aerodromes

- Section 10.10 *Aerodrome Works Safety*
- Section 10.11 *Method of Working Plans*
- Section 10.12 *Functions of an Aerodrome Reporting Officer*

Part 2

Section 9 - Aircraft Parking Control

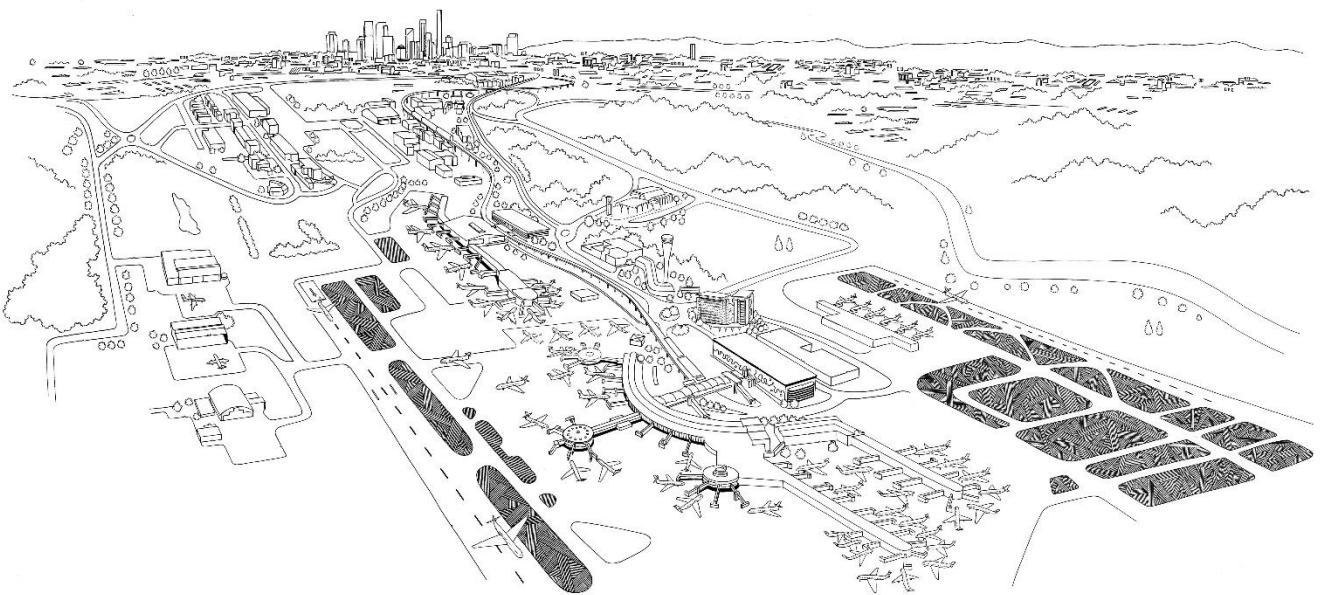

2.9 Aircraft Parking Control

To meet the requirements of Appendix 1 to CASR subparagraph 139.095(a) (ii) this section deals with particulars of the procedures for aircraft parking control, if established, including the following.

- (i) Particulars of the procedures for aircraft parking control, if established, including details of the following:*
- (ii) The arrangements between air traffic control and apron management;*
- (iii) The arrangements for allocating aircraft parking positions;*
- (iv) The arrangements for initiating engine start and ensuring clearances for aircraft push-back;*
- (v) An inventory and description of the activation and deactivation of any visual docking guidance system used at the aerodrome;*
- (vi) The marshalling service;*
- (vii) The leader (van) service or follow-me service;*
- (ii) The names, telephone numbers and roles of the persons responsible for planning and implementing aircraft parking control.*

2.9.1 Apron management

There is no separate apron management function at Brisbane Airport and accordingly, there are no arrangements between ATC and Apron Management.

2.9.2 Allocating Parking Positions

Parking space for aircraft cannot always be assured. Controls are required to ensure the orderly and safe parking of aircraft, with priority given to scheduled regular public transport operations.

Policies and procedures have been developed by BAC in relation to:

- movement of the aircraft on an aircraft stand;
- allocation of particular aircraft bays;
- time limitations applying to the use of aircraft stands; and
- removal of aircraft when a time limitation has been exceeded or in an emergency.

2.9.3 Designated Parking Areas

BAC is responsible for aircraft parking control at all Non-Licensed aprons (i.e.-excludes areas licensed to Qantas and Virgin Australia on the DTB Apron) which includes, but not limited to:

- GA Apron (includes bays G2-G23 inclusive);
- DTB Apron (includes bays 25-38, 50-64, 100-111 inclusive);
- ITB Apron; and the
- LPB Apron.

The extensions of taxiway Lima (including "Lima Loop"), Papa, Echo and taxiway Foxtrot-3 (and other operational areas as determined by BAC) are available for itinerant and layover aircraft parking as directed by BAC. These aircraft parking areas are common user and controlled by BAC. The procedures in this section deal only with aircraft parking in the



abovementioned areas. Apron Usability Charts detailing the designated aircraft parking areas can be obtained by contacting the BAC Airside Operations Centre (AOC).

2.9.4 Common User - Bay Allocation Guidelines

BAC Terminal Operations (07 3406 3171) administers the policies and procedures established for allocation and use of the designated aircraft bays.

Aircraft bay allocation is managed by the DTM and/or Control Coordinator utilising Airport resource management software system, Airport 20/20. Bay allocation rules are built into the system to ensure aircraft allocation is consistent with all information and any operating restrictions as reflected in the *Apron Usability Charts* or published in *AIP-ERSA*.

It is the responsibility of each airline/handling agent to ensure that bays are left clear of equipment after each aircraft movement. All items of Ground Service Equipment (GSE) must be stored in the common-user GSE areas or the licensed area.

2.9.5 Apron Servicing Licence Agreement

It is the responsibility for all companies that undertake aircraft servicing activities to ensure they have a current licence with BAC and comply with the conditions of the licence agreement. Including those conditions regarding operation of Ground Service Equipment (GSE).

ADA's and AUA's will not be issued to operators without a current *Apron Servicing Licence Agreement* in place. Operators should refer and comply with the relevant sections of the *Aviation Services and Charges Agreement* and the *Terminal Operations Procedures* documents as required.

2.9.6 Other Parking Arrangements

BAC requires all aircraft to be parked only in designated areas as controlled by BAC and to comply with the rules developed for allocation and use of these areas. Pilots and operators are to ensure that any aircraft parking, servicing or manoeuvring operation complies with CASA requirements for clearance and aircraft parking standards, including CAO20.9.

2.9.7 Freight Operations

Airside Operations Standard Operating Procedures *Section 4 Escorts and Section 6 Wildlife Management* or, *Part 2, Section 19 Livestock Transfers* of the Manual, details procedures for the handling of livestock at Brisbane Airport.

2.9.8 Aircraft Clearances

All aircraft departing Brisbane Airport require engine start and push back clearances from ATC. Pilots contact Brisbane Ground on 121.7 MHz.

2.9.9 DTB Visual Docking Guidance

The apron visual guidance docking system at the Domestic Terminal Building (DTB) aerobridges includes:

- aerobridge retracted indicator light unit;
- position identification unit (bay marker);
- center-line guidance unit or azimuth display; and
- stopping indicator unit or side marker light.

The aerobridge retracted indicator light unit consists of two lights (1 green, 1 red) to indicate to the pilot the state of the aerobridge retraction. The green light only operates when the aerobridge is fully retracted, thus indicating safety in proceeding to the docking position. At all other times the red light is illuminated, indicating to the pilot not to proceed with parking.

2.9.10 Domestic Terminal Apron Parking Position

DOMESTIC APRON						
STAND	CO-ORDINATES		ELEV (FT)	CAPACITY	HYDRANT FUEL	DOCKING SYSTEM
1A	272252.735	1530721.17E	12	DH8D	NIL	MARSHALLER
1B	272252.185	1530719.88E	12	DH8D	NIL	MARSHALLER
1C	272251.605	1530718.54E	12	DH8D	NIL	MARSHALLER
1D	272251.705	1530716.97E	12	DH8D	NIL	MARSHALLER
3	272252.595	1530715.59E	12	DH8D	NIL	MARSHALLER
4	272253.995	1530716.46E	12	DH8D	NIL	MARSHALLER
5	272257.835	1530715.35E	12	DH8D	NIL	MARSHALLER
6	272258.375	1530716.79E	12	DH8D	NIL	MARSHALLER
15	272254.045	1530725.75E	11	B739	NIL	MARSHALLER
15A	272253.375	1530724.51E	10	B739	NIL	MARSHALLER
15B	272252.575	1530723.18E	10	B739	NIL	MARSHALLER
15C	272253.615	1530725.77E	12	B789	NIL	MARSHALLER
16	272257.115	1530718.42E	12	B739	JET A-1	MARSHALLER
17	272256.935	1530719.88E	12	B739	JET A-1	SAFEGATE
18	272257.485	1530721.06E	12	B739	JET A-1	SAFEGATE
19	272258.495	1530721.77E	12	B739	JET A-1	SAFEGATE
20	272259.695	1530721.85E	12	A333	JET A-1	SAFEGATE
21	272300.905	1530721.09E	12	B739	JET A-1	SAFEGATE
21B	272301.095	1530722.74E	12	B739	NIL	SAFEGATE
22	272301.695	1530716.65E	12	B739	JET A-1	SAFEGATE
22B	272301.285	1530718.96E	12	B739	NIL	SAFEGATE
23	272303.515	1530716.81E	12	B739	JET A-1	SAFEGATE
24	272304.825	1530716.29E	12	B744	JET A-1	SAFEGATE
25	272307.095	1530716.15E	12	B739	JET A-1	SAFEGATE
25B	272307.855	1530717.95E	12	B739	NIL	MARSHALLER
26	272308.205	1530720.22E	12	B739	JET A-1	MARSHALLER
26A	272308.355	1530720.22E	12	B744	JET A-1	MARSHALLER
27	272308.755	1530721.65E	12	B739	JET A-1	MARSHALLER
28	272309.925	1530720.94E	12	B739	JET A-1	MARSHALLER
29	272311.095	1530720.28E	12	B739	JET A-1	MARSHALLER
30	272312.255	1530719.71E	12	B739	JET A-1	MARSHALLER
31	272313.465	1530718.93E	12	A320	JET A-1	MARSHALLER
32	272312.605	1530717.82E	12	B739	JET A-1	MARSHALLER
38	272309.985	1530714.47E	12	B739	JET A-1	SAFEGATE
38B	272311.275	1530716.21E	12	B739	NIL	MARSHALLER
39	272311.385	1530713.17E	12	B739	JET A-1	Centreline + Sidemarker
40	272312.625	1530711.55E	12	A332	JET A-1	SAFEGATE
40A	272312.535	1530712.10E	12	B739	JET A-1	SAFEGATE
40B	272313.425	1530711.58E	12	B739	JET A-1	SAFEGATE
41	272313.505	153070988E	12	B739	JET A-1	Centreline + Sidemarker
41B	272315.825	1530710.71E	12	B739	NIL	MARSHALLER
43	272316.995	1530711.79E	12	B739	JET A-1	Centreline + Sidemarker
44	272318.085	1530711.41E	12	A332	JET A-1	SAFEGATE
44A	272318.195	1530711.77E	12	B739	JET A-1	SAFEGATE
44B	272319.435	1530711.57E	12	B739	JET A-1	SAFEGATE
45A	272319.695	1530710.42E	12	B739	JET A-1	SAFEGATE
46	272319.225	1530709.10E	12	B739	JET A-1	Centreline + Sidemarker
47	272318.805	1530707.86E	12	B739	JET A-1	SAFEGATE
48	272317.975	1530706.92E	12	B739	JET A-1	SAFEGATE
49	272316.455	1530707.28E	11	F100	NIL	MARSHALLER
50	272314.545	1530706.80E	11	F100	NIL	MARSHALLER
50A	272314.485	1530706.22E	11	ATR72	NIL	MARSHALLER
53	272319.265	1530702.43E	12	B739	NIL	MARSHALLER
54	272320.485	1530701.71E	12	B739	NIL	MARSHALLER
55	272321.715	1530701.01E	12	B739	NIL	MARSHALLER
56	272322.945	1530700.31E	12	B739	NIL	MARSHALLER
57	272324.175	1530659.60E	12	B739	NIL	MARSHALLER
60	272324.445	1530704.97E	12	B739	NIL	MARSHALLER
61	272325.075	1530706.35E	12	B739	NIL	MARSHALLER
62	272325.695	1530707.73E	12	B739	NIL	MARSHALLER
63	272326.335	1530709.10E	12	B739	NIL	MARSHALLER
64	272326.955	1530710.48E	12	B739	NIL	MARSHALLER
100	272252.935	1530727.71E	12	B739	NIL	MARSHALLER
101	272251.605	1530728.48E	12	B739	NIL	MARSHALLER
102	272250.275	1530729.24E	12	B739	NIL	MARSHALLER
103	272248.935	1530729.99E	12	B739	NIL	MARSHALLER
108	272249.505	1530731.23E	12	B739	NIL	MARSHALLER
109	272250.835	1530730.46E	12	B739	NIL	MARSHALLER
110	272252.155	1530729.69E	12	B739	NIL	MARSHALLER
111	272253.495	1530728.93E	12	B739	NIL	MARSHALLER

Figure 8 Domestic Terminal Apron Parking Position

2.9.11 Position Identification Unit (Bay Marker)

The position identification unit consists of large white numerals on black background. At night, the numerals are outlined with green neon lights controlled by a photo-electric cell.

2.9.12 Nose-in Guidance System (NIG)

The centre-line guidance and stopping indicator units combined are known as a nose-in guidance system (NIG). The centreline guidance unit or azimuth display produces two vertical beams of coloured light, both being green when on course. Deviation from the centreline provides a red signal on the side of deviation.

2.9.13 Stopping Indicator

The stopping indicator unit or side marker light provides an arrow shaped green light which decreases in size as the aircraft approaches its correct position. Two vertical bars of white light indicate the correct stopping position, while aircraft overshoot is indicated by a single vertical bar of red light.

The docking system is installed on parking bays 17, 18, 20-23, 25, 38, 40, 41, 43, 44, 45 and 46. Bay 24 at the DTB is used by Qantas and has had a dual tunnel aerobridge installed with an alternate docking system – Safegate laser system.

This system provides an incoming aircraft with azimuth guidance and distance to stop data in the one unit. The system displays closing rate as a thermometer type display controlled by an electronic measuring unit mounted adjacent the APIS display unit. The system is also capable of displaying additional data such as flight number.

2.9.14 ITB Apron Visual Docking Guidance

The docking system at the ITB aerobridges includes:

- aerobridge retracted indicator light unit;
- position identification unit (bay marker); and
- combined center-line guidance unit and azimuth display, and stopping indicator.

There is one type of visual docking guidance system used on the ITB Apron, the Safegate laser system. This system provides both the stopping indicator and azimuth guidance in one unit at the front of each bay so that the pilot can observe both azimuth and stop signals without turning his/her head.

2.9.15 International Terminal Apron Parking Positions

INTERNATIONAL APRON						
STAND	CO-ORDINATES		ELEV (FT)	CAPACITY	HYDRANT FUEL	DOCKING SYSTEM
69	272357.545	1530644.65E	15	B744/B773	JET A-1	MARSHALLER
69A	272357.335	1530644.07E	15	B739/A321	JET A-1	MARSHALLER
70	272355.325	1530645.78E	15	B744/B773	JET A-1	MARSHALLER
70A	272355.715	1530645.69E	15	B739/A321	JET A-1	MARSHALLER
70B	272354.635	1530645.16E	15	B739/A321	JET A-1	MARSHALLER
71	272353.755	1530646.63E	15	A388	JET A-1	MARSHALLER
71A	272353.465	1530646.09E	15	B739/A321	JET A-1	MARSHALLER
71B	272352.635	1530647.15E	15	B739/A321	JET A-1	MARSHALLER
72	272355.075	1530649.14E	15	A388	JET A-1	MARSHALLER
72A	272354.695	1530649.27E	15	B739/A321	JET A-1	MARSHALLER
72B	272355.105	1530650.78E	15	B739/A321	JET A-1	MARSHALLER
73	272356.465	1530650.79E	15	A388	JET A-1	SAFEGATE
73A	272356.335	1530651.02E	15	B739/A321	JET A-1	SAFEGATE
73B	272357.565	1530651.60E	15	B739/A321	JET A-1	SAFEGATE
74	272358.915	1530649.60E	15	A388	JET A-1	SAFEGATE
74A	272358.695	1530649.74E	15	B739/A321	JET A-1	SAFEGATE
74B	272359.955	1530650.30E	15	B739/A321	JET A-1	SAFEGATE
75	272401.485	1530648.03E	15	A388	JET A-1	SAFEGATE
75A	272401.275	1530648.11E	15	B739/A321	JET A-1	SAFEGATE
75B	272402.625	1530648.78E	15	B739/A321	JET A-1	SAFEGATE
76	272403.555	1530646.10E	15	A388	JET A-1	SAFEGATE
76A	272403.415	1530646.40E	15	B739/A321	JET A-1	SAFEGATE
76B	272404.665	1530646.53E	15	B739/A321	JET A-1	SAFEGATE
77	272405.695	1530643.66E	15	B744/B773	JET A-1	SAFEGATE
78	272407.865	1530642.40E	15	B744/B773	JET A-1	SAFEGATE
79	272410.025	1530641.16E	15	B744/B773	JET A-1	SAFEGATE
80	272412.205	1530639.92E	15	B744/B773	JET A-1	SAFEGATE
81	272414.385	1530638.70E	15	B744/B773	JET A-1	SAFEGATE
82	272416.535	1530637.43E	15	B744/B773	JET A-1	SAFEGATE
83	272418.465	1530636.21E	15	B744/B773	JET A-1	SAFEGATE
84	272419.945	1530634.62E	15	B744/B773	JET A-1	SAFEGATE
85	272421.175	1530632.43E	15	B744/B773	JET A-1	SAFEGATE
86	272422.425	1530630.09E	15	B744/B773	JET A-1	SAFEGATE
86B	272423.495	1530628.95E	15	B739/A321	JET A-1	MARSHALLER
87	272423.735	1530627.66E	15	B744/B773	JET A-1	MARSHALLER
87B	272423.915	1530627.31E	15	B753	JET A-1	MARSHALLER

Figure 9 International Terminal Apron Parking Positions

2.8.15.1 International apron aerobridge type and parking restrictions

The ITB Apron Usability Chart details the aerobridge types and any aircraft parking restrictions for each bay.

Note: AIP Australia contains additional descriptive and operating detail on all the visual docking systems at Brisbane Airport. Please refer relevant current Apron Usability Charts for information.

2.9.16 Marshalling Service

BAC in accordance with Civil Aviation Order CAO 20.3 does not provide a physical aircraft marshalling service. This is the responsibility of the aircraft operator.

At the request of the aircraft operator, duty Aerodrome Reporting Officers will provide a follow me service.

The telephone numbers of BAC staff nominated in this procedure can be found on the Telephone Contact List at the front of the Manual.

2.9.17 Changes and additions to apron stand layout

All required changes, additions and/or removal of aircraft parking guide lines on the designated parking areas and the extensions of Taxiways Lima and Papa are to be referred to the BAC Airside Standards Manager, or delegate.

He/she will co-ordinate design review, consultation with Airservices Australia, CASA and airlines of the implementation process. BAC maintains apron markings to a serviceable standard and provides a design, set-out and installation service for required changes to apron markings. Changes and additions to apron stand layout will be forwarded to contacts on the Apron Usability Distribution List.

2.9.18 Logistics Apron Parking Positions

LOGISTIC APRON						
STAND	CO-ORDINATES		ELEV (FT)	CAPACITY	HYDRANT FUEL	DOCKING SYSTEM
L1	272504.44S	1530603.29E	12	F100	NIL	NIL
L1A	272505.64S	1530601.77E	12	F100	NIL	NIL
L3A	272506.90S	1530600.58E	12	B747	NIL	NIL
L3B	272506.13S	1530559.30E	11	B737	NIL	NIL
L3	272507.10S	1530600.34E	12	B767	NIL	NIL
L4	272508.59S	1530558.60E	12	B747	NIL	NIL
L5	272510.29S	1530556.61E	13	B747	NIL	NIL
L6	272512.04S	1530554.55E	13	AN124	NIL	NIL
P1	272449.63S	1530550.44E	9	A320	NIL	NIL
P2	272451.03S	1530548.75E	9	A320	NIL	NIL
P3	272452.30S	1530547.23E	9	F100	NIL	NIL
P4	272451.75S	1530546.44E	9	A320	NIL	NIL
P4A	272450.74S	1530547.62E	9	A320	NIL	NIL
P4B	272449.73S	1530548.80E	9	A320	NIL	NIL
P4C	272448.72S	1530549.98E	9	A320	NIL	NIL
P5	272439.51S	1530615.81E	9	A320	NIL	NIL
P6	272440.76S	1530614.35E	9	A320	NIL	NIL
P7	272456.63S	1530553.01E	9	A320	NIL	NIL

Figure 10 Logistics Apron Parking Positions

BAC Terminal Operations (07 3406 3171) administers the policies and procedures established for allocation and use of the designated aircraft bays.

Aircraft bay allocation is managed by the DTM and/or Control Coordinator utilising Airport resource management software system, Airport 20/20. Bay allocation rules are built into the system to ensure aircraft allocation is consistent with all information and any operating restrictions as reflected in the Apron Usability Charts or published in AIP-ERSA.

2.9.19 General Aviation Apron Parking Positions

GENERAL AVIATION APRON						
STAND	CO-ORDINATES		ELEV (FT)	CAPACITY	HYDRANT FUEL	DOCKING SYSTEM
G2	272229.175	1530733.71E	12	ATR	NIL	NIL
G3	272228.195	1530734.27E	12	ATR	NIL	NIL
G4	272227.265	1530734.97E	12	F100	NIL	NIL
G5	272226.245	1530735.57E	12	F100	NIL	NIL
G6	272225.215	1530736.15E	13	F100	NIL	NIL
G7	272223.785	1530732.48E	13	Q300	NIL	NIL
G8	272223.245	1530731.34E	12	Q300	NIL	NIL
G9	272222.725	1530730.18E	12	Q300	NIL	NIL
G10	272222.205	1530729.03E	12	Q300	NIL	NIL
G11	272221.685	1530727.88E	12	Q300	NIL	NIL
G12	272223.625	1530726.10E	12	Q300	NIL	NIL
G13	272224.455	1530727.89E	12	Q300	NIL	NIL
G14	272225.285	1530730.31E	12	SF340	NIL	NIL
G15	272225.875	1530731.64E	12	SF340	NIL	NIL
G16	272225.765	1530730.87E	12	SF340	NIL	NIL
G17	272224.825	1530728.81E	12	SF340	NIL	NIL
G18	272224.015	1530727.03E	12	SF340	NIL	NIL
G19	272225.775	1530724.85E	12	SF340	NIL	NIL
G20	272226.205	1530725.82E	12	SF340	NIL	NIL
G21	272226.645	1530726.79E	12	SF340	NIL	NIL
G22	272227.085	1530727.75E	12	SF340	NIL	NIL
G23	272227.535	1530728.71E	12	SF340	NIL	NIL
G24	272225.075	1530724.09E	12	B350	NIL	NIL
G25	272224.655	1530723.13E	12	B350	NIL	NIL
G26	272224.265	1530723.79E	12	B350	NIL	NIL
G27	272223.475	1530723.89E	12	B350	NIL	NIL
G28	272222.795	1530724.26E	12	B350	NIL	NIL

Figure 11 General Aviation Apron Parking Positions

BAC Terminal Operations (07 3406 3171) administers the policies and procedures established for allocation and use of the designated aircraft bays.

Aircraft bay allocation is managed by the DTM and/or Control Coordinator utilising Airport resource management software system, Airport 20/20. Bay allocation rules are built into the system to ensure aircraft allocation is consistent with all information and any operating restrictions as reflected in the Apron Usability Charts or published in AIP-ERSA.

References

CASRs

139.170 *Aerodrome Markings*

CAO 20.9 *Precautions in refuelling, engine and ground radar operations*

MOS Part 139 - Aerodromes

Section 6.5 *Aprons*

Section 6.6 *Jet blast*

Section 8.5 *Apron Markings*

Section 9.16 *Apron Flood Lighting*

Section 9.17 *Visual Docking Guidance System*

Part 2

Section 10 - Airside Vehicle Control

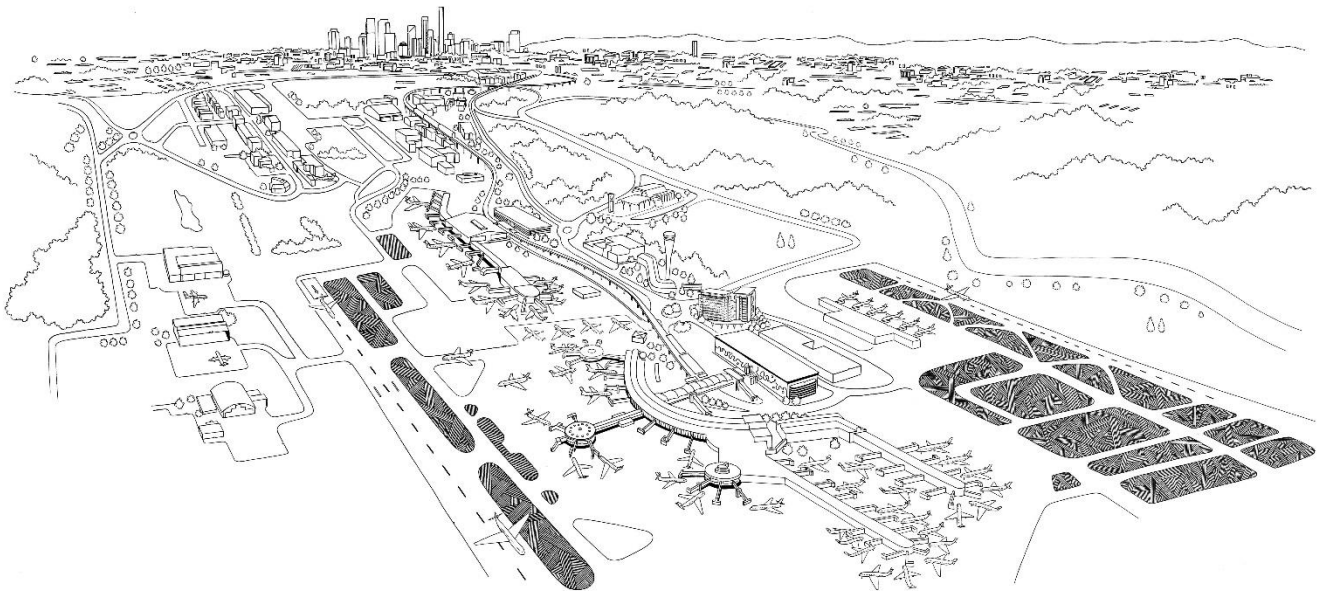

2.10 Airside Vehicle Control

As required by Appendix 1 to CASR subparagraph 139.095(a) (ii) this section provides particulars of the procedures for the control of surface vehicles operating on or near the movement area including details of the following:

- (i) The applicable traffic rules (including speed limits) and the means of enforcement of the rules;
- (ii) The method of instructing and testing drivers in relation to the applicable traffic rules;
 - Details of how records are managed
- (iii) The names, telephone numbers and roles of the persons who are responsible for airside vehicle control.

In accordance with CASR 139.100(3), the Brisbane Airport Airside Drivers Handbook ('Handbook') is an independent document to the Aerodrome Manual and is kept electronically. This is available on Working at Brisbane Airport website. It sets out the rules and procedures that control vehicles and drivers on the airside.

2.10.1 Authorities

BAC, as the operator of Brisbane Airport, has obligations under the *Civil Aviation Act 1988* and the *Aviation Transport Security Act 2004* in relation to safety and security issues associated with surface vehicles operating in such areas.

AC also has powers under the *Airports (Control of On-Airport Activities) Regulations 1997* and occupational health and safety legislation, to issue directions on matters concerning safety and security at Brisbane Airport, including the control of vehicles on the airside.

In addition, as occupier of the airport site, BAC has a general 'duty of care' at common law, which also entitles BAC to control movements of people and vehicles on the airside. BAC has produced the *Airside Drivers Handbook* the aim of which is to regulate and control the movement of vehicles and equipment to ensure the safe and efficient operation of the airside at Brisbane Airport.

2.10.2 Traffic Rules

Driving rules which apply to airside drivers and vehicles are details in *Rules for Drivers Operating Airside on Brisbane Airport (also known as "Airside Drivers Handbook")*. The Rules are available on BAC's website at

<http://www.bne.com.au/corporate/about-us/working-airport/airside-operations>

The rules deal with matters such as:

- Authority to Drive Airside (ADA);
- Authority to Use Airside (AUA); and
- Basic Safety Rules and Procedures including speed limits and operating requirements.

Any company wishing to operate vehicle(s) on the airside without escort by another ADA holder is required to obtain an Authority for Use Airside (AUA) and an Authority to Drive Airside (ADA) for each vehicle and driver respectively.

2.10.3 BAC Requirements

Aerodrome Reporting Officers and Airport Lighting Officers endorsed by BAC to enter operate and leave the manoeuvring area without obtaining a clearance from ATC must do so in accordance with the procedures and conditions set out in the Letter of Agreement between BAC and Airservices Australia (LOA 406). The letter is included in Attachment F.

Attachment F – Letter of Agreement (LOA) 406 BAC and Airservices



Clearance to Operate on the Manoeuvring Area – Brisbane Airport

Letter of Agreement

LoA_406

Version 10

Effective 27 August 2015

Between: Airservices Australia/East Coast Services North (Brisbane Tower)
Brisbane Airport Corporation Pty Ltd (BAC)

Authorised	Signature	Date
Doug Scott Manager, East Coast Services North Airservices Australia		7-8-15
Stephen Goodwin General Manager Operations Brisbane Airport Corporation Pty Ltd		17-8-15

This document remains valid until mutually amended or cancelled by written agreement of all parties



2.10.4 Driver Requirements

Each driver is approved to operate a vehicle airside on Brisbane Airport by an ADA issued under regulation 125 of the *Airports Control of On-Airport Activities Regulations 1997*. Each applicant for an ADA must hold a current State or Territory driver's licence endorsed for the specific type(s) of vehicle(s) to be operated or have a specialist equipment airline endorsement, and an approved Aviation Security Identification Card (ASIC) for Brisbane Airport.

The ADA specifies the area(s) where a driver is authorised operate, namely:

- Category 1 - perimeter roads;
- Category 2 - perimeter roads and aircraft stands;
- Category 2A - perimeter roads, aircraft stands and aprons; or
- Category 3 - movement areas - excluding runways;
- Category 3RWY (Runway) – all movement areas including runways.

Because a Category 3 and above ADA allows access to all movement areas it will only be issued to persons who also hold an appropriate Aviation Radio Operators Certificate (AROC).

It should be noted that ADA Category 2A will also only be issued to persons holding. AROC

2.10.5 Vehicle Requirements

The airside operation of each vehicle is approved by the issue of an AUA which must be displayed on the vehicle. For this purpose, the term vehicle includes any self-propelled vehicle or mobile equipment used in aircraft handling, servicing or maintenance. An AUA is issued under. *Airports (Control of on Airport Activities) Regulations 1997*,

Airside vehicles are to be registered, or meet a mechanical standard and condition acceptable to BAC. In the interests of airside safety, BAC may elect to inspect vehicles and suspend AUAs as necessary to ensure compliance with this provision.

Vehicles intended for use on the manoeuvring area must have an amber rotating/flashing beacon on the highest part of the vehicle or amber flashing lights visible through 360° (as required under MOS Part -139) and be equipped with two-way radio for communicating with Air Traffic Control (ATC), Brisbane Ground 121.7 MHz and Brisbane Tower 120.5MHz. Open cab vehicles must be fitted with headsets so that the driver can hear radio transmissions clearly.

Radio Transceiver Call signs are assigned on ATC's behalf by Aerodrome Operator (BAC).

Each company applying to operate vehicles airside is required to complete and sign a standard BAC Airside Vehicle Indemnity and Release.

2.10.6 A-SMGCS

All vehicles operating on the manoeuvring areas of Brisbane Airport are required to have electronic surveillance equipment installed and must comply with the technical specifications set out in MOS 139.

An exception is permitted for any vehicle that is closely escorted by another vehicle that complies with the regulation. The manoeuvring area includes runways and taxiways and does not include the aprons of terminal buildings or aircraft maintenance aprons or the perimeter access roads.

Attachment G – CASA Letter A-SMGCS

Attachment G – CASA Letter A-SMGCS



Australian Government
Civil Aviation Safety Authority

AIRSPACE AND AERODROMES REGULATION DIVISION
CASA file: EF10/3614

8th April 2013

Mr Peter Dunlop
Airside Operations Manager
Brisbane Airport Corporation
PO Box 61
Hamilton Central
Brisbane QLD 4007

Dear Mr Dunlop,

Designation of Brisbane Airport as an aerodrome to which Advanced Surface Movement Guidance and Control System (A-SMGCS) applies – Division 139.B.4 of Civil Aviation Safety Regulations (1998) Part 139

Airservices Australia has installed and recently operationally commissioned an Advanced Surface Movement Guidance and Control System (A-SMGCS) at Brisbane Airport for use by Air Traffic Control (ATC) for surface movement control and as a means of mitigation of the risk of runway incursions by aircraft and surface vehicles operating on the manoeuvring areas particularly during low visibility conditions. The A-SMGCS system provides the control tower with electronic surveillance of suitably equipped aircraft and surface vehicles operating on the aerodrome.

Civil Aviation Safety Regulations Part 139 and the Manual of Standards (MOS) Part 139 include regulatory requirements and standards for aerodromes to which A-SMGCS applies. The relevant regulations and technical standards appear at:

- a) Division 139.B.4 of CASR Part 139, including Regulations 139.251, 139.252 and 139.254; and
- b) MOS 139 section 10.9.4 being technical standards for electronic surveillance equipment fitted to vehicles.

In accordance with subregulation 139.252(1), CASA, by notice of this letter, hereby designates Brisbane Airport as an aerodrome to which A-SMGCS applies. The designation is made as CASA is satisfied, on the basis of a safety assessment submitted by Airservices Australia, that the use of A-SMGCS is necessary to ensure the safe control of aircraft and surface vehicles operating on the aerodrome's manoeuvring area. The date of the designation is 1 May 2013.

Subregulation 139.252(3) provides that the date of effect of the designation (i.e. the date that the provisions of Regulation 139.254 take effect) must not be less than 6 months after the date of the designation. In keeping with recent consultation with your office in relation to the timing to comply, CASA has accepted that a period of 12 months may be necessary for Brisbane Airport Corporation to manage the transition. CASA has therefore established the date of compliance with the designation to be 1 May 2014. Earlier compliance is not

precluded and if possible CASA requests Brisbane Airport to give priority to implementing the vehicle installations for those Inspection and Works Safety vehicles that routinely access runways.

Electronic surveillance equipment installed in any vehicles including those of Brisbane Airport Corporation, contractors, airlines and other air operator certificate holders that operate on the manoeuvring area, must comply with the technical specifications in MOS 139. An exception is permitted for any vehicle that is closely escorted by another vehicle that complies with the regulation. The manoeuvring area includes runways and taxiways and does not include the aprons of the terminal buildings or the aircraft maintenance aprons or the perimeter access roads.

The surveillance equipment which is necessary to be fitted to surface vehicles for the purpose of detection by A-SMGCS is termed Automatic Dependent Surveillance – Broadcast (ADS-B) equipment, which has similar functionality to the equipment installed in airline aircraft. The commercial terminology is 'vehicle locator' or 'veelo' equipment. Equipment fitted to a vehicle must be configured with a unique call-sign (e.g. CAR ONE) and a unique ICAO address code. The block of 200 continuous ICAO address codes assigned to Brisbane Airport Corporation for all vehicle allocations, other than the Airservices vehicles, is as follows:

ICAO Address	HEXADECIMAL	DECIMAL EQUIV.
Start	7CF501	8189185
End	7CF5C8	8189384

Brisbane Airport Corporation is requested to maintain an in-house register of the block of codes with the vehicle assignment for each code issued. It is also requested you confirm acceptance of the management and distribution of these 200 codes.

Audits of Brisbane Airport by CASA's Aerodrome Inspectors undertaken after 1 May 2014 may include assessment of compliance with the requirements of Regulation 139.254.

Should you or your staff have questions about the regulatory requirements or vehicle surveillance equipment or vehicle identification requirements, please contact Mr Greg Parnell, the CASA Aerodrome Inspector assigned to your aerodrome, in the first instance.

The cooperation of Brisbane Airport Corporation in implementing the processes to limit access to the manoeuvring area to A-SMGCS equipped vehicles should result in a significant reduction of the risk of runway incursions.

Yours sincerely,



Peter Cromarty
Executive Manager
Airspace and Aerodrome Regulation Division

2.10.7 Speed Limits

Aerodrome speed limits are detailed in the Brisbane Airport Airside Drivers Handbook

2.10.8 Enforcement

The *Airports (Control of On-Airport Activities) Regulations 1997* allow BAC to regulate the access and operation of vehicles on the airside. The Handbook is issued under the authority provided by this regulation.

The Airports (Control of On-Airport Activities) Regulations provide the legal basis for authorised BAC officers to enforce the rules established in the Handbook. Aerodrome Reporting Officers are authorised by BAC to control airside drivers, to issue warnings and record them against offending drivers. They log any breaches of the airside driving rules that they witness, and report them to the Airside Safety Systems Manager.

The Airside Safety Systems Manager or delegate has the authority to instigate disciplinary action and may withdraw or suspend an authorisation for a company to be an Approved Issuing Authority, an AUA, or the ADA of a person who breaches the conditions of the Handbook.

2.10.9 Airside Safety Committee

BAC has established an Airside Safety Committee. The purpose of this Committee is to discuss and share relevant safety information in a relaxed and open atmosphere so as to maximise the learning and development of ideas to improve safety. The primary aim of the Airside Safety Committee is to:

- Provide a safe environment for the travelling public, airport users, airport employees and aircraft at Brisbane Airport;
- Provide local oversight of airside safety issues with particular focus on the dissemination and sharing of findings and lessons learnt, evaluating the safety efficacy of new initiatives and making recommendations for procedural improvements, where appropriate;
- To eliminate and / or reduce hazardous conditions, acts and situations as low as reasonably practicable, as well as to prevent and / or reduce accidents, incidents and occurrences as low as reasonably practicable.
- To promote positive safety attitudes, culture, lateral thinking and new technology through collaboration of all organisations working airside.

2.10.9.1 Airside Safety Committee members

The Committee consists of representatives from the airlines, handling agents, aircraft cleaning companies, aircraft catering companies, refuelling companies, Government agencies, Air Traffic Control.

2.10.9.2 Airside Safety Committee procedures

The Airside Safety Committee will hold ordinary meetings on a quarterly basis, at the offices of BAC or another suitable site of another member. Extraordinary meetings may also be called where it is considered necessary to consider a serious safety issue on an urgent basis.

The Airside Safety Systems Manager will issue an agenda, together with any necessary supporting material, prior to each meeting of the Airside Safety Committee.

The Airside Safety Systems Manager will ensure that minutes are taken of each Airside Safety Committee meeting, and that these minutes are distributed via email to members before the next ordinary meeting.

2.10.10 Records

The records of ADAs and AUAs are kept on database administered by the Airside Safety Systems Manager.

2.10.11 ADA Testing

BAC is the issuing authority of AUA/ADA applications. Applicants for an ADA are assessed for level of competency in the knowledge of:

- rules for Drivers Operating Airside on Brisbane Airport;



- geography of Brisbane Airport;
- markers, markings and signs; and
- standard company operating procedures on the airside.

2.10.12 Escorts

Other vehicles and drivers are permitted to operate airside if escorted by, or under the control of, an Aerodrome Reporting Officer or other airside drivers holding an appropriate ADA for the area where the escorted vehicle is being taken. An escorting driver will be responsible for any airside driving offences committed by a driver he/she is escorting.

2.10.13 Roles and Responsibilities

The Managing Director/CEO has the responsibility and the authority to control persons and vehicles entering and operating airside at Brisbane Airport.

The General Manager Operations or delegate ensures that the provisions of the Handbook are implemented and that amendments are issued as necessary. He/she has the discretion to determine which persons and vehicles are permitted airside.

The Airside Safety Systems Manager or delegate has the authority to instigate disciplinary action and may withdraw or suspend an ADA or AUA as necessary.

Aerodrome Reporting Officers authorised by BAC to control airside drivers issue warnings and record them against offending drivers. This is supplemented by a points system which has been introduced into the Handbook, where demerit points are recorded against offending drivers, and may result in ADA suspension if a certain number of points are accumulated over a given period.

The telephone numbers of BAC staff nominated in this procedure can be found on the Telephone Contact List at the front of the Manual.

References

CASR

83 *Use and operation of radio communication systems by Australian aircraft*

83A *Aviation Radio Operators Certificate: issue*

83C *Aviation Radio Operators Certificate: conditions*

MOS Part 139 – Aerodromes

Section 10.9 Control of Airside Access Including Vehicle Control

Airports (Control of On-Airport Activities) Regulations

Part 4 Division 4 Airside vehicle operation

Part 2

Section 11 - Wildlife Hazard Management

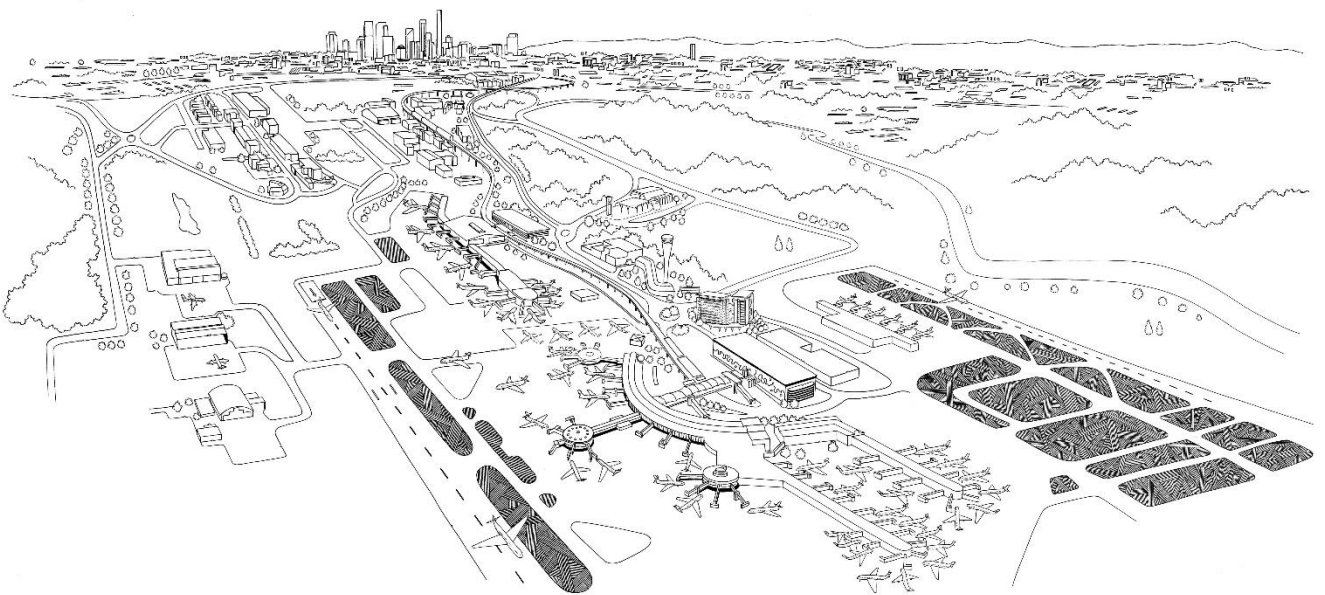

2.11 Wildlife Hazard Management

To meet the requirements of Appendix 1 to CASR subparagraph 139.095(a) (ii) this section deals with the particulars of the procedures to deal with danger to aircraft operations caused by the presence of birds or animals on or near the aerodrome

All bird and animal strikes will be reported to ATSB.

Particulars of the procedures to deal with danger to aircraft operations caused by the presence of birds or animals on or near the aerodrome, including details of the following:

- (i) The arrangements for assessing any bird or animal hazard;*
- (ii) The arrangements for the removal of any bird or animal hazard;*

Details of licences and permits, if applicable.

- (iii) The names and roles of the persons responsible for dealing with bird or animal hazards, and the telephone numbers for contacting them during and after working hours.*

The Brisbane Airport *Wildlife Hazard Management Plan (WHMP)* is published and distributed independently of the Aerodrome Manual. It provides a strategy for identifying and minimising wildlife hazards on Brisbane Airport. In accordance with CASR 139.100(3) the *WHMP* has been adopted as *Annex 4* to this Manual.

2.11.1 Wildlife Hazard

Birds and animals in general are a threat to air safety, particularly if they are present on the airport and in the vicinity of runways. Formal procedures have been developed to manage bird & wildlife hazards and if possible eliminate the potential for a bird strike with aircraft on landing or take-off. Precautions are also taken to prevent animal access to the movement area where they would pose a serious hazard for aircraft operations.

2.11.2 Data collection

The Aerodrome Reporting Officers routinely monitors bird activity on Brisbane Airport:

- during daily serviceability inspections;
- by bird counts carried out daily (0700-0830L); and
- as required if there is a particular problem, e.g. large numbers present on airport.

The Wildlife Control Coordinator and Aerodrome Reporting Officers undertake additional monitoring when there is unusual bird activity or they receive reports/complaints from airport users.

Aerodrome Reporting Officers conduct bird counts to record the types and numbers of birds on the airport. The number of each species present is recorded in Tracker Airside.

Eleven (11) count areas have been nominated with each representing either a different potential bird hazard or a discrete environment which may attract particular bird species. Bird count data is recorded in the bird count database.

If directed, the Aerodrome Reporting Officers also note bird flight paths, times of regular bird movements, feeding attractions such as grain, seeds, insects, mice, lice) and other times of day at which bird flocks are present.

If an Aerodrome Reporting Officer is required to disperse birds shortly before a scheduled bird count, he/she records the number and species dispersed in lieu of the normal count.

2.11.3 Bird strikes

Confirmed Strikes observed by, or reported to, the Aerodrome Reporting Officers are recorded in Tracker Airside and OCA Noggin. Airside Operations Team Leader's enter the data and the generated report is emailed to a defined "Bird Strike Distribution List" which includes Airlines and internal management. The Airside Wildlife Coordinator or delegate is responsible for sending the report to the ATSB. An example of the bird strike report generated is included as Attachment H.

Attachment H – Bird Strike Report

WILDLIFE STRIKES TRACKER		TKRA 017			
Full Name >		Job Title >		Date >	
E-mail >		Start Time >		Form Duration >	
Mobile >		Submit Time >			
		Start GEO Location >			
		Submit GEO Location >			
DATE / TIME OF STRIKE		LOCATION		TIME OF STRIKE NOTIFIED BY TOWER	
SPECIES TYPE				SPECIES ACTIVITY	
				SPECIES RISK RANKING	
# WILDLIFE STRUCK		# CARCASSES FOUND		WEATHER INFORMATION AT TIME OF STRIKE	
AIRCRAFT AND FLIGHT DETAILS					
AIRCRAFT TYPE		AIRCRAFT REGO		WIND DIRECTION	
AIRCRAFT OPERATOR				WIND SPEED	GUSTS SPEED
TYPE OF OPERATION		FLIGHT NUMBER			
ARRIVAL OR DEPARTURE				CLOUD HEIGHT	
		FLIGHT RULES		CLOUD AMOUNT	
PHASE OF FLIGHT	EFFECT ON FLIGHT	FLIGHT CONDITION		VISIBILITY	LIGHT CONDITIONS
		RUNWAY		RAINFALL IN LAST 24 HRS	
ARRIVING FROM		DEPARTING TO		TEMPERATURE	

WILDLIFE STRIKES TRACKER		TKRA 017			
STRIKE DETAILS					
STRIKE STATUS	2.Suspected – Nil find	STRIKE SIGNIFICANCE	1.Low		
SIZE OF WILDLIFE	Nil Found	DAMAGE TO AIRCRAFT	4.Nil		
CARCASSES LABELLED AND STORED	No	FLIGHT DELAY CAUSED	No		
DNA SAMPLE TAKEN	No	REPORTED BY AIRCRAFT	Yes		
REPORTED BY AIRPORT TRAFFIC CONTROLS OR OPERATIONS CENTRE	Yes				
ACTUAL CONSEQUENCE					
0. Near Miss/ Unconfirmed					
OTHER ADDITIONAL INFORMATION					
<div style="border: 1px solid black; height: 100px; width: 100%;"></div>					
<p>SIGNATURE</p> <p>Ross Gillespie</p>					

No Photo or Video Captured

2.11.4 Significant Strike Reporting Procedure

It is the responsibility of the Airside Operations Manager to ensure the significant strike reporting procedure detailed in the Wildlife Hazard Management Plan (WHMP) is followed when such an incident occurs.

Objective	Responsibilities	Timing	Equipment	Definition
To implement a procedure that allows for rapid response and detailed investigation and reporting of significant wildlife strikes at Brisbane Airport	Airside Operations (AO) Officers (AO) Team Leaders (AO) Coordination Manager Airside Wildlife Coordinator Airside Operations Manager	Reporting to ATSB within 72 hours of the significant strike occurring	Significant Strike Incident Investigation Checklist <i>(Attachment I)</i> Significant Strike Incident Investigation Report	A significant wildlife strike is deemed to have occurred whenever: There is damage evident on the aircraft due to a strike and/or There is an effect on flight (i.e. delays of 60 minutes or more, cancellations due to aborted takeoff or a precautionary return to the airport)

Figure 12 – Significant Strike Reporting Procedure

Attachment I – Significant Strike Reporting Checklist

Checklist Actions	Check on completion
Undertake standard strike response, including notifying AOM & WC immediately following a significant strike occurrence.	<input type="checkbox"/>
Undertake runway inspection. Note runway chainage location of any remains.	<input type="checkbox"/>
Recover any wildlife remains, bag and tag, and place in remains storage fridge.	<input type="checkbox"/>
Undertake DNA sampling of any smears if carcass is unidentifiable (use DNA kits supplied). Correctly mark the DNA kit slip and dispatch samples to the Australian Museum ASAP.	<input type="checkbox"/>
Obtain photographs of damage, remains etc.	<input type="checkbox"/>
Note specific weather conditions at time of strike.	<input type="checkbox"/>
Record any details of discussions with pilots, ATC, engineers or maintenance staff in Wildlife Strike Report.	<input type="checkbox"/>
Note details of any bird attractions present at the time of strike (i.e. maintenance, contractor activities, insects, frogs etc.) in Wildlife Strike Report.	<input type="checkbox"/>
Prepare and distribute Wildlife Strike Report in Bird Strike Database.	<input type="checkbox"/>
Obtain copies of NOTAM's current at the time of the strike incident (referring to wildlife hazards only)	<input type="checkbox"/>
WC to supply detailed harassment hours for 2 days prior to incident.	<input type="checkbox"/>
Ensure the hazard is no longer present or has been appropriately managed otherwise issue a NOTAM.	<input type="checkbox"/>
WC to obtain Bird Count Database records for the previous 2 weeks.	<input type="checkbox"/>
WC to obtain Wildlife Cull records for the previous 2 weeks.	<input type="checkbox"/>
WC to obtain a statement on the maintenance activities at the time of the incident and 2 days before. (Civil Maintenance Coordinator).	<input type="checkbox"/>
WC to obtain copies of the Daily Duty Logs for the day, and for the 2 days prior and after the strike, and obtain a copy of the airline incident report.	<input type="checkbox"/>
WC to obtain tide records and other meteorological information for the day, and for the 2 days before the strike incident. (Bureau of Meteorology)	<input type="checkbox"/>
AOO's to increase wildlife hazard surveillance for 2 days after the strike occurring to determine whether the species struck is prevalent or isolated. Ensure data is recorded in Tracker Airside.	<input type="checkbox"/>
Request short turnaround of DNA investigation results (if required).	<input type="checkbox"/>
If carcass is identifiable, facilitate autopsy to determine cause of death and stomach contents analysis with veterinarian. Request short turnaround.	<input type="checkbox"/>
Obtain copies of any emails, file notes, reports, relevant to reporting of wildlife hazards at the time.	<input type="checkbox"/>
WC to develop Significant Wildlife Strike Report.	<input type="checkbox"/>

2.11.5 Animal incursions and strikes

The Aerodrome Reporting Officers monitor the movement area for signs of animal fence incursions or collision with aircraft during the daily serviceability inspections and record their findings in Tracker Airside.

The Airside Operations Team Leader records this information on incursions or strikes in Tracker Airside.

2.11.6 Hazard Assessment

On the basis of data collected daily, the Airside Wildlife Coordinator and Aerodrome Reporting Officers decide the level of hazard to aircraft by carrying out a risk assessment. If it is determined the risk is moderate to severe a NOTAM is raised.

The Airside Wildlife Coordinator and delegate undertake the assessment of the data recorded in the database to:

- assist in reviewing and developing appropriate management strategies;
- review the wildlife hazard risks and adjusting standard operating procedures as necessary; and
- ensure Aerodrome Reporting Officers have an adequate level of training in species identification and trend analysis.

The Airside Coordination Manager and Wildlife Control Coordinator may also undertake wildlife studies to assist in the understanding and management of particular wildlife hazards. In cases where an aircraft has suffered damage, the Wildlife Control Coordinator, or delegate forwards a report to ATSB.

Information on the arrangements for the removal of any bird or animal hazard can be found below.

2.11.7 Bird Control

The Airside Operations Manager or delegate acts on advice received from the Airside Coordination Manager and the Environment & Sustainability Manager to reduce and/or control the airport bird population.

If birds are observed on or near a runway, runway strip and/or the closely associated taxiways where they may threaten safe aircraft operations, the Aerodrome Reporting Officers harass and disperse them.

The first method of harassment and dispersal is to use vehicle lights, sirens and horns. If this technique does not have the desired effect, pyrotechnic ammunition is used. Live shot is used only as a last resort. Both the timing of, and the harassment technique applied will be such to ensure birds and bird flocks are not startled into the paths of approaching aircraft.

Aerodrome Reporting Officers record harassment hours and management action in Tracker Airside.

2.11.8 Animal Control

The Aerodrome Reporting Officers conduct animal harassment and dispersal. Techniques include the use vehicle lights, sirens and horns. If this technique does not have the desired effect qualified contractors are engaged to remove/trap/cull nuisance animals as a last resort.

BAC undertakes a maintenance program to ensure airside perimeter fences and gates are in good order to prevent incursions. All gates and airside access points are kept closed at all times. If pursuing animals, staff take care not to frighten them into the path of aircraft on the movement area and also try to avoid frightening animals potentially causing damage to aircraft.

2.11.9 Licences and Permits

BAC Airside Operations Centre Staff and all firearms provided for their use are licensed in accordance with the Weapons Act 1990 (Qld).



BAC is licensed by the Department of Environment and Heritage Protection (DEHP) Under the *Nature Conservation Act 1992* to destroy birds causing a potential aircraft safety hazard on Brisbane Airport. Application for a damage mitigation permit (DMP) is submitted by the Airside Wildlife Coordinator, with a return of operations sent to DEHP every 3 months for compliance.

2.11.10 Habitat and Land Management

Ground maintenance and cleaning contractors are required to routinely check public areas at the airport and remove any attractions left by the public such as litter and food scraps. Aerodrome Reporting Officers ensure all carry on and litter on the airside are removed and monitor the movement area for water ponding. Regular mowing reduces the chances of grass setting seed.

On-airport development, works or landscaping are planned with consideration given to wildlife control management. Wherever possible, restrictions are imposed on new developments adjacent to the airport to prevent wildlife hazards. Checking of possible wildlife attractions is undertaken at each technical inspection or as required.

2.11.11 Roles and Responsibilities

The Airside Operations Manager, or delegate, in conjunction with the Airside Coordination Manager, Wildlife Control Coordinator and Environment & Sustainability Manager are responsible for developing the Wildlife Hazard Management Plan.

The Wildlife Control Coordinator and duty Aerodrome Reporting Officers implement the plan. They are required to identify significant wildlife hazards at the airport and take appropriate reporting and control action.

The Wildlife Control Officer and duty Aerodrome Reporting Officers carry out wildlife harassment and dispersal. They are authorised to use appropriate firearms and both pyrotechnic and live ammunition but only while on Brisbane Airport property.

Both the Airside Coordination Manager and Wildlife Control Coordinator oversee Aerodrome Reporting Officers wildlife management activities and maintain relevant databases and hard copy records.

The telephone numbers of BAC staff nominated in this procedure can be found on the Telephone Contact List at the front of the Manual.

References

CAR 96 Dumping of Rubbish

MOS Part 139 Aerodromes

Section 10.14 Wildlife Hazard Management

Other

BAC Wildlife Hazard Management Plan

Part 2

Section 12 - Obstacle Control

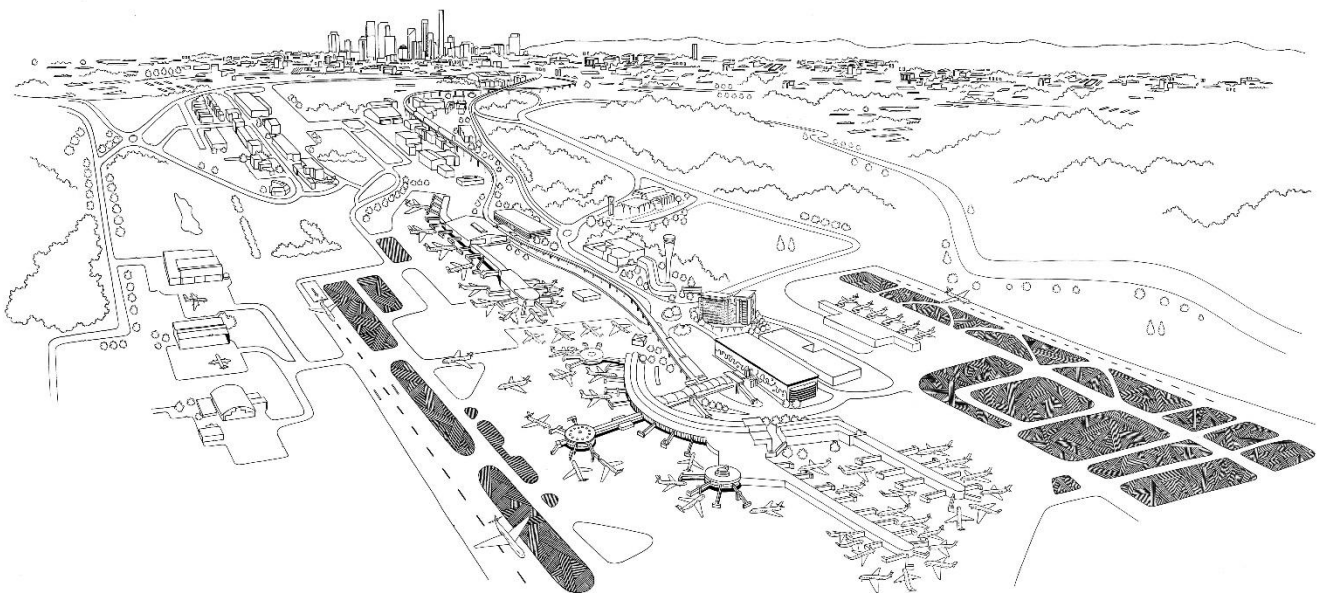

2.12 Obstacle Control

To meet the requirements of Appendix 1 to CASR subparagraph 139.095(a) (ii) this section deals with particulars of:

- (i) *The procedures for monitoring the obstacle limitation surfaces and the Type A chart take-off surface for obstacles;*
OLS approach/take-off surveys are conducted annually by a consultant and records are kept of all surveys.
- (ii) *The procedures for monitoring building developments (in relation to the height of buildings and other structures) within the horizontal limits of the obstacle limitation surfaces;*
- (iii) *If the aerodrome has instrument approach procedures — the procedures for monitoring for new objects or building developments in any other areas nominated by the instrument procedure designers;*
Have drawings been received from procedure designer showing pans ops surfaces and obstacle information?
Method for advising procedure designer of change of the status of critical obstacles.
- (iv) *The arrangements between CASA, local planning authorities and other relevant organisations in relation to the approval of building developments that may infringe the obstacle limitation surfaces;*
- (v) *The names, telephone numbers and roles of the persons responsible for planning and implementing obstacle control.*

2.12.1 OLS and Type A Surveys

The Airside Standards Manager or delegate arranges OLS surveys as detailed in *Part 2, Section 7 Technical Inspections* of the Manual.

The Type A charts for Brisbane Airport are updated as required in accordance with the requirements of the *Manual of Standards Part 139 - Aerodromes*.

New permanent structures are surveyed during the OLS check or Type A update to determine if changes in Aeronautical Information Package will need to be advised. Changes are advised in accordance with the procedures described in *Part 2, Section 4 (Airport Reporting)* of the Manual.

Results of the annual OLS survey are presented in the airport technical inspection report. The Type A chart is amended at two yearly intervals following the update survey. The Airside Standards Manager or delegate maintains the distribution list for Type A Chart notifications and Type A Chart records.

The latest Type A charts can be found in Attachments J RWY 01R/19L and K RWY 14/32 respectively.

Attachment J – Type A Chart RWY 01R/19L

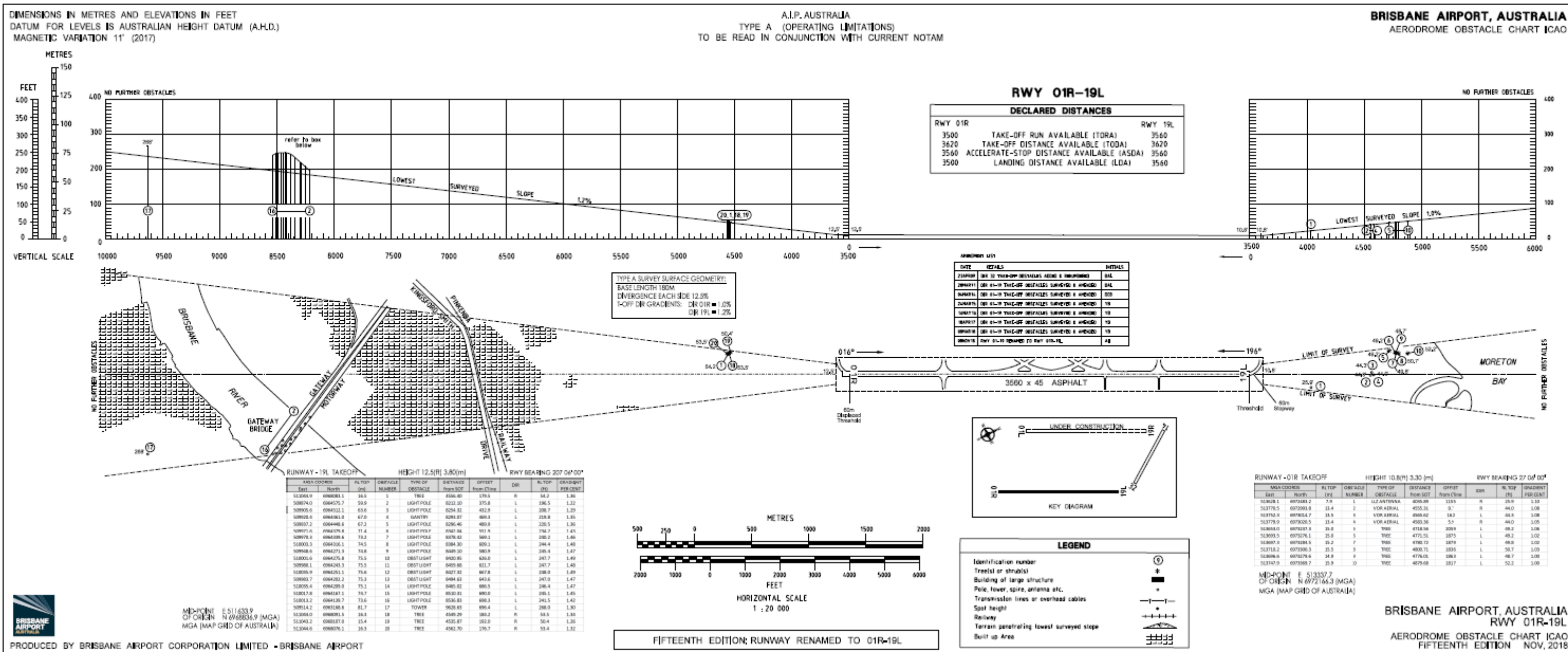

Attachment I – Type A Chart RWY 14/32

DIMENSIONS IN METRES AND ELEVATIONS IN FEET
 DATUM FOR LEVELS IS AUSTRALIAN HEIGHT DATUM (A.H.D.)
 MAGNETIC VARIATION 11° (2017)

A.I.P. AUSTRALIA
 TYPE A (OPERATING LIMITATIONS)
 TO BE READ IN CONJUNCTION WITH CURRENT NOTAM

BRISBANE AIRPORT, AUSTRALIA

AERODROME OBSTACLE CHART ICAO

AMENDMENT LIST

DATE	DETAILS	INITIALS
20SEP11	DIR 32 No 7 RL FT. DIR 14 No 2 GRADIENT CORRECTED	BAL
20FEB13	DIR 14 TAKE-OFF OBSTACLES ADDED & RENUMBERED DIR 32 TAKE-OFF OBSTACLES SURVEYED & AMENDED	DCB
18MAR13	DIR 14-32 TAKE-OFF OBSTACLES SURVEYED & AMENDED	DCB
23MAR15	DIR 14-32 TAKE-OFF OBSTACLES SURVEYED & AMENDED	YB
17MAY16	DIR 14-32 TAKE-OFF OBSTACLES SURVEYED & AMENDED	YB
18APR17	DIR 14-32 TAKE-OFF OBSTACLES SURVEYED & AMENDED	YB
05NOV18	DIR RWY 01-19 RENAMED TO RWY 01R-19L	AH

DECLARED DISTANCES

RWY 14		RWY 32
1700	TAKE-OFF RUN AVAILABLE (TORA)	1700
1760	TAKE-OFF DISTANCE AVAILABLE (TODA)	1760
1700	ACCELERATE-STOP DISTANCE AVAILABLE (ASDA)	1700
1700	LANDING DISTANCE AVAILABLE (LDA)	1700

TYPE A SURVEY SURFACE GEOMETRY:
 BASE LENGTH 180M
 DIVERGENCE EACH SIDE 12.5%
 T-OFF DIR GRADIENTS: DIR 14 = 1.2%
 DIR 32 = 1.2%

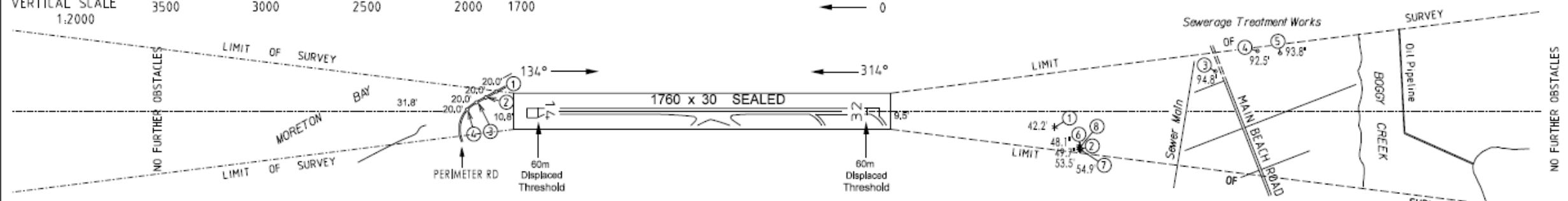
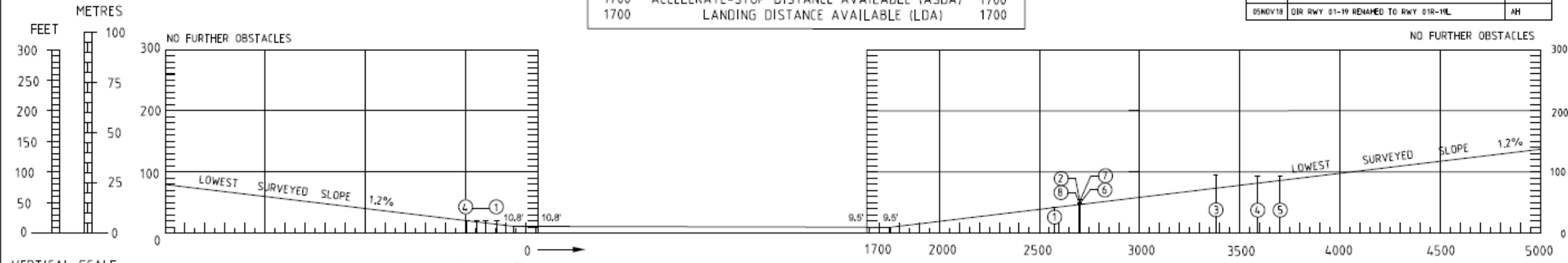

RUNWAY - 32 TAKEOFF HEIGHT 10.8(ft) 3.3 (m) RWY BEARING 325°35'04"(T)

MGA COORDS		RL TOP (m)	OBSTACLE NUMBER	TYPE OF OBSTACLE	DISTANCE from SOT	OFFSET from C'line	DIR	RL TOP (ft)	GRADIENT PER CENT
East	North								
512274.9	6974301.3	6.1	1	T.O.*	1847.07	98.4	R	20.0	3.19
512220.3	6974329.5	6.1	2	T.O.*	1901.20	69.3	R	20.0	1.97
512172.9	6974353.7	6.1	3	T.O.*	1947.95	43.8	R	20.0	1.48
512118.3	6974371.8	6.1	4	T.O.*	1993.75	9.0	R	20.0	1.19

MGA (MAP GRID OF AUSTRALIA) MID POINT E 512245.8 OF ORIGIN N 6974176.1 (MGA)
 T.O.* TRANSIENT VEHICLE HT 4 (m) 13.1 (ft) ON PERIMETER ROAD.

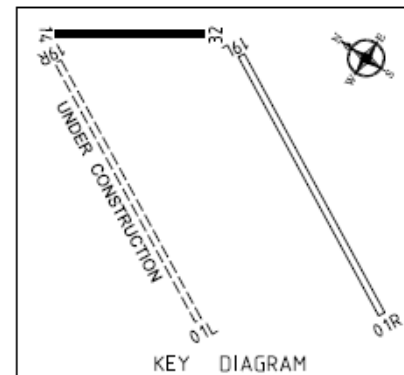

RUNWAY - 14 TAKEOFF HEIGHT 9.5(ft) 2.90 (m) RWY BEARING 145°35'04"(T)

MGA COORDS		RL TOP (m)	OBSTACLE NUMBER	TYPE OF OBSTACLE	DISTANCE from SOT	OFFSET from C'line	DIR	RL TOP (ft)	GRADIENT PERCENT
East	North								
513701.8	6971904.0	12.9	1	TREE	2576.23	79.5	R	42.2	122
513681.7	6971739.5	16.3	2	TREE	2700.61	189.1	R	53.5	143
514383.9	6971400.7	28.9	3	LIGHT POLE	3377.02	198.7	L	94.8	161
514585.9	6971284.4	28.2	4	LIGHT POLE	3587.14	299.6	L	92.5	138
514640.5	6971185.0	28.6	5	LIGHT POLE	3700.00	288.5	L	93.8	132
513693.3	6971749.0	14.7	6	TREE	2699.33	174.2	R	48.1	125
513682.0	6971735.7	16.7	7	TREE	2703.96	191.0	R	54.9	146
513684.8	6971744.4	15.2	8	TREE	2698.29	183.8	R	49.7	131

MGA (MAP GRID OF AUSTRALIA) MID POINT E 513308.3 OF ORIGIN N 6972625.1 (MGA)

LEGEND

Identification number	⑨
Trees) or shrubs)	*
Building or large structure	■
Pole, tower, spire, antenna etc.	o
Transmission lines or overhead cables	—T—T—T—
Spot height	.
Railway	—+—+—+—+—
Terrain penetrating lowest surveyed slope	~
Built up Area	▨▨▨▨

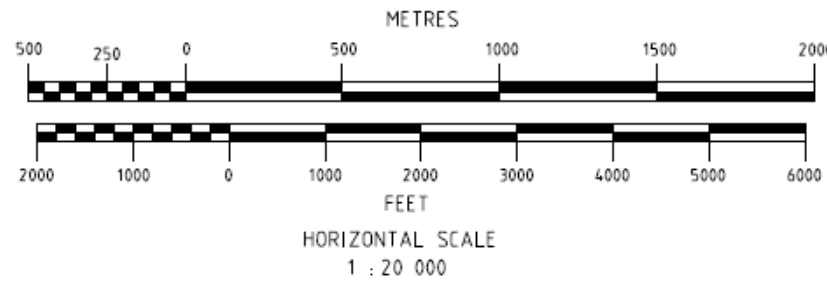

BRISBANE AIRPORT, AUSTRALIA

RWY 14-32

AERODROME OBSTACLE CHART ICAO
 FIFTEENTH EDITION NOV 2018

PRODUCED BY BRISBANE AIRPORT CORPORATION LIMITED - BRISBANE AIRPORT

FOURTEENTH EDITION: OBJECT SURVEY CHANGES INCORPORATED.

CAD FILE /

2.12.2 Daily monitoring

Aerodrome Reporting Officers utilise Tracker Airside (Figure 8), OLS drawings to monitor the OLS, Type A chart take-off surfaces, and critical PANS-OPS surfaces during their airport serviceability inspections. They monitor for cranes, or other temporary obstacles, and check compliance with conditions agreed for their operation.

If a temporary obstacle is erected without prior notification and detected during the airport serviceability inspection, the Aerodrome Reporting Officer has it removed immediately if the obstacle is on airport and notifies the Airside Standards Manager. If the obstacle is off airport he/she ensures that:

- ATC is advised immediately;
- NOTAM action is initiated if required;
- if necessary amended declared distances are advised;
- he/she attempts to negotiate its removal, and if unsuccessful advises the Airside Standards Manager, or delegate of the obstacle; and
- Once the obstacle is removed, ATC is advised and the NOTAM (if any) is cancelled.

Aerodrome Reporting Officers record details of the daily serviceability inspections within Tracker Airside and any specific actions taken subsequently to deal with any new temporary or permanent obstacle.

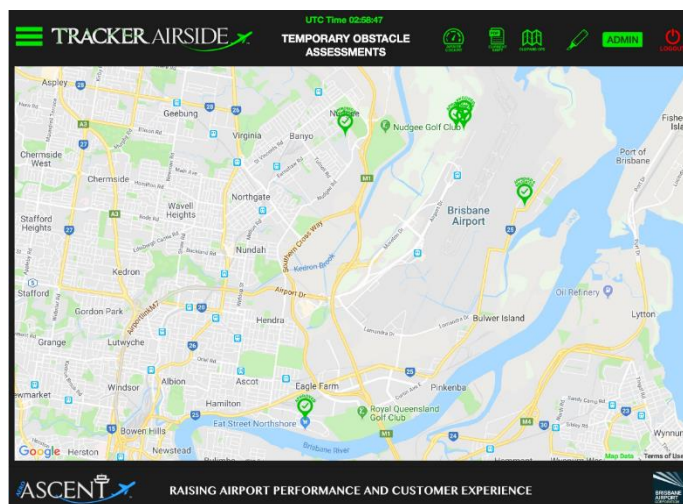

Figure 13 – Tracker Airside Temporary Obstacle Assessments

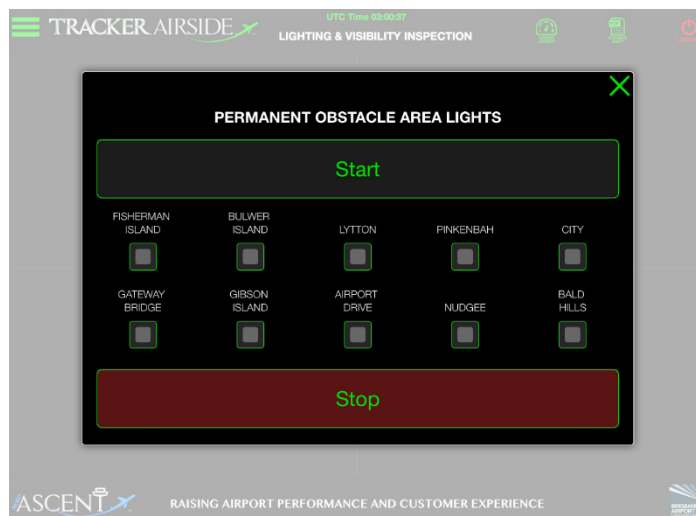

Figure 14 – Tracker Airside Permanent Obstacle Area lights Assessments

The Manager, or delegate, of Airport Planning identifies and negotiates long term protection arrangements for the airport's "prescribed airspace" under *Regulation 5 of the Airports (Protection of Airspace) Regulations 1996*. He/she ensures that building control authorities are aware of the extents and implications of the "prescribed airspace" for Brisbane Airport, and assists in the preparation of their development assessment procedures where possible.

If BAC becomes aware of a proposed development which is likely to infringe PANS-OPS surfaces in applying the procedures in the following subsection the Airside Operations Manager, or delegate informs the Airservices Australia Procedure Design Section as required by *Part 2, Section 4 Airport Reporting* of the Manual. Under *Regulation 9 of the Airports (Protection of Airspace) Regulations 1996*, BAC notifies the proponent that the proposal will infringe PANS-OPS surfaces is unable to be approved.

2.12.3 Administration

Department of Infrastructure Regional Development and Cities (DIRDCC) requires proposals to undertake "controlled activities" of a temporary or permanent nature, or to alter an existing structure, to be submitted to BAC for approval if likely to infringe the airport's "prescribed airspace".

Airside Operations Centre provides a 24 hour contact point for proposals to undertake temporary "controlled activities".

NOTAM's advising details of temporary obstacles are raised in accordance with the procedures detailed in *Part 2, Section 4 (Airport Reporting)* of the Manual. Applications/referrals concerning permanent structures or facilities are directed to the Airside Standards Manager, or delegate for assessment. He/she maintains a file of all enquiries.

If a detailed assessment is necessary (for either a temporary or proposed permanent "controlled activity") the Airside Standards Manager, or delegate co-ordinates the assessments, liaising as required with ASA and CASA.

Applications to undertake "controlled activities" are assessed in accordance with the DIRDCC guidelines. Each assessment is registered on an activity database and, when completed, all relevant correspondence and the applications and completed pro-formas are filed.

Under the *Airports (Protection of Airspace) Regulations 1996* BAC has accepted a delegation of authority from DIRDCC to approve short term "controlled activities" of less than 3 months. The authority is delegated to:

- General Manager Operations;
- Airside Standards Manager.

Notwithstanding this delegation of authority, short term "controlled activities" may be referred to DIRDC for decision at BAC's discretion.

The Airside Standards Manager or delegate maintains a register of all enquiries received which require an obstacle/operational assessment.

All records of decisions made in assessing the operational impact of a proposed structure are filed by the Airside Standards Manager, or delegate.

2.12.4 Short term Controlled Activities

Under the *Airports (Protection of Airspace) Regulations 1996*, a 'short term controlled activity' is defined as an activity that will be carried out for no longer than 3 months.

Crane operations are assessed and responded to using the *Brisbane Airport – Proponents Crane Application* included as Attachment L.

Crane operations are assessed against the "prescribed airspace" for the existing airport, the inner OLS component being included as Attachment M, and the overall (OLS & PANS-OPS) component as Attachment N.

Short-term "controlled activities" other than crane operations are assessed giving consideration to non-structural impacts including air turbulence.

All proposals which constitute or potentially constitute “controlled activities” (including construction equipment) are referred to CASA and AA for an operational assessment and hazard determination. BAC has a delegation of authority from DIRDC to approve short-term “controlled activities”. At BAC’s discretion approval authority may be referred back to DIRDC.

Where a crane operation has been agreed subject to special conditions such as painting and/or lighting, or restricted operating times, the Airside Standards Manager, or delegate advises details to Airport Operations Centre so that the duty Aerodrome Reporting Officer can monitor compliance. All crane operation approvals are copied to both Airside Operations Centre and ASA ATC Team Leader for information.

2.12.5 Permanent or Long Term Controlled Activities

Permanent or long-term “controlled activities” are assessed using the *Brisbane Airport - Development Assessment – Airspace Impact* pro-forma included as Attachment O.

DIRDC is the approval authority for permanent or long-term “controlled activities”. They are assessed against the “prescribed airspace” for the master planned airport facilities, the OLS component being included as Attachment M, and the PANS-OPS component as Attachment N.

Artificial and reflected lighting from proposed developments and facilities are assessed against the drawing included as Attachment Q and CASA’s Manual of Standards Section 9.21 *Lighting in the Vicinity of Aerodromes* included as Attachment Q. All proposals which constitute or potentially constitute “controlled activities” (including construction equipment) are referred to CASA and ASA for an operational assessment and hazard determination.

2.12.6 PANS-OPS Considerations

PANS-OPS surfaces used in deriving the published minima for the current Brisbane Airport instrument approach procedures have been identified and are shown on the drawing included as Attachment N.

If permitted, new structures which exceed these limits will raise the published minima for one or more of these procedures. In turn this may reduce the all-weather capability of the airport.

PANS-OPS surfaces for the ultimate airport development have been developed in consultation with CASA and ASA and are available in the Brisbane Airport Corporation Masterplan.

The provisions of the *Airports (Protection of Airspace) Regulations 1996* require BAC to reject any “controlled activity” that infringes PANS-OPS surfaces without further consultation. However, in certain circumstances, and in close consultation with ASA some PANS-OPS intrusions by “short-term controlled activities” may be conditionally agreed by BAC.

2.12.7 OLS Considerations

Except where PANS-OPS surfaces are protected in preference to the OLS (i.e. where they are lower than the OLS at a particular point) “controlled activities” may be undertaken up to the OLS limits without an operational or hazard assessment.

All “controlled activities” which will exceed the vertical limits of the OLS (including non-structural intrusions and construction equipment) are referred to CASA and ASA for an operational assessment and hazard determination.

OLS infringements may be permissible with the appropriate hazard marking by painting and/or obstruction lighting in accordance with CASA recommendations. CASA will apply shielding principles in their hazard determination, however, the expected life-span of the shielding structure is considered in the recommendations for hazard marking.

BAC in making a submission to DIRDC on a proposed “controlled activity”, will always emphasise that approval should not be granted if it will affect the safety, efficiency or regularity of existing or future air transport operations at Brisbane Airport, since this is contrary to the intent of the “prescribed airspace” legislation.

2.12.8 Non-Structural Controlled Activities

Non-structural “controlled activities” have the potential to impact on the safety of aircraft operations with the added difficulty of the inability to make them conspicuous by hazard marking. Development proposals that include stacks or vents that discharge into the atmosphere will require assessment against the relevant standards.

CASA will generally require a scientific analysis report of the proposed stack discharge to allow their hazard determination.

Proposals that include facility lighting, and/or large reflective surfaces will also have to be reviewed by CASA for potential impact on aircraft operations. BAC will require proponents to supply sufficient technical data to facilitate CASA’s determinations.

2.12.9 Roles and Responsibilities

The General Manager Operations, or delegate has overall responsibility for establishing procedures;

- to protect the airport’s “prescribed airspace”, and
- to monitor and notify obstacles to CASA, and
- to control the erection of new obstacles in the vicinity of Brisbane Airport.

Airport Planning identifies and negotiates long term protection arrangements for the airport’s “prescribed airspace” under regulation 5 of the *Airports (Protection of Airspace) Regulations 1996*. He/she ensures that building control authorities are aware of the extents and implications of the “prescribed airspace” for Brisbane Airport, and assists in the preparation of their development assessment procedures where possible.

The Airside Standards Manager, or delegate co-ordinates measures to monitor and protect the airports “prescribed airspace”. He/she ensures that the appropriate consultation with CASA and ASA is undertaken for all temporary infringements of the airports “prescribed airspace”, and NOTAM action is undertaken if required.

The Airside Standards Manager or delegate considers development and construction proposals of a permanent nature that may constitute “controlled activities” on Brisbane Airport or within the “prescribed airspace” extents.

He/she receives and processes applications for approval of “controlled activities” submitted in accordance with the *Airports (Protection of Airspace) Regulations*. In considering a proposal he/she consults with CASA, ASA, and the building authority concerned (usually Brisbane City Council).

He/she is responsible for collating any technical assessments of proposed “controlled activities” including input from CASA and ASA, and the notification of the activity to DIRDC with the consolidated technical assessment, within the required timeframes.

The Aerodrome Reporting Officers monitor the OLS, Type A chart take-off surfaces and the critical PANS-OPS surfaces during the daily serviceability inspections. They are required to detect and report new obstacles to the Airside Standard Manager or delegate.

Contact details for BAC staff mentioned in this procedure can be found on the Telephone Contact List at the front of the Manual.

References

CASRs

- 139.230 *Aerodrome technical inspections*
- 39.240 *Who may conduct aerodrome technical inspections?*
- 139.350 *Monitoring of airspace*
- 139.355 *Establishment of obstacle limitation surfaces*
- 139.360 *Notice of obstacles* 139.365 - *Structures 110 metres or more above ground level*
- 139.370 *Hazardous objects etc.*

MOS Part 139 – Aerodromes

Chapter 7 Obstacle Restriction and Limitation

Advisory Circulars

- AC 139-05(0) Guidelines for Conducting Plume Rise Assessments*
- AC 139-08(0) Reporting Tall Structures*
- Airports (Protection of Airspace) Regulations 1996*

Attachment L – Application by the Proponent - Crane Application



Proponent's Crane Application

FORM CA
Version 3.0

The Airports Act (1996) and the Airports (Protection of Airspace) Regulations apply to Brisbane Airport Airspace. Penalties apply for non approved Controlled Activities which penetrate airspace surfaces. Crane Companies should refer to [Crane Operational Plan \(BAC Drawing BAC1114110000001\)](#) as a guide to the sensitive areas associated with Brisbane Airport for Crane Operation.

A. Crane Location

Street Address

Street Number: Street Name:

Suburb: Nearest Street:

Co-ordinates

Northing: Easting:

Latitude (S): Longitude (E):

Attach a relevant Street Directory Page with location marked if location descriptions problematic and include with application

Crane Start Date: Crane Completion Date:

B. Contact Details

Company Name:

Contact person (Proponent):

Phone: Mobile:

Email:

Crane Operator / Driver Name:

Crane Operator / Driver Mobile Number:

1. Crane Operating Hours

1.1 Crane Start Date:

1.2 Crane Completion Date:

1.3 Crane Start time 24HR: hh: mm

1.4 Crane Completion time 24HR: hh: mm

1.5 Has a work approval been lodged with BAC Approvals: Yes No

A work approval is required prior to any works commencing. To obtain a work approval contact approvals@bne.com.au

2. Crane Details

2.1 Ground level (AHD) RL: m

2.2 Crane operating height (above ground level): m

2.3 Crane operating height (above AHD) item 2.1 + item 2.2 – in m AHD: m

2.4 Crane Boom Painted: Yes No Colour:

2.5 Hazard Lights at top of boom: Yes No if yes Colour: Flashing Occuring Steady N/A

2.6 Direct Communication with Crane Operator / Driver: Yes No

I, the Contractor/Representative for the above application hereby acknowledge that I understand my responsibilities in applying for this crane application and have attached all required documentation.

Office Use Only

CA:

Approved: Yes No Approving officer: Date:

Once this form is completed please submit with relevant documents to: craneapplication@bne.com.au, or print the completed form and post to PO BOX 61 Hamilton Central QLD 4007 Australia

Privacy Tick: TBA; Sunda voluptas. To il exediam, omnis, con experi odii occus sit quam fugia verro con erum, expella voluptur alios. Quis malora perro quae quana vel eictur sum quaeper accoibe. Quis accoia. Itatum fugiam exoia am, aliqui tamquibz eat rem re eiant quo conewoctor, omnis renhil itatus, ipsum cupizatus es necorfero verforibus acca quidat isqui sum nat.

Attachment M – Obstacle Limitation Surface (OLS)

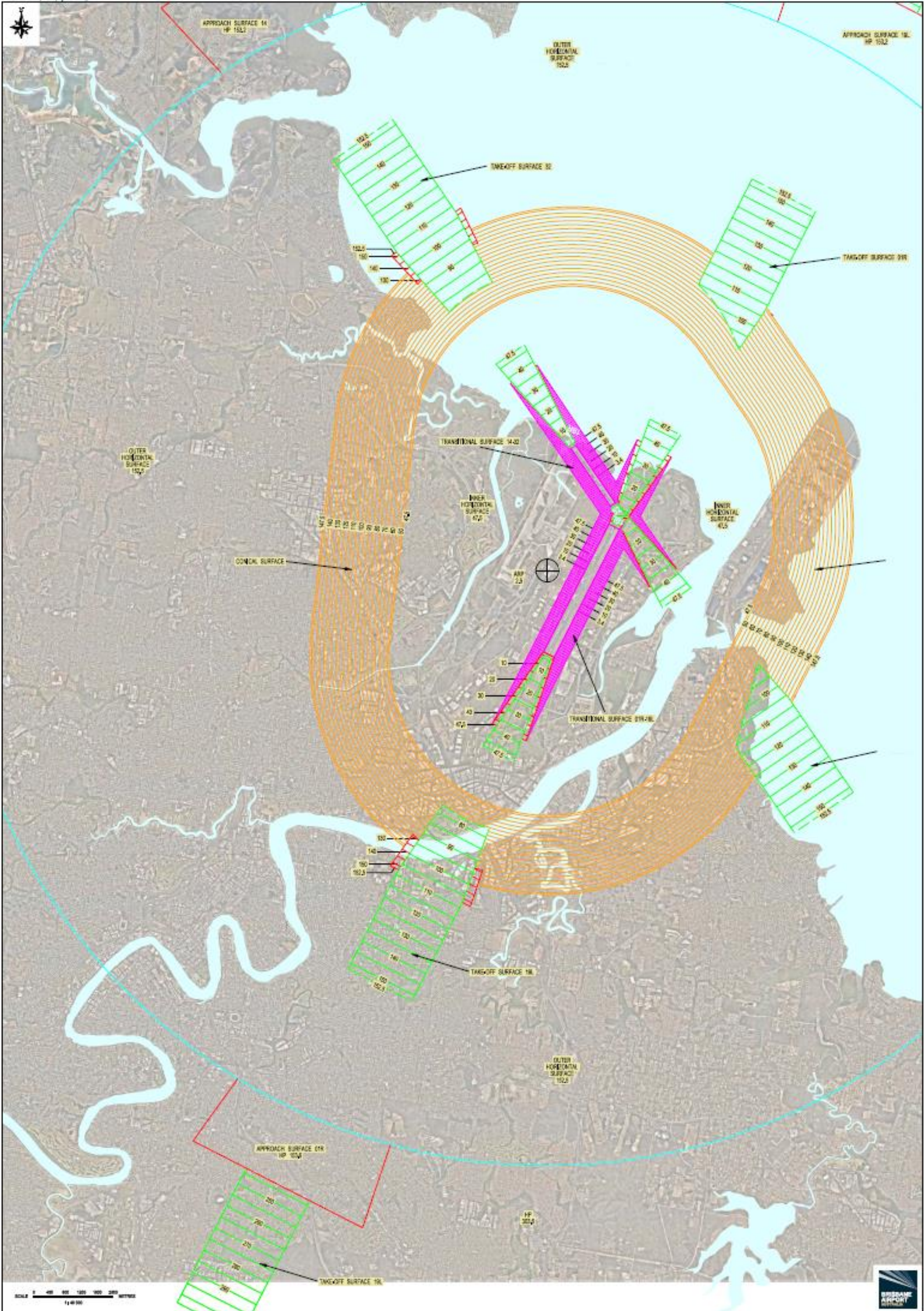

Attachment N – PANS OPS

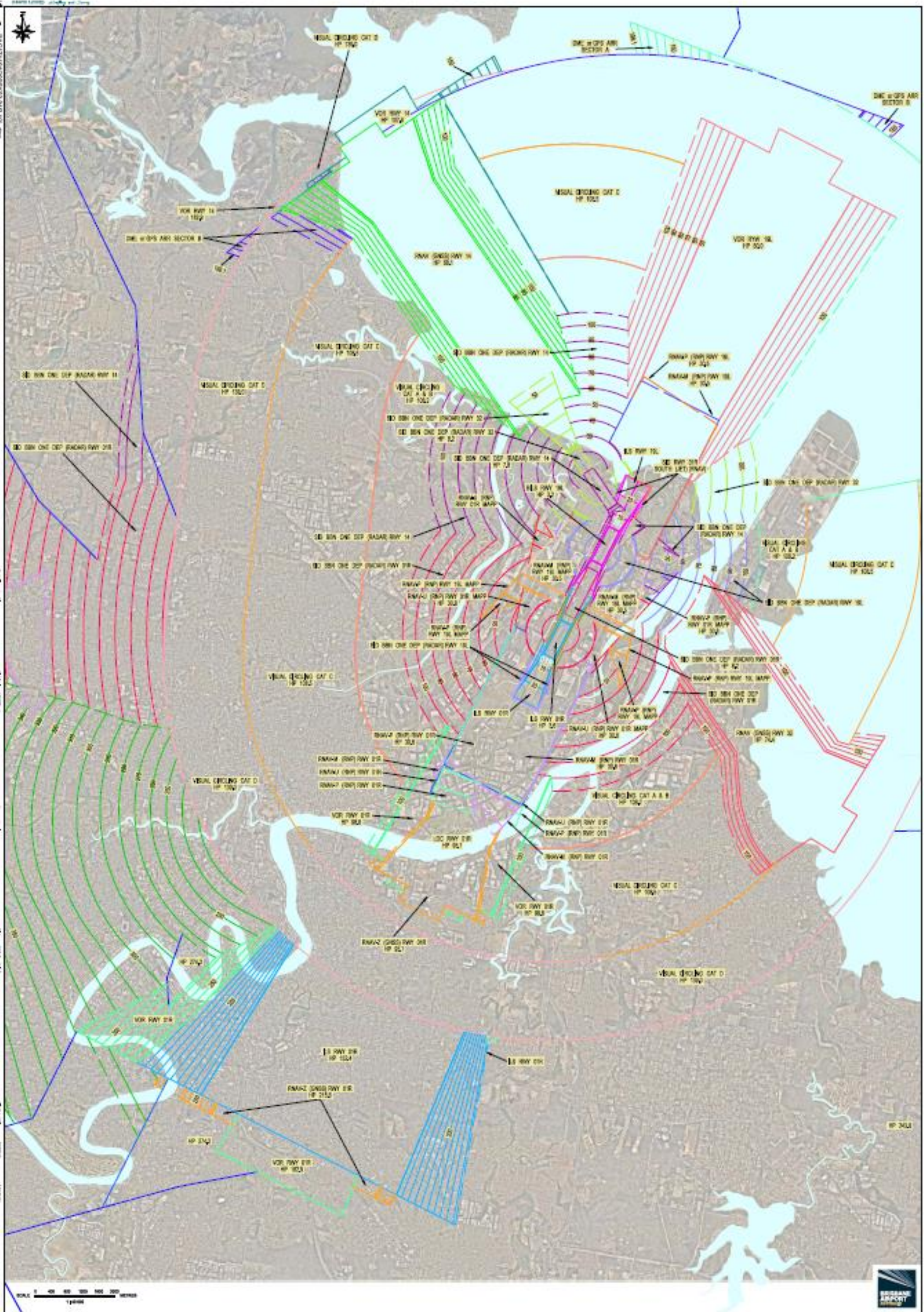

Attachment O – Operating Heights for Mobile Cranes

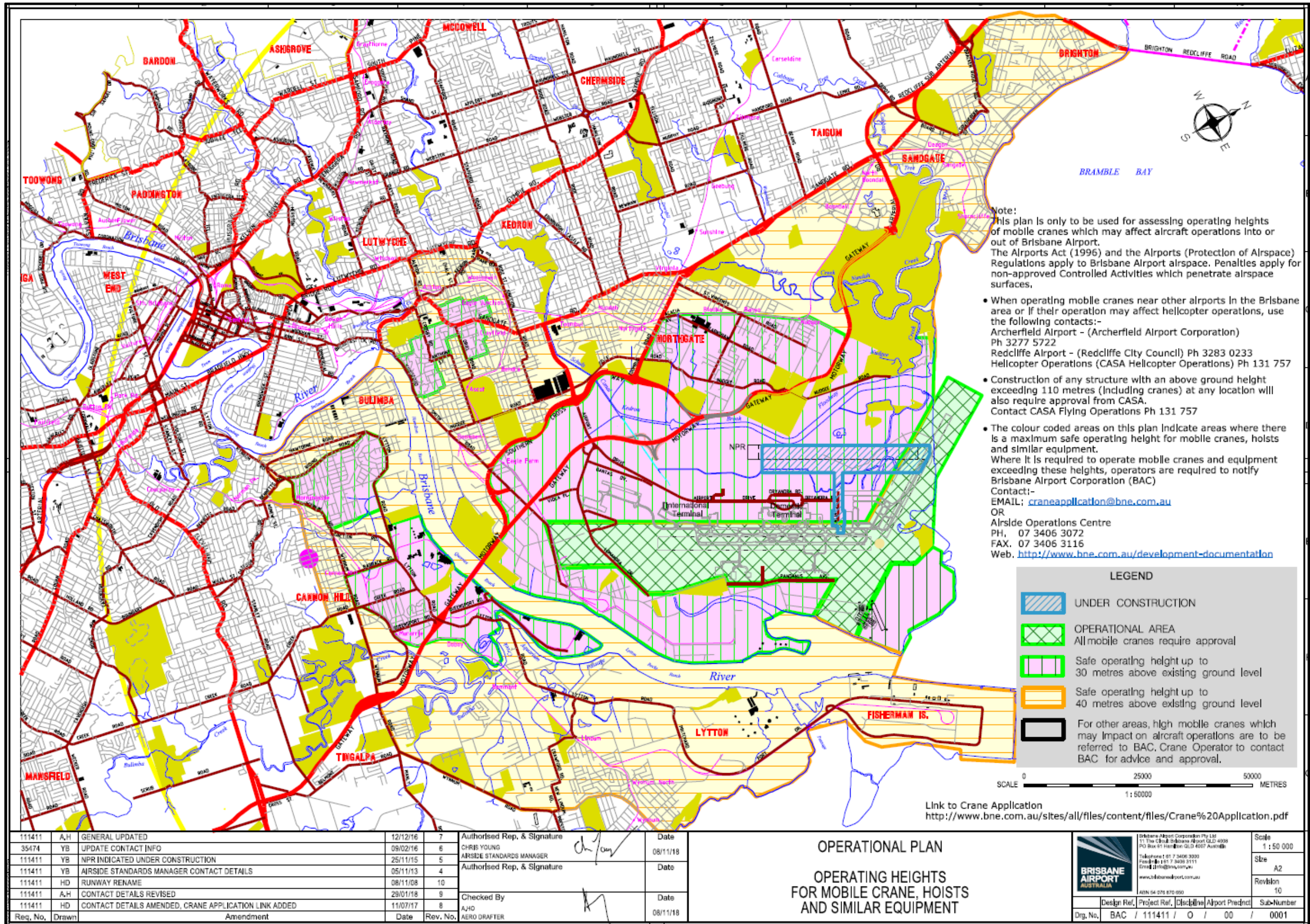

Attachment P – Maximum Lighting Intensities

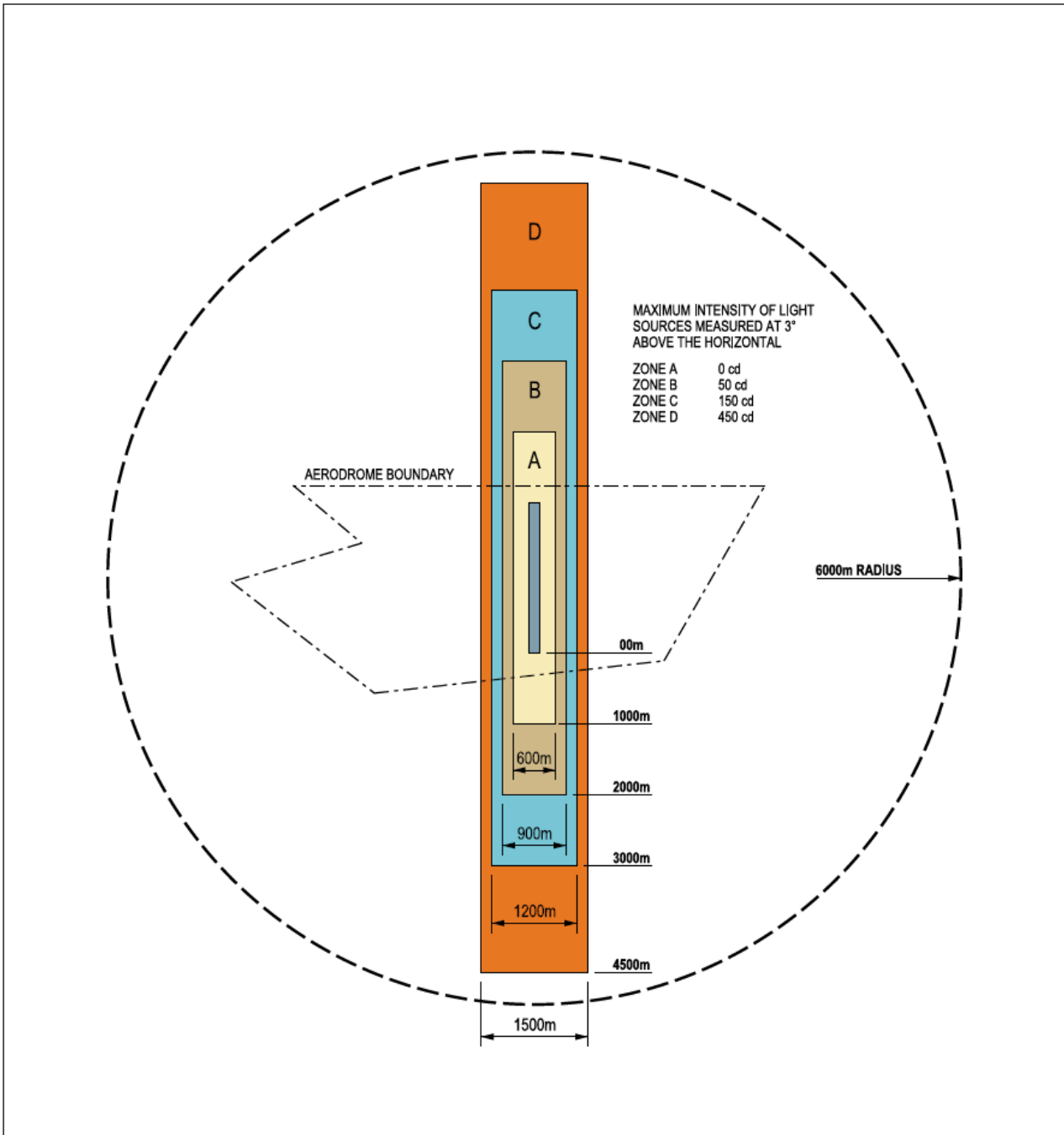

Attachment Q – Restricted Light Zones

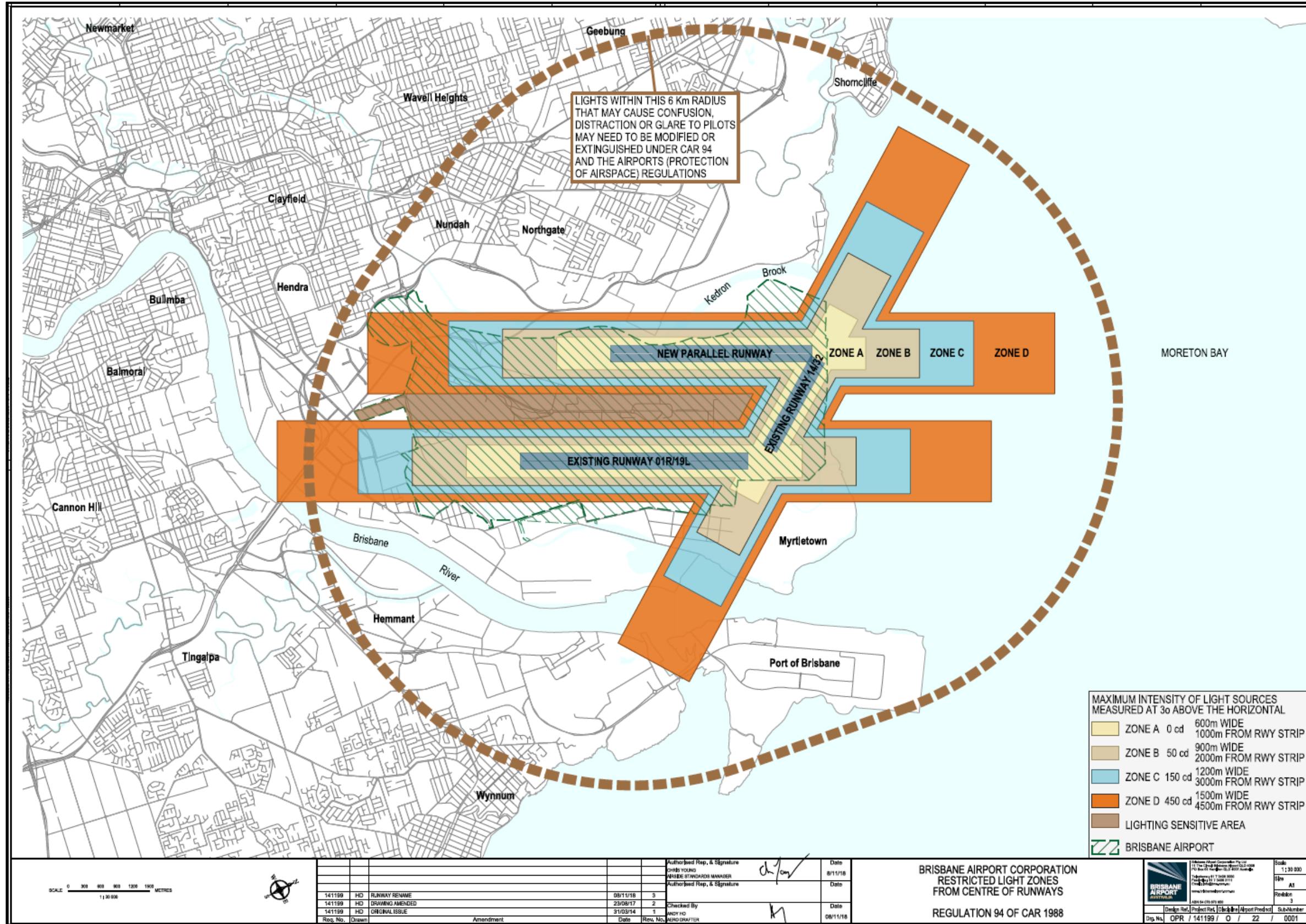

Part 2

Sub Section 2.12.10

Controlled Activities Application

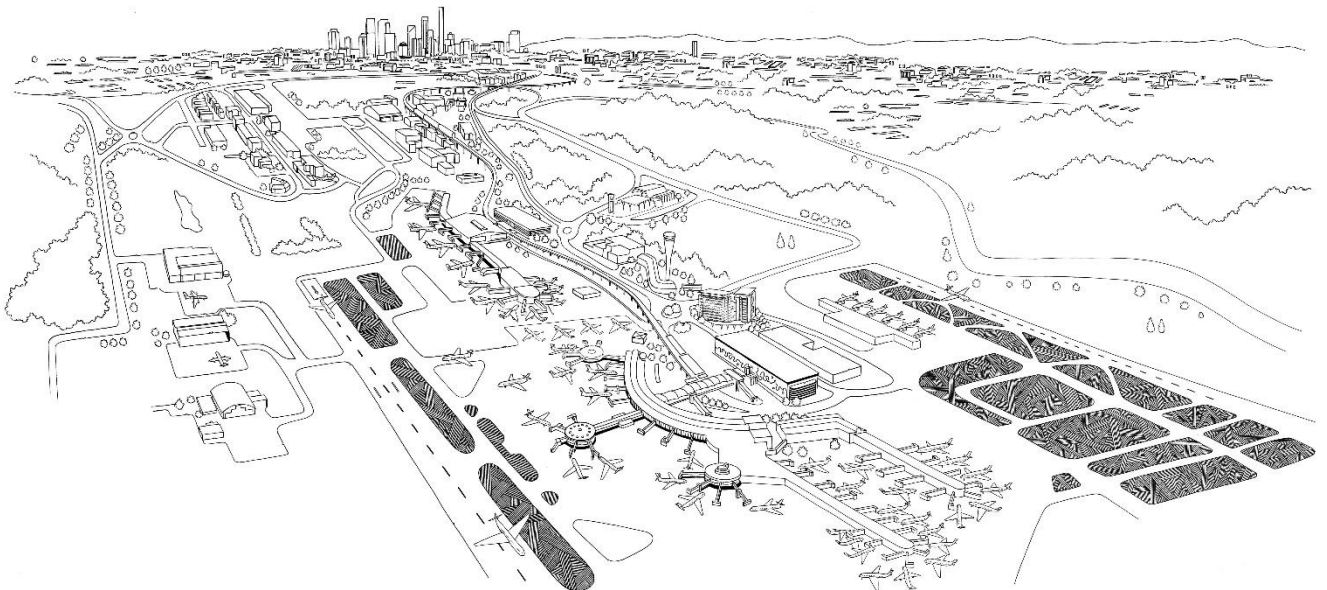

2.12.10 Sub Section – Controlled Activities Applications

2.12.10.1 Controlled activities

Part 12 of the Airports Act and the Airports (Protection of Airspace) Regulations provide for the protection of airspace at leased Federal airports. Under Section 182 of the Act, a controlled activity is an activity resulting in an intrusion of the airport's protected airspace (i.e. penetration of either the OLS or PANS-OPS surfaces). Controlled activities include the following:

- structures such as buildings, antennas and cranes; and
- Activities causing non-structural intrusions into the protected airspace of artificial light, reflected sunlight, air turbulence, smoke, dust, steam or other gases or particulate matter.

Controlled activities require approval under the Airports (Protection of Airspace) Regulations. Carrying out a controlled activity without approval is an offence under Section 183 of the Act punishable by a fine of up to 250 penalty units, currently equivalent to \$27,500.

2.12.10.2 How to use these guidelines

The guidelines cover the different requirements for addressing applications to carry out the following types of controlled activities:

- long term PANS-OPS intrusion (Section A);
- long term OLS intrusions (Section B);
- short term OLS or PANS-OPS intrusions – airport operator has authority to approve (Section C);
- very short term OLS or PANS-OPS intrusions – airport operator has authority to approve (Section D); and
- short term OLS or PANS-OPS intrusions – airport operator has no authority to approve (Section E).

2.12.10.3 Long term PANS-OPS intrusions

Upon receipt of the application, the airport operator determines that the application is long term, i.e. of more than 3 months duration, and that it would result in an intrusion of the protected PANS-OPS surface. No further assessment or consultation with other parties is required. Within 7 days of receiving the application, the airport operator notifies the applicant and, if appropriate, the local council, that the application cannot be approved.

2.12.10.4 Long term OLS intrusions

The airport operator assesses the application to determine:

- that the activity is of more than 3 months duration;
- the extent of intrusion, expressed in metres above the OLS; and
- the map coordinates of the proposed development/activity.

Within 7 days of receiving the application, the airport operator should send copies of the application, and the information identified in B1, to the relevant authorities, inviting them to assess/comment on the application. The relevant authorities are:

- CASA;
- Airservices Australia;
- the local council authority responsible for building approvals.

Within 21 days of receiving the application, the airport operator sends the application to the DIRDC, enclosing the assessments of CASA and Airservices and the airport operator company, and comments if any by the other relevant authorities. CASA's assessment is particularly important – DIRDC cannot make a decision on an application without it.

DIRDC is required to make a decision and notify the relevant parties within 28 days of DIRDC's receipt of the application. The relevant parties are:

- the applicant;
- the airport operator;
- CASA ;
- Airservices Australia;
- the local council authority responsible for building approvals; and
- in the case of a joint user airport, DIRDC or Department of Defence.

DIRDC may impose conditions on an approval based on recommendations from CASA, Airservices and the airport operator.

2.12.10.5 BAC Approval of Short Term Controlled Activities

The airport operator may approve short term controlled activities if it has accepted a delegation from DIRDC. Such a delegation enables the airport operator to approve short term intrusions of the OLS and, at its discretion, short term intrusions of the PANS-OPS surface.

After receiving an application, the airport operator determines:

- that the activity is of 3 months or less duration;
- that the activity will result in an intrusion of the OLS or PANS-OPS surface;
- the extent of intrusion, expressed in metres above the OLS or PANS-OPS surface; and
- the map coordinates of the development/activity.

Within 7 days of receiving the application, the airport operator provides the local CASA and Airservices offices with copies of the application, including information referred to under C2.

The airport operator waits on the assessments from CASA and, where appropriate, Airservices before making a decision on the application. It is mandatory for the airport operator to receive CASA's assessment before making a decision on an application. Airservices' assessment is not mandatory but may be significant in cases where an approval would result in a penetration of the PANS-OPS surface or a temporary redirection of flight paths.

The airport operator is required to make a decision on an application within 21 days of receiving the application. If the airport operator asks for additional information to use in the assessment of the application, then the airport operator has 21 days from receipt of that information to make a decision on the application and notify the relevant parties of that decision.

The airport operator's decision on a proposal can be either to approve, refuse or refer the application to DIRDC. If the decision is to refer to DIRDC, the airport operator must do so within 21 days of receiving the application and should send CASA's and Airservices' assessments with the application.

Any decision by the airport operator or any conditions which the airport operator imposes on a decision, must be made in the interests of the safety, efficiency or regularity of existing or future air transport operations into or out of the airport. Conditions imposed on approvals may relate to the way the controlled activity is carried out or to marking or lighting of the structure.

The airport operator may revoke an approval or change the conditions of an approval. Such a decision must also be made in the interests of the safety, efficiency or regularity of existing or future air transport operations into or out of the airport.

2.12.10.6 BAC Approval of Very Short Term Controlled Activities

Very short term controlled activities, e.g. an hour or less, could be approved on a less formal basis:

- the application could be informal, e.g. a telephone call by the applicant;

- informal consultation with CASA could be undertaken in the form of a telephone call, but written confirmation should be provided on the same day;
- if consultation with CASA is not possible within the available time, then the controlled activity can only be allowed to take place when the affected runway is not in operation;
- no other parties need be consulted; and
- the airport operator could approve the application subject to any conditions which it saw appropriate.

2.12.10.7 BAC Referred or Refused Short Term Controlled Activities

After receiving the application, the airport operator determines:

- that the activity is less than 3 months duration
- whether the application will result in a penetration of the OLS or PANS-OPS surface
- the extent of penetration, expressed in metres above the OLS or PANS-OPS surface
- the map coordinates of the development / activity.

Within 7 days of receiving the application, the airport operator provides the local CASA and Airservices offices with copies of the application, including information referred to under E1.

Within 21 days of receiving the application, the airport operator sends DIRDC the application, CASA's assessment and, where appropriate, Airservices' assessment. CASA's assessment is particularly important – DIRDC cannot make a decision on an application without it.

DIRDC is required to make a decision on an application within 28 days of its receipt of the application, and to notify the applicant, the airport operator, CASA and, where appropriate, Airservices of the decision.

DIRDC may impose conditions on an approval based on recommendations from CASA, Airservices or the airport operator.

Part 2

Sub Section 2.12.11

Development Assessment – Crane Operation Application

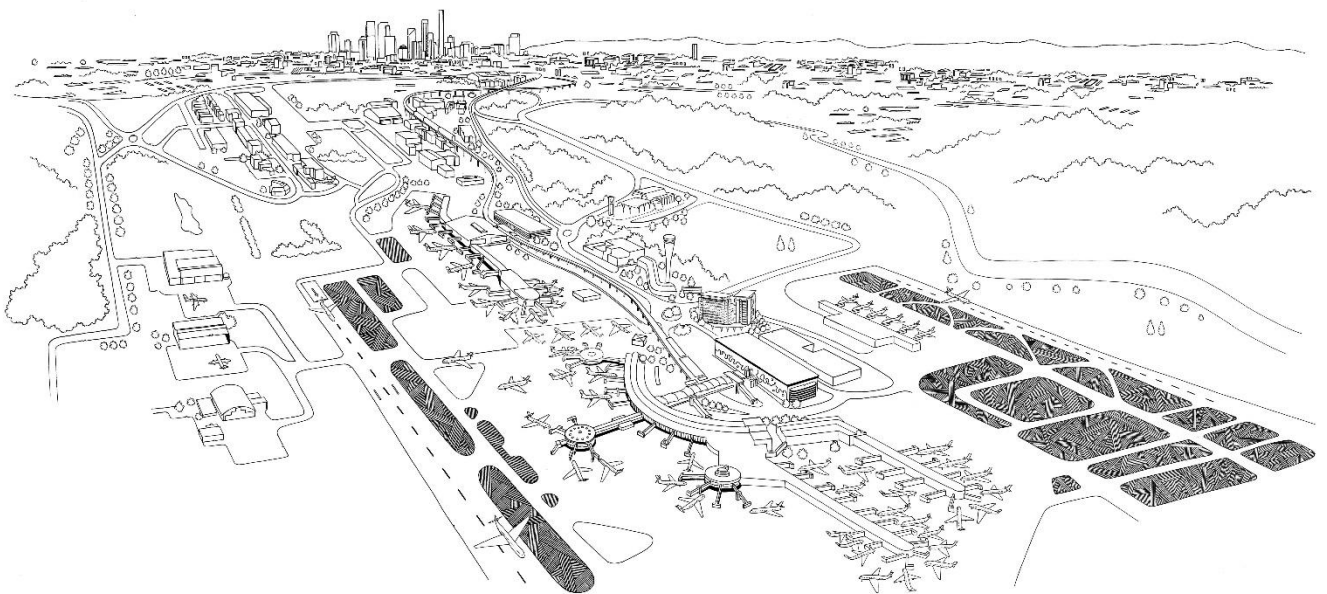

2.12.11 Sub Section – Crane Applications Overview

Under the provisions of the Airports Act 1996 and the Airports (Protection of Airspace) Regulations 1996, the Secretary of the DIRDC has delegated approval authority for Short-term Controlled Activities affecting Brisbane Airport's Prescribed Airspace to Brisbane Airport Corporation Pty Ltd (BAC).

Note – this form (Attachment J) is to be used for cranes and other temporary controlled activities but not permanent structures.

2.12.11.1 Definitions

Controlled Activity: any activity that results in intrusion into Brisbane Airport's Prescribed Airspace. It includes non-structural intrusions such as stack venting, and temporary intrusions such as cranes.

Prescribed Airspace: the airspace for Brisbane Airport ascertained in accordance with the Airports (Protection of Airspace) Regulations, and any additional airspace declared by the Secretary for DIRDC.

Short-term Controlled Activity: an activity that intrudes into Brisbane Airport's Prescribed Airspace that is not expected to continue for longer than 3 months

Note: Short-term controlled Activities are assessed against the Prescribed Airspace definition for the existing Brisbane Airport Runway infrastructure – Drawing FBP 93/0078 Sheet 2.

2.12.11.2 Timing of Submissions and Response

BAC must be given 21 days to assess an application for a short-term controlled activity, and must within that time seek advice from the Civil Aviation Safety Authority (CASA) and Airservices Australia (ASA).

Should the proponent not receive a response from BAC within the 21 day timeframe, then the application is deemed to be refused.

(BAC recognises the problems that a 21 day timeframe for approval may impose on the crane industry and will make every effort to facilitate an early response, however, the crane industry in turn must recognise the lead time required in seeking CASA and ASA advice.)

2.12.11.3 Penalties

The Airports (Protection of Airspace) Regulations has penalty provisions, including fines, for non-compliance with the requirements to notify BAC about a proposed Controlled Activity, or the carrying out of a Controlled Activity without approval. The DIRDC has indicated intent to apply these penalty provisions in the interests of aviation safety.

2.12.11.4 Background

Obstructions in the vicinity of an airport have the potential to create air safety hazards and to seriously limit the scope of aviation operations into and out of the airport. The impacts of individual obstacles may be relatively minor, but together a number of obstacles may seriously limit runway utilisation, cause airspace congestion and reduce the effective handling capacity of the airport. While the most critical areas of concern are the immediate approach and take-off areas, it is equally true that objects up to and beyond 20 kilometres from the airport and apparently unrelated to the runway alignment can cause problems for pilots approaching or departing an airport.

2.12.11.5 What is the law?

Part 12 of the Airports Act and the Airports (Protection of Airspace) Regulations establish a framework for the protection of airspace at and around airports. The Airports Act defines any activity resulting in an intrusion into an airport's protected airspace to be a "controlled activity", and requires that controlled activities cannot be carried out without approval. The Regulations provide for the DIRDC or the airport operator to approve applications to carry out controlled activities, and to impose conditions on an approval.

Carrying out a controlled activity without approval is an offence under Section 183 of the *Airports Act*, and is punishable by a fine of up to 250 penalty units, currently equivalent to \$27,500. It is an offence under Section 185 of the Act to contravene any conditions imposed on an approval. Under Section 186 of the Act it is an offence not to give information to the airport operator that is relevant to a proposed controlled activity.

2.12.11.6 What is Protected Airspace?

International standards have been adopted which define two sets of invisible surfaces above the ground around an airport. The airspace above these surfaces forms the airport's protected airspace. These two surfaces are the:

- obstacle Limitation Surface (OLS); and
- procedures for Air Navigational Services – Aircraft Operations (PANS-OPS) surface.

The OLS is generally the lowest surface and is designed to provide protection for aircraft flying into or out of the airport when the pilot is flying by sight. The PANS-OPS surface is generally above the OLS and is designed to safeguard an aircraft from collision with obstacles when the aircraft's flight may be guided solely by instruments, e.g. in conditions of poor visibility. For this reason, infringements of the PANS-OPS surface cannot usually be allowed.

2.12.11.7 What is a Controlled Activity?

Any activity that infringes an airport's protected airspace is called a **controlled activity**, and requires approval before it can go ahead. Controlled activities include the following:

- permanent structures such as buildings intruding into the protected airspace;
- temporary structures such as cranes intruding into the protected airspace; and
- any activities causing intrusions into the protected airspace by artificial light, reflected sunlight, air turbulence, smoke, dust, steam or other gases or particulate matter.

The Regulations differentiate between **short-term** and **long-term** controlled activities. Short term is less than 3 months while long term is longer than 3 months. The Regulations provide for the airport operator to approve **short-term** controlled activities, including PANS-OPS infringements, within 21 days of the airport operator receiving the application. They provide for DIRDC to approve **long-term** controlled activities, or **short-term** controlled activities referred to it by the airport operator, within 28 days of the airport operator referring the application to DIRDC. However, long term intrusions of the PANS-OPS surface are prohibited.

2.12.11.8 How do you know you need an approval?

The activity you intend carrying out will generally require an approval by State or local government authorities. Larger projects may require an Environment Impact Statement while most projects will require the issue of a building permit by the local council. Local councils in the vicinity of an airport's protected airspace are required to review all building and development applications they receive for any infringements of protected airspace, and to refer proposals to the airport operator if an infringement is likely to occur. The proponent will then need to apply through the airport operator for approval.

Airport operators are required to make charts of the OLS and PANS-OPS surfaces available to the public. In most cases these charts are also incorporated into the local council's planning information databases. To avoid any doubt, applicants (e.g... developers, builders and crane operators) should check with the airport operator or their local council at the earliest possible stage.

2.12.11.9 How do you apply- Controlled Activity?

Applications to carry out a controlled activity are to be made to the airport operator in writing. The information required in the application must include:

- the nature of the proposed controlled activity (building construction, crane operation etc.);
- its precise location (street directory grid references are suitable);
- if the controlled activity consists of the erection of a building or structure
- the proposed maximum height of the structure above Australian Height Datum including any antennae or towers); and
- the proposed maximum height of any temporary structure or equipment intended to be used in the erection of the structure; and

the purpose of the controlled activity.

2.12.11.10 Assessment of Applications

The airport operator will conduct the initial assessment of the application in terms of:

- whether the activity results in an intrusion into the OLS or PANS-OPS surface;
- the extent of the intrusion; and
- the precise location of the development or activity.

The airport operator is required to invite the following organisations to assess or comment on an application:

- the Civil Aviation Safety Authority (CASA – for an assessment of operational safety);
- Airservices Australia – for assessments of proposals resulting in a penetration of the PANS-OPS surface or temporary redirection of flight paths;
- the local council authority responsible for building approvals; and
- Department of Defence - in the case of joint-user airports.

For short term controlled activities, the airport operator is only required to seek assessments from CASA and Airservices.

2.12.11.11 Approval Process

The approval process varies depending upon the type of controlled activity:

- short-term controlled activities can be approved/refused by the airport operator after consultation with CASA and Airservices Australia, or referred by the airport to DIRDC for a decision;
- long-term controlled activities penetrating the OLS are referred by the airport to DIRDC for a decision after consultation with CASA, Airservices Australia and the relevant building authority; and
- long-term controlled activities penetrating the PANS-OPS airspace are not permitted, and the airport operator can notify the refusal of such controlled activities.

The Regulations require any decision by the airport operator to be made in the interests of the *safety, efficiency or regularity* of existing or future air transport operations into or out of the airport. An approval may be subject to conditions specified by the airport operator. These conditions may concern how the controlled activity is carried out (e.g... hours of operation of a crane), or may require the building or structure to be marked or lit in a certain way. These conditions must also be in the interests of the *safety, efficiency or regularity* of existing or future air transport operations.

The Regulations set the following timeframes for the approval of controlled activities:

- a decision on short term controlled activities is required to be made within 21 days of the airport operator receiving the application, unless the application is referred to DIRDC for a decision;
- a decision on long term controlled activities is required to be made by DIRDC within 28 days of DIRDC's receipt of the application; and
- If the airport operator, CASA, Airservices or DIRDC requires further information in respect of individual applications, the decision is to be made within 21 days (for short-term intrusions) or 28 days (for long-term intrusions) of the extra information being provided by the applicant.

2.12.11.12 The need for approval to operate cranes in protected airspace

Crane operations in the vicinity of an airport have the potential to create air safety hazards and to seriously limit the airport's operations. For this reason, crane operators are obliged by law to have their proposed operations assessed and approved under the *Airports (Protection of Airspace) Regulations*.

Carrying out a controlled activity without approval is an offence under Section 183 of the *Airports Act*, and is punishable by a fine of up to \$27,500. It is an offence under Section 185 of the Act to contravene any conditions imposed on an approval. It is an offence under Section 186 of the Act not to give information to the airport operator that is relevant to a proposed controlled activity.

2.12.11.13 How do you apply – Crane operations?

Applications to carry out crane operations are to be made in writing to the airport at least 28 days before the proposed activity. Applications forms will be available at the airport. The information required in the application must include:

- the nature of the proposed activity (i.e. crane operations);
- its precise location (street directory grid references can be used);
- the maximum height of the crane above Australian Height Datum (AHD);
- any marking or lighting installed on the crane; and
- proposed operating hours, and any other relevant information.

To avoid any doubt as to whether an approval is required, applicants should check with the airport operator at the earliest possible stage.

2.12.11.14 The approval

An approval may carry conditions relating to how the operation must be carried out. These conditions may include marking or lighting, the hours or weather conditions in which the crane can operate, or requirements to maintain contact with the airport during the operation.

2.12.11.15 Further Information

Further information on airspace protection, and application forms, are available from the airport operator

Part 2

Sub Section 2.12.12

Development Assessment - Permanent Structure

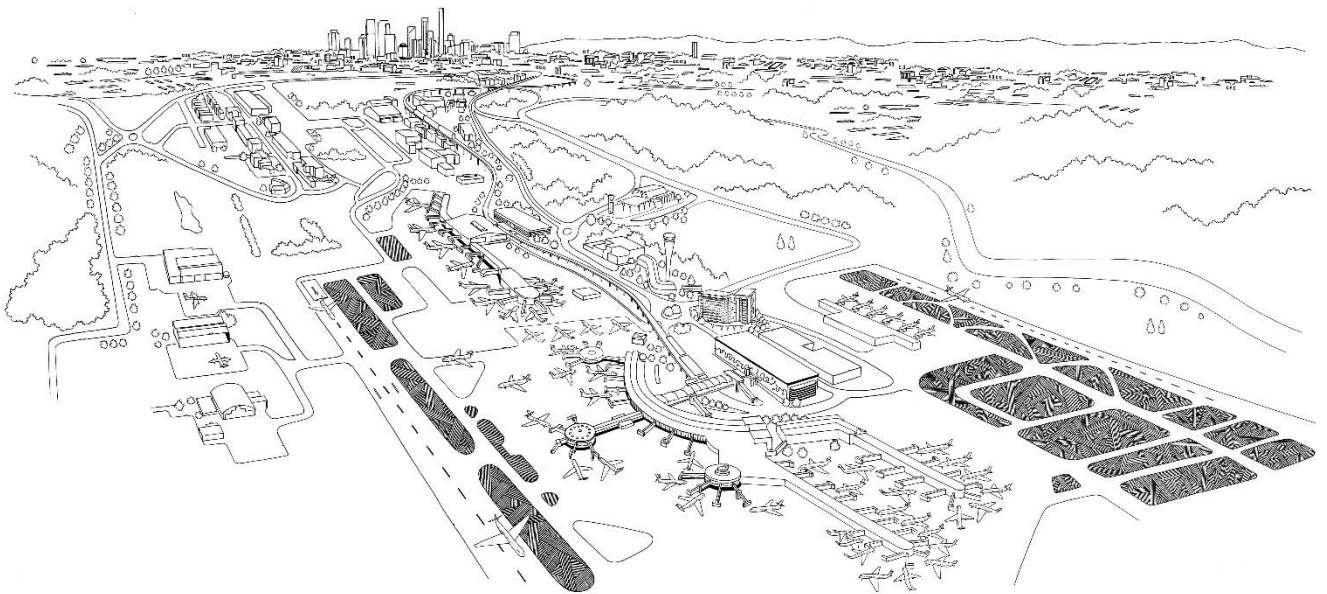

2.12.12 Sub Section – Permanent Structure Overview

Under the provisions of the *Airports Act 1996* and the *Airports (Protection of Airspace) Regulations 1996*, the Secretary of DIRDC has approval authority for Controlled Activities affecting Brisbane Airport's Prescribed Airspace.

Brisbane Airport Corporation Pty Ltd (BAC) is responsible for seeking submissions regarding the proposed Controlled Activity from the Civil Aviation Safety Authority (CASA), Airservices Australia (AsA), and the relevant Building Authority.

2.12.12.1 Definitions

Controlled Activity: any activity that results in intrusion into Brisbane Airport's Prescribed Airspace. It includes non-structural intrusions such as stack venting, and temporary intrusions such as cranes.

Prescribed Airspace: the airspace for Brisbane Airport ascertained in accordance with the *Airports (Protection of Airspace) Regulations*, and any additional airspace declared by the Secretary for DIRDC.

Building Authority: (a) for an activity on-airport – the Airport Building Controller (ABC).

(b) for an activity off-airport – Brisbane City Council (BCC). (In certain circumstances the Port of Brisbane Corporation or the State Government may be the Building Authority.)

2.12.12.2 Timing of Submissions and Response

An application for the Secretary's approval must be given to BAC at least **28 days** before the proponent's intended commencement of the Controlled Activity. The relevant Building Authority is also under an obligation to inform BAC of a proposed Controlled Activity. If the proposed Controlled Activity intrudes into PANS-Ops Airspace, then within 7 days, BAC must advise both the proponent and the relevant Building Authority that the application cannot be approved.

If, after BAC refers the application to DIRDC, the proponent does not receive a response from the Secretary of DIRDC within 28 days, then the application must be deemed to be refused.

2.12.12.3 Penalties

The *Airports (Protection of Airspace) Regulations* has penalty provisions, including fines, for non-compliance with the requirements to notify BAC about a proposed Controlled Activity, or the carrying out of a Controlled Activity without approval. DIRDC has indicated intent to apply these penalty provisions in the interests of aviation safety.

2.12.12.4 Lighting in the vicinity of aerodromes

Extracted from Manual of Standards Part 139 – Aerodromes

Section 9.21: Lighting in the Vicinity of Aerodromes

9.21.1 *Advice to Lighting Designers*

9.21.1.1 *This Section supersedes a paper of the same name dated July 1988 issued by the Civil Aviation Authority and referred to in Australian Standard AS 4282-1997, Control of the obtrusive effects of outdoor lighting.*

9.21.1A *Purpose of the Section*

9.21.1A.1 *This Section provides advice to those involved in the design or provision of lighting systems for use at or in the vicinity of an aerodrome. The intention is to minimise the potential hazard to aircraft operations from the lighting systems.*

9.21.1A.2 If an aerodrome operator becomes aware that a lighting installation is proposed to be or is being installed in the vicinity of the aerodrome, it is in the aerodrome's interest to make sure that the person responsible for the lighting system is made aware of the contents of this Section.

9.21.2 Legislative Background

9.21.2.1 The Civil Aviation Safety Authority (CASA) has the power through regulation 94 of the Civil Aviation Regulations 1988 (CAR 1988), to require lights which may cause confusion, distraction or glare to pilots in the air, to be extinguished or modified. Ground lights may cause confusion or distraction by reason of their colour, position, pattern or intensity of light emission above the horizontal plane. The text of regulation 94 is reproduced below for reference:

94 Dangerous lights

(1) Whenever any light is exhibited at or in the neighbourhood of an aerodrome, or in the neighbourhood of an air route or airway facility on an air route or airway, and the light is likely to endanger the safety of aircraft, whether by reason of glare, or by causing confusion with, or preventing clear reception of, the lights or signals prescribed in Part 13 or of air route or airway facilities provided under the Air Services Act 1995; CASA may authorise a notice to be served upon the owner of the place where the light is exhibited or upon the person having charge of the light directing that owner or person, within a reasonable time to be specified in the notice, to extinguish or to screen effectually the light and to refrain from exhibiting any similar light in the future.

(2) An owner or person on whom a notice is served under this regulation must comply with the directions contained in the notice.

Penalty: 25 penalty units.

(2A) An offence against sub regulation (2) is an offence of strict liability.

Note For strict liability, see section 6.1 of the Criminal Code.

(2B) It is a defence to a prosecution under sub regulation (2) if the defendant had a reasonable excuse.

Note A defendant bears an evidential burden in relation to the matter in sub regulation (2B) (see subsection 13.3 (3) of the Criminal Code).

(3) If any owner or person on whom a notice under this regulation is served fails, within the time specified in the notice, to extinguish or to screen effectually the light mentioned in the notice, CASA may authorise an officer, with such assistance as is necessary and reasonable, to enter the place where the light is and extinguish or screen the

light, and may recover the expenses incurred by CASA in so doing from the owner or person on whom the notice has been served.

9.21.3 General Requirement

9.21.3.1 Advice for the guidance of designers and installation contractors is provided for situations where lights are to be installed within a 6 km radius of a known aerodrome. Lights within this area fall into a category most likely to be subjected to the provisions of the regulation 94 of CAR 1988. Within this large area there exists a primary area which is divided into four light control zones: A, B, C and D. These zones reflect the degree of interference ground lights can cause as a pilot approaches to land.

9.21.3.2 The primary area is shown in Figure 9.21 -1. This drawing also nominates the intensity of light emission above which interference is likely. Lighting projects within this area should be closely examined to see they do not infringe the provision of regulation 94 of CAR 1988.

9.21.3.3 *The fact that a certain type of light fitting already exists in an area is not necessarily an indication that more lights of the same type can be added to the same area.*

9.21.3.4 *Even though a proposed installation is designed to comply with the zone intensities shown in Figure 9.21-1, designers are advised to consult with CASA as there may be overriding factors which require more restrictive controls to avoid conflict.*

9.21.4 *Light Fittings*

9.21.4.1 *Light fittings chosen for an installation should have their isocandela diagram examined to ensure the fitting will satisfy the zone requirements. In many cases the polar diagrams published by manufacturers do not show sufficient detail in the sector near the horizontal, and therefore careful reference should be made to the isocandela diagram.*

9.21.4.2 *For installations where the light fittings are selected because their graded light emission above horizontal conform with the zone requirement, no further modification is required.*

9.21.4.3 *For installations where the light fitting does not meet the zone requirements, then a screen should be fitted to limit the light emission to zero above the horizontal. The use of a screen to limit the light to zero above the horizontal is necessary to overcome problems associated with movement of the fitting in the wind or misalignment during maintenance.*

9.21.5 *Coloured Lights*

9.21.5.1 *Coloured lights are likely to cause conflict irrespective of their intensity as coloured lights are used to identify different aerodrome facilities. Proposals for coloured lights should be referred to the Authority for detailed guidance.*

9.21.6 *Information and Correspondence*

9.21.6.1 *Check with the nearest CASA office for likely effect on aircraft operations of proposed lighting in the vicinity of an aerodrome.*

References

CASRs

- 139.230 *Aerodrome technical inspections*
- 39.240 *Who may conduct aerodrome technical inspections?*
- 139.350 *Monitoring of airspace*
- 139.355 *Establishment of obstacle limitation surfaces*
- 139.360 *Notice of obstacles* 139.365 - *Structures 110 metres or more above ground level*
- 139.370 *Hazardous objects etc.*

MOS Part 139 – Aerodromes

Chapter 7 *Obstacle Restriction and Limitation*

Advisory Circulars

- AC 139-05(0) *Guidelines for Conducting Plume Rise Assessments*
- AC 139-08(0) *Reporting Tall Structures*

Airports (Protection of Airspace) Regulations 1996

Part 2

Section 13 – Disabled Aircraft Removal

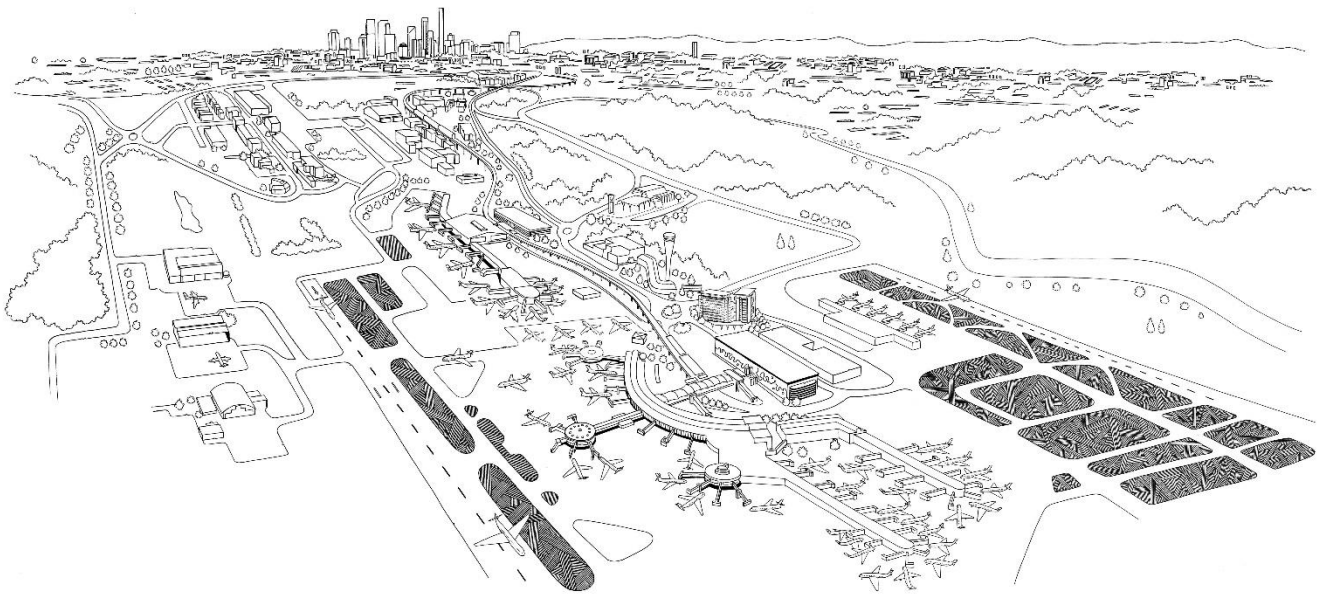

2.13 Disabled Aircraft Removal

To meet the requirements of Appendix 1 to CASR subparagraph 139.095(a) (ii) this section deals with the particulars of the procedures for removing an aircraft that is disabled on or near the movement area, including the following:

- (i) The roles of the aerodrome operator and the holder of the aircraft's certificate of registration;*
- (ii) The arrangements for telling the holder of the certificate of registration;
If necessary the holder of the certificate of registration will be identified through the aircraft register on the CASA website <http://casa.gov.au/casadata/register/index.htm>
Disabled aircraft removal activities will be documented.*
- (iii) The arrangements for liaising with air traffic control and the Australian Transport Safety Bureau and the NOF;*
- (iv) The arrangements for obtaining equipment and persons to remove the aircraft;*
- (v) The names and roles of the persons who are responsible for arranging for the removal of an aircraft which is disabled, and the telephone numbers for contacting them during and after working hours.*

These procedures are intended to deal only with disabled aircraft within the airport boundary. Recovery of aircraft following an accident off-airport does not directly involve BAC. Section 5 of the Aerodrome Emergency Plan (AEP) details in full the various phases of recovery.

2.13.1 Aerodrome Operator

An aircraft disabled on, or in close proximity to, the main runway at Brisbane Airport may close the runway or even the airport for an extended period.

This would result in diversions of other aircraft, flight delays or cancellations, loss of revenue to the airport and major inconvenience to the community. Arrangements need to be made to marshal and co-ordinate available airport and community resources so that the disabled aircraft is removed as quickly as possible, while having full regard to the statutory requirements and responsibilities of the authorities involved.

2.13.2 Recovery Coordination

The General Manager Operations or delegate has the overall responsibility for establishing a plan for removal of an aircraft which is disabled on or near the movement area at Brisbane Airport. He/she activates and chairs the Airport Recovery Coordinating Committee where the scale of response requires this. The committee members include BAC Operations, BAC Assets, Airline Representatives, ARFF, AFP (if required) and the Airlines nominated Ground Handling Agent.

Where removal is required following a crash or security incident, the General Manager Operations, or delegate activates the recovery procedure. He/she coordinates the BAC response. This includes liaison with the nominated Recovery Co-ordinator, the ATSB investigation team, CASA and Police as required, obtaining clearance to remove the aircraft so that normal serviceability and operations can be restored as soon as possible.

If recovery is delayed or progressing at an unacceptable rate, the General Manager Operations, or delegate may direct the owner to remove the disabled aircraft. If the owner fails to comply with the direction, BAC may remove the disabled aircraft at the owner's expense and risk. BAC accepts no responsibility for the removal of crashed or disabled aircraft on Brisbane Airport.

The General Manager Operations or delegate will convene a post recovery critique to review the effectiveness of the recovery procedures.



Note: Air Traffic Control (ATC) may activate the recovery procedure if they are first to become aware of a disabled aircraft.

The Airside Operations Manager or delegate refers to the checklist included in co-ordinating the BAC response during recovery of a disabled aircraft.

The Airside Standards Manager or delegate determines if a portion of a runway affected by a disabled aircraft can be made available for other operations. In such cases, he/she reports the revised declared distances to ATC and the Australian NOTAM Office and requests the raising of an appropriate NOTAM as described in Part 2, Section 4 (Aerodrome Reporting) of the Manual.

The Aerodrome Reporting Officer ensures that any unserviceable portions of the manoeuvring area are correctly marked to provide for safe aircraft operation on the remaining usable area. The Aerodrome Reporting Officers record any actions they take while the recovery procedure is activated.

2.13.3 Arrangements for Notifying Certificate of Registration (COR)

The General Manager Operations, or delegate will determine the COR holder from the pilot in command or the aircraft register and notify them accordingly.

2.13.4 Certificate of Registration Responsibilities

The airline or handling agent or the aircraft owner is required to arrange recovery of a disabled aircraft. Each airline or aircraft operator designates a Recovery Co-ordinator with full authority to liaise with the aircraft insurers and to make all technical and financial decisions required to remove a disabled aircraft.

When the aircraft owner/operator and/or handling agent is advised of a disabled aircraft he/she is required to initiate the recovery action immediately so that the aircraft and/or wreckage can be removed as soon as possible following its release by an appropriate authority. He/she arranges the removal of freight and/or baggage from the aircraft under QPS supervision, and if the flight originated from outside Australian territory, with the consent of a Customs Officer.

The Recovery Co-ordinator arranges for the prompt removal of the aircraft (and parts thereof) once this has been approved by an appropriate authority. Removal and disposal of fuel and other hazardous materials may be required prior to commencement and/or completion of the ATSB investigation, but in all cases prior to the aircraft's removal.

If the owner agrees that BAC should remove, or assist in the removal of, the aircraft, the Recovery Co-ordinator ensures that a standard Indemnity and Release document is completed first. This document will be provided by the BAC Company Secretariat.

2.13.5 Other Agencies

The Queensland Police Service (QPS) secures the aircraft and other property at the site pending hand-over of this responsibility to ATSB. The Aviation Rescue and Fire Fighting Service (ARFFS) remains on standby throughout to assist with operations as required, especially during de-fuelling of the aircraft.

ATC may direct the removal of an aircraft if Airservices considers it necessary in the interests of safety to do so, or to maintain the orderly flow of air traffic. In such cases BAC may be authorised to provide whatever assistance is considered "necessary and reasonable".

In addition, CASA may direct the removal of an aircraft if CASA considers it necessary in the interests of safety to do so, or to maintain the orderly flow of air traffic. In such cases BAC may be authorised to provide whatever assistance is considered "necessary and reasonable".

2.13.6 Arrangements for liaising with ATC & Australian Transport Safety Bureau

The Airside Standards Manager, or delegate will provide revised declared distances to ATC where required, where the runway is still able to be used, provided an obstacle free zone is maintained around the disabled aircraft.

If ATSB elects to conduct an on-scene investigation, a disabled aircraft cannot be removed from the movement area until authorised by the ATSB investigator(s). ATSB authorises the removal of a crashed aircraft when the initial investigation has been completed.

The designated Recovery Co-ordinator meets with the General Manager Operations, or delegate and ATSB to decide details of the recovery plan. BAC staff assists ATSB investigators if an on-site investigation is necessary.

2.13.7 Arrangements for Aircraft Removal Equipment

BAC, in conjunction with the designated Recovery Co-ordinator arranges all aspects of the recovery including human resources and equipment required, insurance company releases and media liaison.

2.13.8 Operations Response Checklist

BAC Airport Operations personnel are required to:

1. arrange for security of the accident site in co-ordination with ATSB;
2. if appropriate, arrange for a displaced threshold for landing aircraft and calculate/notify revised declared distances;
3. if appropriate, establish a Command Post at the site;
4. inspect all areas prior to resumption of normal operations;
5. return affected portions of the airport to operation as expeditiously as possible after ensuring that access to the incident area has been secured and associated taxiways and runways are in good operational condition and free of debris and damage;
6. co-ordinate all aspects of the removal effort;
7. convene a meeting with the Recovery Co-ordinator, ATSB investigator and where necessary representatives from CASA and AsA, oil company and recovery equipment company;
8. keep a chronological record of meetings and recovery operations;
9. determine recovery equipment and manpower needs;
10. establish suitable access routes to and from recovery area;
11. determine, in consultation with the airline, if the aircraft needs to be de-fuelled;
12. monitor weather conditions, particularly when crane lifting or air bag operations are planned;
13. arrange lighting to site if necessary;
14. determine whether runway obstacle surface clearance limits are likely to be infringed during recovery operation;
15. if excavations are necessary obtain a clearance from the Airport Lighting Section and Engineering Services Section in relation to underground services;
16. arrange necessary surface restorations;
17. convene a post recovery operation critique; and
18. Attend post recovery.



2.13.9 Sources of Aircraft Recovery Equipment

Qantas Airways Ltd, Sydney (Specialised aircraft recovery kit)

Duty Terminal Managers	ITB	3307 9109
	DTB	3867 3405
Maintenance Manager	Office:	3867 3300
MANAGER AIRCRAFT CUSTOMER	Home:	3268 1504
SERVICES	Mobile:	0418 238 957 (24/7) – 05:00am -23:00

Admin Office - Qantas Hangar 2, (BNE02/G), Cnr Priors Road & Pandanus Avenue, Pinkenba.

Boom Logistics

184 Curtin Avenue West Eagle Farm	(07) 3868 6888
Call Center	1300 362 666

Coates Hire

985 Kingsford Smith Drive	(07) 3623 3600
171 Abbotsford Road	(07) 3434 0960
Business Hours	131 552

Barnes Towing and Salvage

19 Suscatand Street Rocklea 24/7	(07) 3274 1111
----------------------------------	----------------

RAAF Base Amberley

All hours - Main Switchboard	1300 333 362
------------------------------	--------------

2.13.10 Roles and Responsibilities

The General Manager Operations, or delegate co-ordinates the removal of a disabled aircraft, and liaises with the airline or aircraft operator and the ATSB. The Aerodrome Reporting Officer ensures that any unserviceable portions of the manoeuvring area are correctly marked.

The Airside Standards Manager or delegate calculates revised declared distances if operational considerations require it and reports them to ATC and to the Australian NOTAM Office for the raising of an appropriate NOTAM. The telephone numbers of BAC staff nominated in this procedure can be found on the Telephone Contact List at the front of the Manual.



References

CASR

139.210 *Aerodrome Emergency Plan*

MOS Part 139 – Aerodromes

Section 10.7.3 Disabled Aircraft Removal

Airservices Regulations

Regulation 3.04 Removal of safety hazards

Civil Aviation Regulations 1988

Regulation 293 Removal of aircraft from movement area

Part 2

Section 14 - Handling of Hazardous Materials

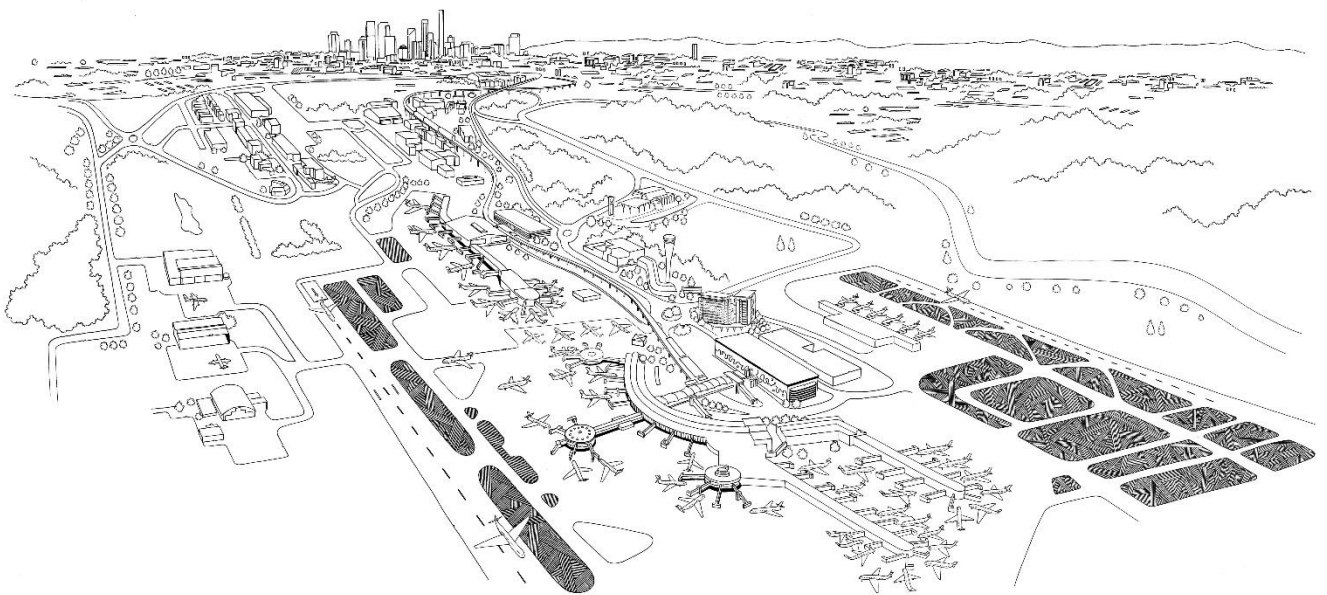

2.14 Handling of Hazardous Materials

To meet the requirements of Appendix 1 to CASR subparagraph 139.095(a) (ii) this section deals with particulars of the procedures for the safe handling of hazardous materials on the aerodrome, including the following:

- (i) The names, telephone numbers and roles of the persons who are to receive and handle hazardous materials;
- (ii) The arrangements for special areas on the aerodrome to be set up for the storage of flammable liquids (including aviation fuels) and any other hazardous materials;

Details of storage areas are recorded in this section

- (iii) The methods to be followed for the delivery, storage, dispensing and handling of these materials.

Include reference to applicable Australian standards

The *Brisbane Airport Environment Strategy* is published and distributed independently of the Aerodrome Manual. It specifies measures for monitoring, controlling, preventing or reducing environmental impacts associated with airport operations.

2.14.1 Contacts for Receiving and Handling Hazardous Materials

The names, telephone numbers and roles of the persons who are to receive and handle hazardous materials are outlined below.

Dangerous goods consigning is handled by:

EPM – EnLog Pacific Management Pty Ltd 07 3260 2366 (24 hours)

Aviation Fuels are handled by:

JUHI - Joint Users Hydrant Installation 07 3860 4644 (24 hours)

The arrangements for special areas on the aerodrome to be set up for the storage of flammable liquids (including aviation fuels) and any other hazardous materials are outlined below.

Aviation Gasoline (AVGAS) and JET A-1 are the main aircraft fuels stored and used on Brisbane Airport. All bulk aircraft fuel supplied is stored in fuel tanks or tankers within fuel farms designated for that purpose by BAC. These are located in proximity to the old International Terminal and in the main JUHI facility located at Hakea Street.

BAC authorises each flammable materials store constructed on the airport. Generally these stores are associated with aircraft maintenance facilities and contain materials such as cleaning spirits, paints, thinners and small amounts of aviation fuel. They must be designed and maintained in accordance with relevant Australian standards.

No other hazardous materials covered by these procedures are stored permanently on the airport. Temporary storage pending consignment by air is the responsibility of the freight forwarder.

The methods to be followed for delivery, storage, dispensing and handling of these materials are outlined below.

2.14.2 General arrangements

The General Manager Operations or delegate specifies procedures for the safe storage and handling of hazardous materials to avoid danger to aircraft or members of the public.

An Aerodrome Reporting Officer monitors the safe loading and unloading of hazardous materials, designates appropriate areas on the movement area for these purposes, and ensures the implementation of these procedures. BAC does not act as a handling agent for hazardous materials. The carrier or facility operator has sole responsibility for such materials which are held, stored or used at Brisbane Airport.

The facility operator is required to have sufficient trained personnel available to handle and store these materials safely at all times. Each organisation involved in air freighting hazardous materials is required to adopt correct procedures for packaging, storage and their transfer between aircraft and landside facilities and comply with the provisions of the *IATA Dangerous Goods Regulations*.

Airport tenants using and storing hazardous materials on site are required to comply with applicable legislation and Australian standards, and have copies of the relevant material safety data sheet (MSDS) available for reference by their staff.

Airlines warn and screen passengers in regard to the unlawful carriage of hazardous materials on aircraft.

2.14.3 Fire protection

All hazardous material stores are required to have immediate response firefighting facilities installed which comply with the relevant standards.

Smoking, open flames, or the lighting of cigarettes, cigars, pipes, matches etc. are prohibited within 15 m of a fuelling facility or flammable/hazardous material store.

Smoking airside at any time is prohibited under Federal Law.

Fire extinguishers and fire protection equipment installed for the protection of hazardous articles and materials is not to be tampered with or used for any other purpose, and is to be maintained in accordance with the applicable Australian Standards.

2.14.4 Petrochemicals

JET A-1 is dispensed to aircraft directly from tanker or the in-ground hydrant installation. AVGAS is dispensed to aircraft from tanker. Fuel tankers carrying aviation fuel are to be parked in designated areas only. Tankers are not to be parked for extended periods on aircraft aprons or adjacent passenger terminals unless specifically authorised to do so.

Mobile tankers are required to meet the construction requirements of Australian Standard AS 2809. Flammable liquids must be handled in accordance with CAO 20.9 and the Australian Standard AS 1940-1988: Flammable and Combustible Liquids Code.

If a fuel spill occurs at an aircraft fuel dispensing device or fuel storage facility, fuelling operations must stop immediately. The ARFF and duty Aerodrome Reporting Officer are notified. Each Aerodrome Reporting Officers vehicle carries supplies of dispersant/absorbent for the immediate treatment of a fuel/oil spill. Reserves are held at Airside Operations Centre. The ARFF hose down the affected area following treatment of the spill.

Tenants who generate petrochemical wastes and associated hazardous waste materials are required to provide metal containers with self-closing lids for their storage and remove such waste from the airport regularly.

2.14.5 Corrosive and radioactive materials

Where the General Manager Operations, or delegate is advised or becomes aware of the need to transfer other hazardous materials of a corrosive, radioactive nature, he/she determines specific requirements in conjunction with the Airside Operations Manager, or delegate. They consider the following criteria when allocating an area for the procedure:

- drainage flow;
- clearance distances from other aircraft, buildings and equipment;
- possible effects of spillage and drifting vapours if containers are punctured; and
- possible effects to pavement surfaces and other adjacent facilities.

2.14.6 Explosives

Storage of explosives on Brisbane Airport is not permitted, unless specifically authorised.

The loading and unloading of explosives to and from aircraft is permitted only in areas dedicated for such operations. The preferred location for such operations is taxiway Lima between taxiway Papa-North and taxiway Papa-South.

The aircraft operator and/or freight handler must have the approval of the BAC General Manager Operations, or delegate and CASA Inspector Flying Operations for all explosives transport operations through Brisbane Airport.

BAC requires at least four days' notice prior to any explosives transfer planned through Brisbane Airport.

Whenever explosives are transported by air through Brisbane Airport, the General Manager Operations, or delegate ensures that they are handled in accordance with the requirements set out in Attachment A.

2.14.7 Brisbane Airport Environment Strategy

The *Brisbane Airport Environment Strategy (AES)* describes specific measures adopted at Brisbane Airport to implement the environmental obligations set out in the *Airports Act 1996* and its associated regulations. This includes contingency plans to guide actions to be taken in the event of an environmental accident/incident. In the case of a hazardous materials incident these supplement the procedures which are implemented through the Brisbane Airport AEP.

The Managing Director/CEO has overall responsibility for implementing the AES.

BAC's Environment & Sustainability Manager, or delegate develops specific action plans to ensure that BAC, its tenants and contractors are complying with relevant legislation and Australian standards.

2.14.8 Hazardous materials incidents

A hazardous materials incident may be nothing more than a minor fuel spill. Even so, Aerodrome Reporting Officers are required to log and report any occurrence of this kind to the Airside Operations Team Leader. If necessary he/she will activate the Hazardous Materials Emergency Plan (as outlined in the Brisbane Airport Emergency Plan).

The Aerodrome Reporting Officers routinely monitor for fuel, oil and sewage spills on aprons as part of their daily serviceability inspections. In particular they will regularly check each bay on the RPT aprons and report any spills that require clean up, or are significant enough to require parking bay closure.

The management of incidents involving hazardous materials is vested in the Aviation Rescue and Fire Fighting (ARFF) service which has experience and equipment to deal with all situations. Minor incidents, such as a small fuel spill, are generally handled by the airline or fuel supplier concerned, with the ARFF providing assistance as required. The response to major incidents is co-ordinated in accordance with the Brisbane Airport Emergency Plan.

Aerodrome Reporting Officers record details of all hazardous materials incidents that come to their attention. All fuel/oil and/or other spills regardless of extent must be reported to BAC.

The Aerodrome Reporting Officer formally reports all fuel spills - large or small.

The Airside Operations Manager or delegate maintains a computer based database containing details of all fuel spills. All fuel spills reported are recorded in this system by Aerodrome Reporting Officers.

2.14.9 Requirements for Handling Explosives

Safety Distance (metres) between explosive laden aircraft and other aerodrome facilities

Net Explosive Quantity (NEQ) (KG)	Hazard Division 1.1, 1.2 and 1.5		Hazard Division 1.3 Propellant and non-propellant	
	Passenger Terminals & Runways	Other inhabited buildings, taxiways and public roads	Passenger Terminals & Runways	Other inhabited buildings, taxiways and public roads
25	270	180	50	30
200	270	180	60	40
500	270	180	80	50
1000	270	180	90	60
2000	270	180	100	70
3000	300	200	110	80
5000	380	250	120	90
10000	480	320	150	120
20000	600	400	200	150

Notes:

- Explosive laden aircraft should not be parked, loaded or unloaded in front of glass constructed passenger terminals. Where this is unavoidable, the recommended safety distance should be doubled;
- for NEQ less than 25kg, safety distances less than those recommended above may be used by aerodrome operators with due consideration for safety;
- hazard Divisions 1.4 and 1.6 explosives may be handled without the need for safety distances;
- safety distances recommended in the table apply to active runways, taxiways and public roads;
- the separation distance for intermediate quantities of explosives may be obtained by interpolation; and
- definition of Hazard Divisions 1.1, 1.2, 1.3 and 1.5 is contained in *ICAO Technical Instructions for the Safe Transport of Dangerous Goods*. Details of the hazard divisions of the explosives transported should be made available by the consignor/consignee of the explosives or the aircraft operator carrying the explosives.

2.14.10 Hazard Division

When more than two Hazard Divisions (HD) are present in any load, two HD shall be considered in determining a resultant HD which should then be considered with the next HD and so on until all HD present in the load have been considered, as shown in the examples below:

Example 1

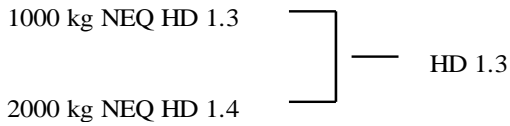

Example 2

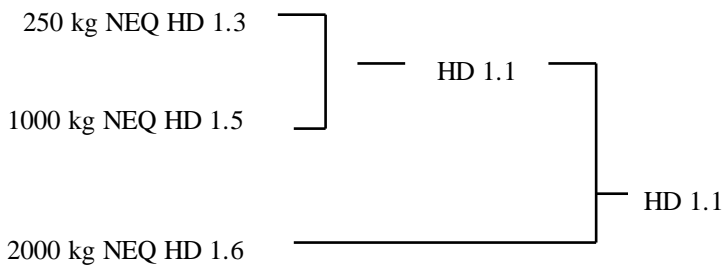

Example 3

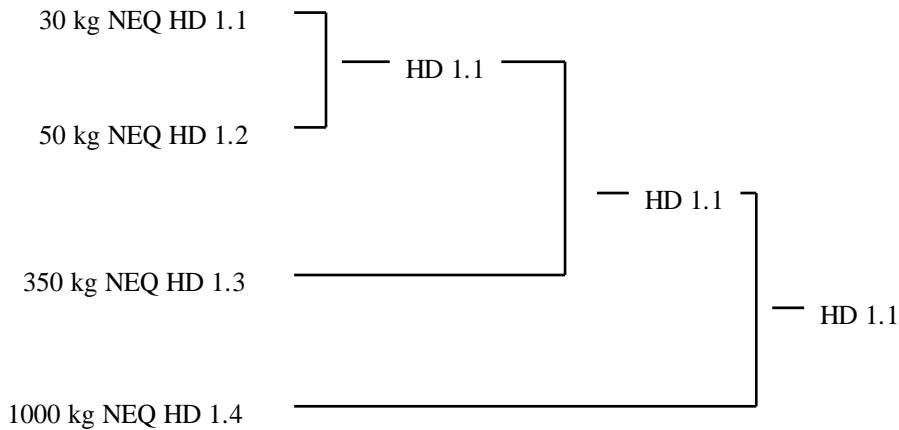



2.14.11 Contacts for handling hazardous materials

The following BAC personnel can be contacted by telephone during normal business hours on numbers listed at the front of this Manual:

- Airside Operations Manager;
- Airside Standards Manager;
- Airside Standards & Works Coordinator;
- Airside Safety Systems Manager;
- Airside Coordination Manager;
- Terminal coordinators; and
- Airside Operations Centre (24 hrs.).

Personnel from other organisations can be contacted as follows:

- | | |
|--|------------------------------|
| • Duty Fire Officer - AsA (24 hrs.) | 07 3866 3591 or 07 3866 3503 |
| • Australian Transport Safety Bureau | 07 3831 0628 or 1800 011 034 |
| • Inspector (Flying Operations) – CASA | 131 757 |
| • Dangerous Goods Inspector – CASA | 131 757 |

If after hours/emergency callout is required, these personnel can be contacted through the Duty Airside Operations Team Leader/Officer, Airside Operations Centre (3406 3072), who has the current callout numbers.

References

CAOs

CAO 20.9 *Air Service Operations – Precautions in Refuelling, Engine and Ground Radar Operations*

CAAP 89I-1(2) *Safety Distances for Explosive Laden Aircraft*

Part 2

Section 15 - Protection of Radar and Navigational Aids

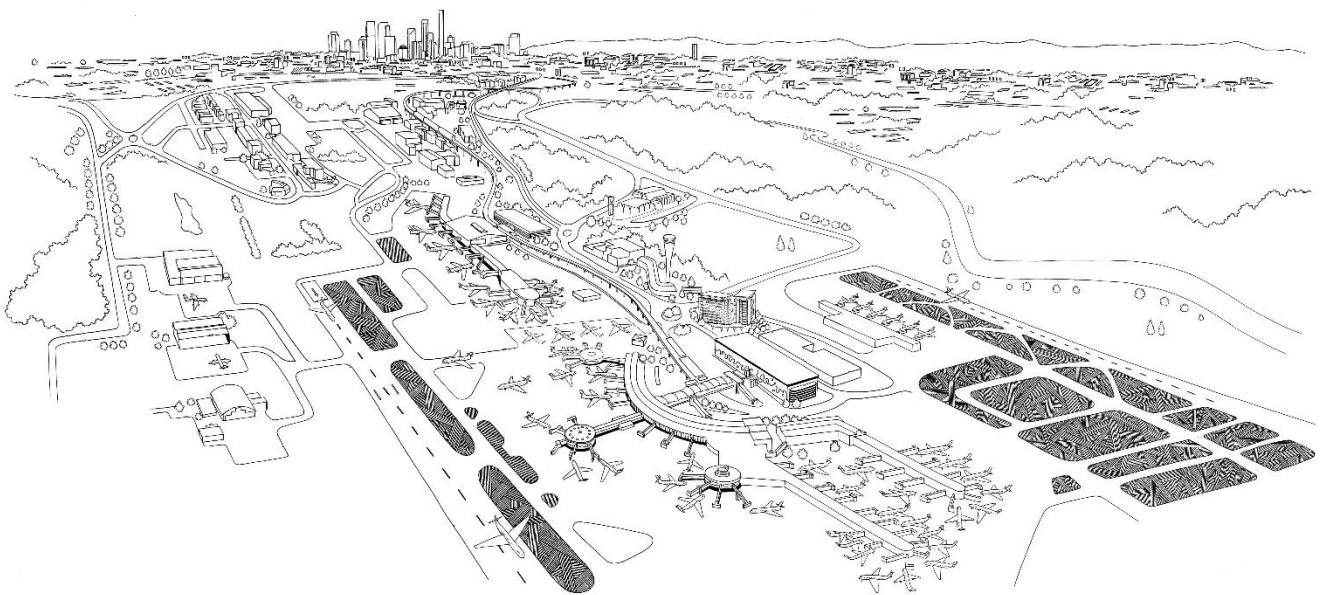

2.15 Protection of Radar and Nav aids

To meet the requirements of Appendix 1 to CASR subparagraph 139.095(a) (ii) this section deals with the particulars of the procedures for protection of radar and navigational aids located on the aerodrome to ensure that their performance will not be degraded, including details of the following:

- (i) The arrangements for the control of activities near radar and navigational aid installations;*
- (ii) The arrangements, made in consultation with the provider of the navigational aid installation, for the supply and installation of signs warning of hazardous microwave radiation;*
- (iii) The arrangements for ground maintenance near these installations.*

2.15.1 Arrangements for the control of Nav aids

Details of navigational aids provided at Brisbane Airport are included in AIP-ERSA.

2.15.2 Need to Protect Nav aids

Pilots may utilise aerodrome based nav aids for en-route navigation or to make an instrument approach to the aerodrome. Unplanned interruptions to or degradation of, the ground signal need to be avoided in the interests of safety of aircraft operations.

2.15.3 Access restriction

Airservices Australia is responsible for the physical protection of its nav aids, including appropriate fencing and the erection of warning signs to restrict entry to each site.

Access to the nav aids and/or nav aid sites for routine maintenance is made available at Air Traffic Control discretion. Airside access by contractors is subject to the provisions of Part 2, Section 5 (Unauthorised Entry to Aerodrome) of the Manual. Restricted areas around the aids are marked and no BAC staff or contractors may enter within these restricted areas unless by prior arrangement with Airservices ATC.

2.15.4 Nav aids Maintenance

ASA arranges technical maintenance of its nav aids located at Brisbane Airport either by using its own resources or by outside contract. The Electrical Services Assets Manager ensures protection of control cables and electricity supply to each site.

2.15.5 Arrangements for New Works

In siting new facilities, BAC will comply with the clearance requirements included in Chapter 11 of the *Manual of Standards Part 139 – Aerodromes* (issued by CASA under the *Civil Aviation Safety Regulations 1998*). BAC also provides protection by restricting works near feeder cables to the individual nav aid sites.

2.15.6 Arrangements of Warning Signs

Airservices Australia is responsible for the notification to BAC of Critical Areas with regards to navigation equipment areas; BAC is responsible for the erection of warning signs to restrict entry to warn of hazardous microwave radiation.



2.15.7 Arrangements for Ground Maintenance

The General Manager Operations or delegate ensures that ASA is advised of any works proposals which may affect the nav aids on Brisbane Airport, including any cables associated with those facilities.

The Airside Maintenance Coordinator arranges the mowing of the defined areas associated with the navigation aids and the maintenance of access roads.

References

MOS Part 139 – Aerodromes

Section 10.16 Maintenance around Navigational Aids

Chapter 11 Standards for Other Aerodrome Facilities

Part 2

Section 16 - Low Visibility Operations

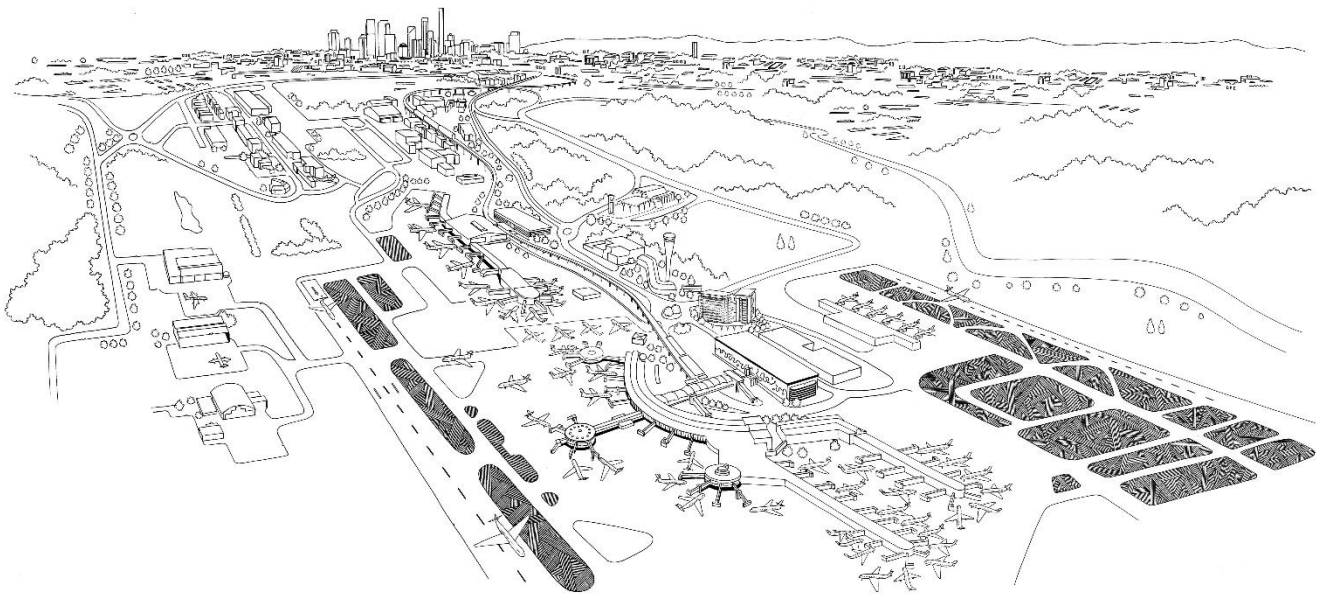

2.16 Low Visibility Procedures

To meet the requirements of Appendix 1 to CASR subparagraph 139.095(a) (ii) this section deals with particulars of the procedures for the management of ground activities at the aerodrome where low visibility operations are conducted, including details of the following.

- (i) The arrangements for measuring visibility along a runway and passing the information to air traffic control, if required;*
- (ii) The arrangements for minimising vehicular traffic within the movement area during periods of low visibility operations;*
- (iii) The arrangements for runway inspections during periods of low visibility operations;*
- (iv) The names and roles of the persons who are responsible for managing low visibility operations, and the telephone numbers for contacting them during and after work hours.*

The arrangements for measuring visibility along the runway and passing the information onto air traffic control, if required, can be found below.

2.16.1 Runway Visual Range (RVR)

The maximum distance in the direction of take-off or landing at which the runway, or specified lights or markers delineating it, can be seen from a position above a specified point on its centre line at a height corresponding to the average eye level of pilots at touch-down.

2.16.2 Runway Visibility (RV)

RV means the horizontal distance along a runway in which a person can see the runway surface markings or the lights delineating the runway or identifying its centreline.

For Brisbane Airport, RV Assessments are measured manually and undertaken by Airside Operations staff, in accordance with MOS Section 10.19.

2.16.3 Low Visibility Procedures (LVP)

Defined as procedures applied at an aerodrome for protecting aircraft operations during conditions of reduced visibility or cloud. CASA prescribes minimum visibility and cloud base (ceiling) requirements for the landing and take-off of aircraft. CASA makes pilots responsible for assessing if actual conditions meet these minimum requirements.

2.16.4 RWY 01R/19L ILS Protection

RWY 01R/19L ILS critical areas are kept clear at all times by all vehicles and equipment except with ATC approval for maintenance activities such as mowing operations. ILS critical areas are delineated in the airfield by white/red stakes installed in the ground. The Airside Operations staff shall be responsible for the monitoring and safe guarding of the ILS (i.e. Localizer and the Glide Path as per LOA 557)

When visibility reduces to 1500m or less, Airside Operations staff are responsible for securing the critical components of the Instrument Landing Systems (ILS) in accordance with *MOS 139 10.17.2.xi*. These components are the Glide Path Area (which is delineated with red and white stakes) and the localizer.

The Aerodrome Reporting Officer shall record the timings of these checks into Tracker Airside as Log Book entries as stated in *BAC Standard Operating Procedure (SOP) - Low Visibility Section 9*.

2.16.5 Departures

When Low Visibility Procedures are in progress, RWY 01R/19L can support take-offs with an RV of not less than 350 metres for CASA approved operators (refer ERSA FAC YBBN-6, Note 36). Pilots of departing aircraft rely on ATC to provide assessments of runway visibility, so they can delay engine start and taxiing until an appropriate RV is likely to be available.

For RV between 550m and 350m, operations on the manoeuvring area are restricted to one movement at a time and TWY B is the primary TWY used. Intersection departures are not permitted during LVP. Aerodrome Reporting Officers provide a "follow me" service for taxiing aircraft as required from the apron to RWY holding point. When RV is less than 350m all departures are ceased.

2.16.6 Arrivals

For Brisbane, RWY 01R/19L is equipped with CAT I ILS intended for operations with a decision height not lower than 60m (200FT) and RV not less than 800m. Pilots of arriving aircraft, particularly those intending to make an ILS approach, may also request RV assessments as an indication of the conditions they might expect during final approach and landing.

In some conditions, particularly from the cockpit height of a B747 lined up for take-off or when an aircraft is approaching over a shallow fog, pilots may have greater RV than the visibility observed at the runway surface. The final responsibility for assessment of visibility lies with the pilot in command. Aerodrome Reporting Officers provide a "follow me" service for taxiing aircraft as required.

2.16.7 Runway Visibility (RV) assessments

Runway Visibility (RV) is assessed from observations made by an Aerodrome Reporting Officer (being an appointed RV Assessor) from the runway centreline and may be made from the threshold and secondary observation points (RWY 01R – TWY Mike intersection, RWY 19L – TWY Hotel 3 intersection).

When visibility is less than 1500 metres or on ATC request, the Aerodrome Reporting Officer carries out a full length runway inspection. Subsequent inspections are to be undertaken at the request of ATC.

The Aerodrome Reporting Officer then waits at either stand-off point A or B. When requested by ATC to make RV assessments he/she enters and exits the runway using taxiway "Mike" or "Hotel 3". Entry or exit is not permitted via the "Alpha/Bravo" taxiway system as it is "active" during Low Visibility Procedures.

Adjacent the observation point, positioned on the runway centreline the Aerodrome Reporting Officer counts the number of runway lights visible on the eastern side of the runway, in the likely take-off or landing direction, and advises ATC of the RV (in metres) using the conversion chart provided in *BAC SOP - Low Visibility Section 9* (the runway light immediately adjacent the observation point is not counted).

Phraseology to be used is to be in the following format:

RUNWAY VISIBILITY,

RUNWAY {RUNWAY NUMBER},

THRESHOLD [distance assessed in metres and if applicable:

- secondary observation point, distance assessed in metres

ASSESSED AT [time] UTC.

An RV assessment may only be provided to a pilot if the assessment was conducted within the previous 20 minutes.

Attachment R - List of Certified Runway Visibility Assessors

Name	
Chris McCullen	Tammy Loewe
Scott Shaw	Clinton Day
Anthony Love	Tony Trappett
Adrian Bertini	Paul Connell
David Bishop	Graham Hockey
Rick Howell	Mary Lou Anning
Nathan Carroll	Mick Morris
Cameron Chaundy	Tim Baker
Brett Forknall	Neville Wood
Ross Gillespie	Niel Young
John Hansford	
As of April 2018	

Attachment S - Low Visibility Procedures – Alerting Checklist

Annex a) Low Visibility Procedures Alerting Checklist.

DECLARED (By ATC) _____ DATE/TIME _____ TERMINATED _____ TIME _____

ORGANISATION	TELEPHONE (BUSINESS)	TELEPHONE (ALTERNATE)	ADVISED ACTIVATED	ADVISED TERMINATED
AIP & ISS MOBILE PATROL	3406 5749	3406 3204 Talk to guards in person & radio		
AIRPORT SURVEILLANCE OFFICE (ASO)	3068 6642 Control Room	3068 6643 Control Room		
ALLIANCE	3212 1532	0401 690 834 Supervisor		
ARFF	3860 3210			
AUSTRALIAN FEDERAL POLICE	3624 5330	0407 909 065 Supervisor		
BAC DUTY CO-ORDINATION MANAGER	3406 3068	0419 650 036		
BAFS (JUHI)	3860 4644	DIVERTS TO MOBILE		
CUSTOMS	3867 3854 Control Room	3867 3855 Border Force		
DNATA	3305 9206	0409 240 041 Ramp 0466 312 791 Office		
JETSTAR	0421 050 979 (0400-0130)	0427 281 268 Duty Manager 0488318933 Ramp Manager		
QANTAS – OPS WILL NOTIFY ALL DEPTS +QLINK	3867 3211 Dom POCO	3867 3223		
TOLL Aviation	0407 701 373 Supervisor			
VIRGIN Australia – OPS WILL NOTIFY ALL DEPTS	0412 095 836 Ramp	3114 7066 Duty Manager		
Phone list current as of Jan 2017				

*ESSENTIAL THAT CONTACT BE MADE WITH ITS DUTY CO-ORDINATION MANAGER

2.16.8 General Arrangements

Visibility conditions determined by ATC are the 'visibility conditions' that apply to the whole maneuvering area and Low Visibility Procedures take effect as stated in *BAC SOP Low Visibility - Section 9*.

When visibility falls below 2400m RWY 14/32 is not available for use and the Letter of Agreement 406 (LoA406) between BAC and Airservices is suspended and airside works may be cancelled and removed from the airside.

When ATC declares visibility to be 1500 metres or less, the Team Leader shall notify the Duty Terminal Manager of reduced visibility below 1500m.

On ATC advice that visibility is greater than 1500 metres, the Team Leader shall notify the Duty Terminal Manager that visibility is improving above 1500 metres.

During periods of reduced visibility Aerodrome Reporting Officers provide a "follow me" service for taxiing aircraft and a vehicle escort service as required.

2.16.9 Airside security

When ATC declares visibility to be 1500 meters or less the Airside Operations Centre Duty Officer/ Team Leader notifies the Aerodrome Surveillance Officer (ASO) who secures all automatic gates to ensure that only vehicles essential to aircraft operations gain airside access during Low Visibility Procedures.

When the Airside Operations Centre Duty Officer/ Team Leader is satisfied that the airside perimeter is secure and that only essential vehicles are operating and under the control of Airline Ramp Team Leaders, he/she advises ATC.

Airside gates must be secure and notify ATC by 800 metres.

2.16.10 Logbooks

Each movement area inspection, RV assessment, and details of the first landing and take-off are recorded in the Aerodrome Reporting Officers logbook through Tracker Airside. All "follow me" and escort duties are also logged.

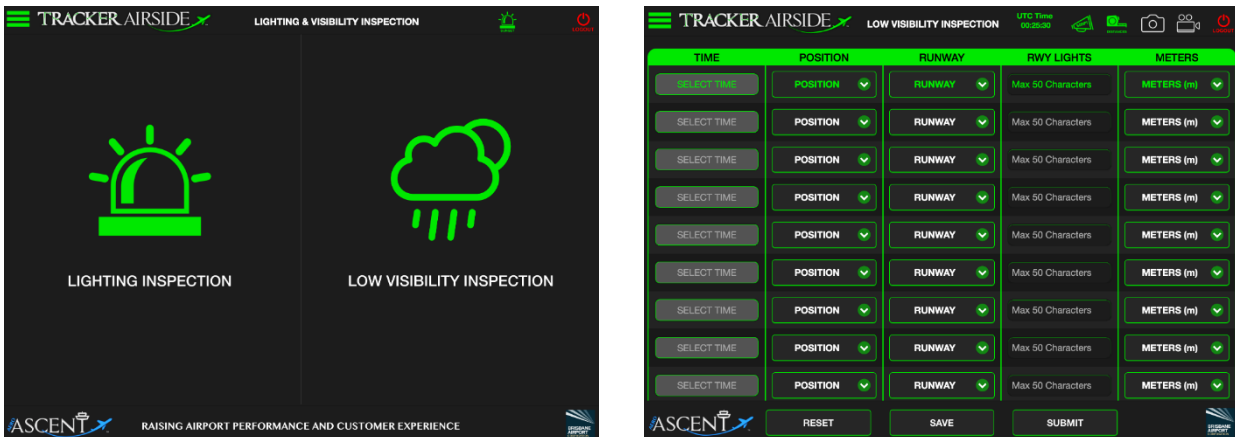

Figure 15 – Airside Tracker Low Visibility

2.16.11 Low Visibility – Decreasing Visibility Procedure

Low Visibility Roles and Responsibilities – Decreasing Visibility					Version1 16 May 2017
Visibility Distance	AOTL	DTM	RV Assessor	Other Aerodrome Reporting Officer'S	Restrictions
Less than 2400m	<ul style="list-style-type: none"> Notify staff that LOA 406 suspended Make log bog entry in Tracker Airside (TA) Cancel Airside works (if applicable 2400m) 	NIL	LOA 406 suspended	LOA 406 suspended	<ul style="list-style-type: none"> RWY 14/32 not for use Non-essential vehicles shall not be permitted on the Manoeuvring Area.
Less than 1500m	<p>All below entries require TA log book entry</p> <ul style="list-style-type: none"> Allocate resource for RVA Notify DTM of reduced visibility less than 1500m Contacts ASO and request automatic electronic gates 18, 20, 21, 23 and 40 are secured Notify AIP only vehicles essential to aircraft operations allowed entry Allocate resource to check ILS Allocate resources for follow me (ITB/DTB) Allocate resource for vehicle escorts Log timings of ILS checks 	<ul style="list-style-type: none"> Notifies stakeholders that visibility has reduced to less than 1500m, airside access is restricted to vehicles essential to ACFT operations. 	<ul style="list-style-type: none"> RWY Inspection 01R/19L (TA entry) RVA's (TA entry) ADZ AOTL of RVA results 	<ul style="list-style-type: none"> ILS protection (TA log book entry) DTB Follow Me (TA entry) ITB Follow Me (TA entry) Vehicle escorts as required (TA entry) Acknowledge RVA's on non ops 	<ul style="list-style-type: none"> All non-essential vehicles operating on the airside shall cease operations Airside speed limits are reduced to 20km/h Only vehicles essential to aircraft operations gain airside access
Less than 800m	<ul style="list-style-type: none"> Advise ATC that the above gates are locked and secure Notify DTM of reduced visibility less than 800m 	<ul style="list-style-type: none"> Notifies stakeholders that visibility has reduced to less than 800m 	As above	As above	As above
Less than 350m	<ul style="list-style-type: none"> Notify DTM of reduced visibility less than 350m 	<ul style="list-style-type: none"> Notifies stakeholders that visibility has reduced to less than 350m 	As above	As above	As above
Between 150 and 100 m	<ul style="list-style-type: none"> Notify the JUHI to activate their red flashing light 	NIL	As above	As above	Red flashing light advises JUHI staff visibility below 150m, escorts required
Less than 100 m	<ul style="list-style-type: none"> Notify DTM of reduced visibility less than 100m Notify AIP airside closed to all vehicles 	<ul style="list-style-type: none"> Notifies stakeholders that visibility has reduced to less than 100m Apron areas closed to all vehicle movement 	As above	As above	<ul style="list-style-type: none"> Apron areas of the aerodrome shall be closed to all airside vehicle movement

2.16.12 Low Visibility – Increasing Visibility Procedure

Low Visibility Roles and Responsibilities – Increasing Visibility					Version1 16 May 2017
Visibility Distance	AOTL	DTM	RV Assessor	Other Aerodrome Reporting Officer'S	Restrictions
More than 100 m	<ul style="list-style-type: none"> Notify DTM of improving visibility more than 100m Notify AIP airside open to vehicles, restricted to vehicles essential to ACFT operations. 	<ul style="list-style-type: none"> Notifies stakeholders that visibility improved to more than 100m Apron areas open to essential vehicle movement 	<ul style="list-style-type: none"> RWY Inspection 01R/19L (TA entry) RVA's (TA entry) ADZ AOTL of RVA results 	<ul style="list-style-type: none"> ILS protection (TA log book entry) DTB Follow Me (TA entry) ITB Follow Me (TA entry) Vehicle escorts as required (TA entry) Acknowledge RVA's on non ops 	<ul style="list-style-type: none"> RWY 14/32 not for use Apron areas restriction lifted Airside speed limits reduced to 20km/h Only vehicles essential to aircraft operations gain airside access
More than 150m	<ul style="list-style-type: none"> Notify the JUHI to turn off their red flashing light 	NIL	As above	As above	As above
More than 350m	<ul style="list-style-type: none"> Notify DTM of improving visibility more than 350m 	<ul style="list-style-type: none"> Notifies stakeholders that visibility has improved to more than 350m 	As above	As above	As above
More than 800m	<ul style="list-style-type: none"> Notify DTM of improving visibility more than 800m 	<ul style="list-style-type: none"> Notifies stakeholders that visibility has improved to more than 800m 	As above	As above	As above
More than 1500m	<ul style="list-style-type: none"> Notify DTM of improving visibility more than 1500m 	<ul style="list-style-type: none"> Notifies stakeholders that visibility has improved to more than 1500m 	As above	As above	<ul style="list-style-type: none"> LOA still suspended Other restrictions lifted
More than 2400m	<ul style="list-style-type: none"> Notify AOC staff LOA 406 reinstated LVP cancelled 	NIL	OPS normal	OPS normal	Nil restrictions

2.16.13 Roles and Responsibilities

The General Manager Operations or delegate develops local procedures in conjunction with ATC, to ensure more rigorous airside security in low visibility conditions, and to provide ATC with assessments of runway visibility.

Aerodrome Reporting Officers are responsible for arranging the securing of airside gates, inspecting the maneuvering area, providing RV assessments to ATC, notifying DTMs and JUHI operators, providing vehicle escorts and follow-me services.

The Duty Terminal Manager in the International Terminal assists in implementing the agreed procedures with notification to Stakeholders.

The aircraft refueling company shift Supervisors liaise with Airline Ramp AOC Team Leaders and Aerodrome Reporting Officers to co-ordinate operations of fuelling tankers and other oil company vehicles during low visibility conditions.

Airlines are responsible for security of their respective terminals, freight and catering complexes and maintenance hangars, and for the control of vehicles on their apron areas.

The names and telephone numbers of the responsible BAC staff are provided on the Telephone Contact List at the front of the Manual.

References

MOS Part 139 – Aerodromes

Section 10.17 Aerodrome Safety Procedures during Low Visibility Procedures

Attachment T - Table of Observed Distances

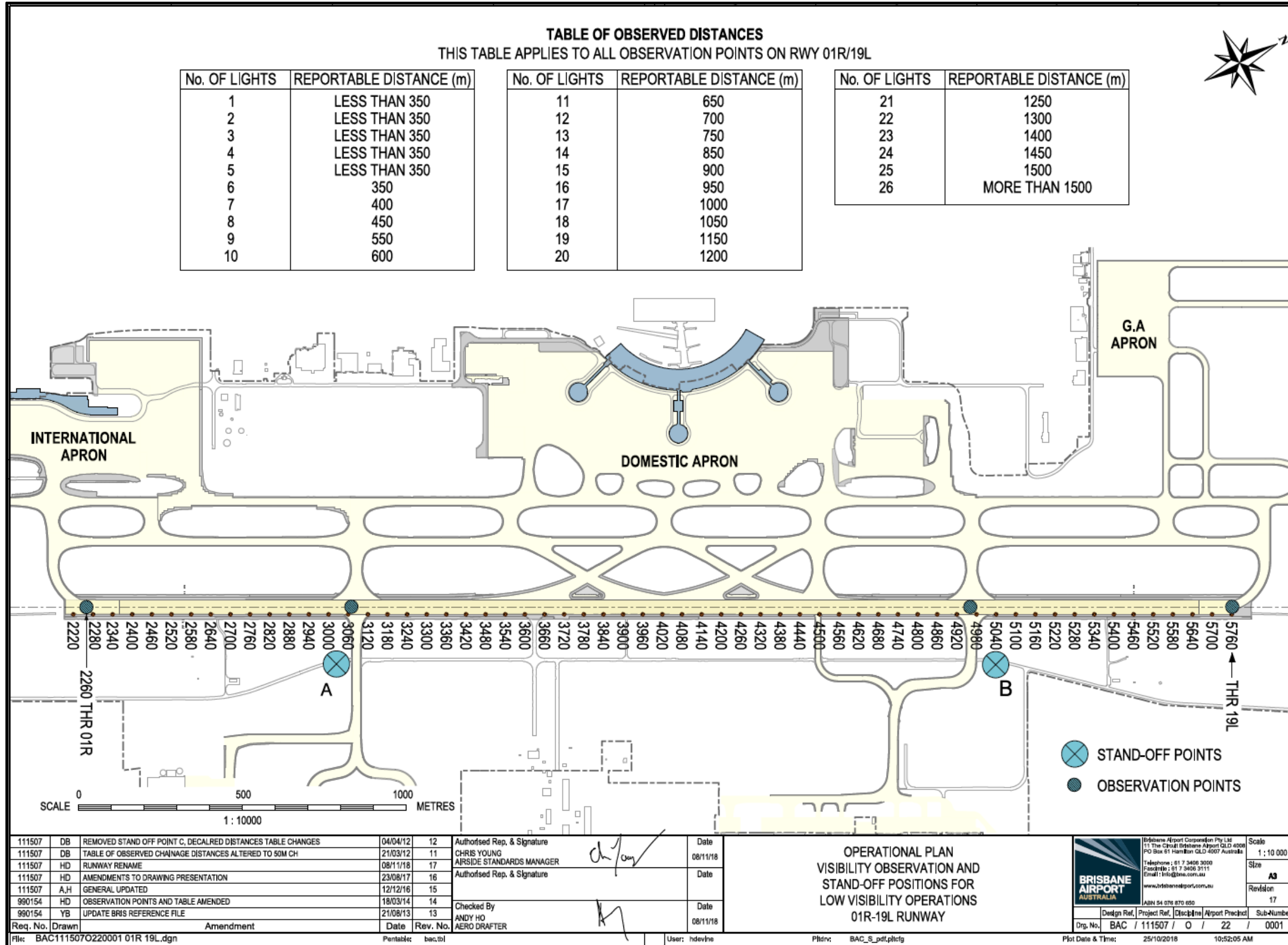

Part 2

Section 17 – Logbooks

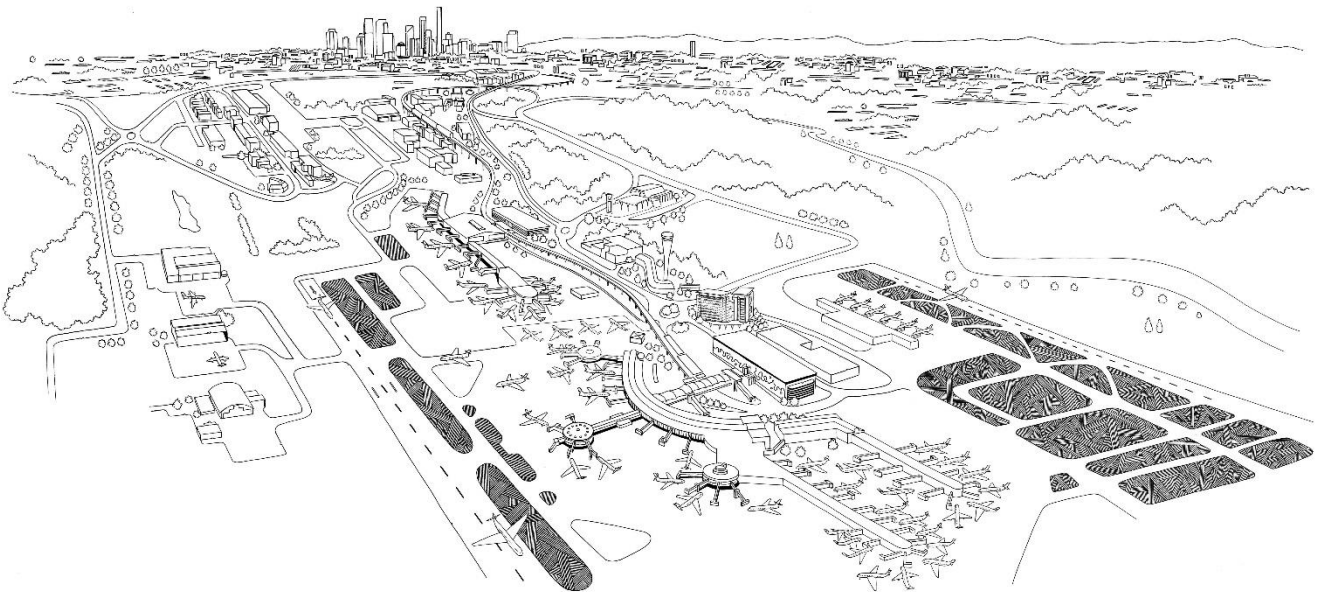

2.17 Logbooks

This section deals with the requirements for keeping logbooks and records of other operational documents at Brisbane Airport, including the following details:

2.17.1 Logbooks and other operational documents

Tracker Airside logs and records details of airport serviceability inspections, reporting actions and NOTAM requests, airport works, breaches of airside driving rules, bird harassment, OLS infringements, hazardous materials incidents, and actions taken during low visibility operations.

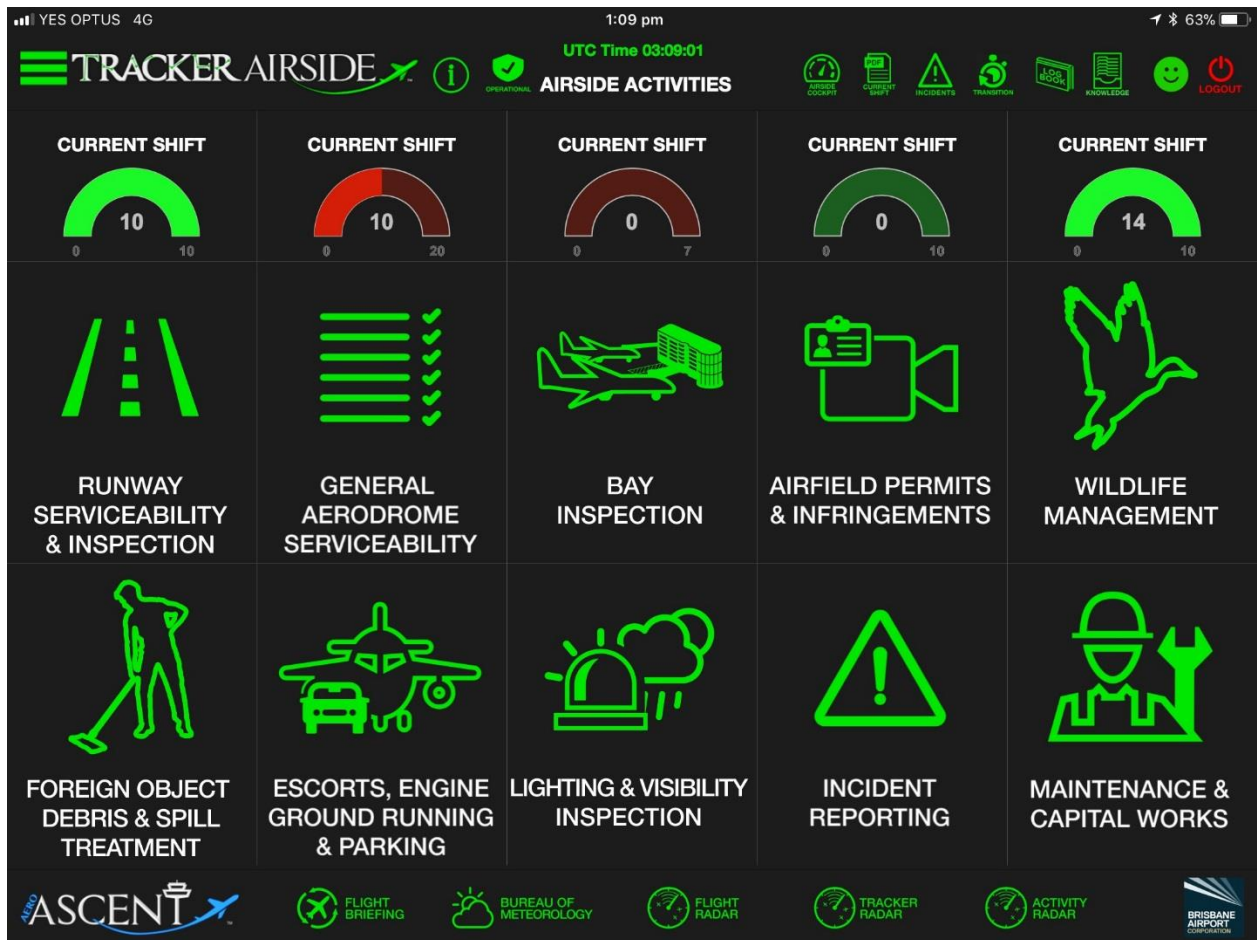

Figure 16 – Tracker Airside – Activities

2.17.2 Daily Duty Log

Tracker Airside records Logbook the activities of the Aerodrome Reporting Officers on an ongoing basis during and on completion of activities.

The duty Aerodrome Reporting Officers record the following type of information through Tracker Airside, preceding each entry with the date and time of occurrence:

- inspections carried out during the shift;
- specific tasks performed during the shift;
- location and type of articles found on the movement area;
- portions of the movement area withdrawn from or returned to operations;

- any unusual occurrence, e.g. bird strikes, unauthorised movement of persons, vehicles or plant on the movement area, aircraft incidents or accidents etc.;
- pavement failures or other unserviceability;
- details of all notice(s) to airmen (NOTAM) issued;
- bird movements on or in the vicinity of the airport;
- breaches of airside driving rules;
- hazardous materials incidents;
- details of pavement inspections required as a condition of a pavement concession;
- time limited works or Method Of Working Plan (MOWP) works; and
- defects, damage or unusual operation of lighting noted during a serviceability inspection.

Tracker Airside is used by the Aerodrome Reporting Officers to record serviceability inspections conducted in accordance with the procedures detailed in Part 2, Section 6 (Aerodrome Serviceability Inspections) of the Manual. All facilities inspected are digitally recorded regardless of serviceability or not. Sample Tracker Airside functionality Screen Shots



Figure 17 – Tracker Airside

2.17.3 Pavement defects reporting

If the duty Aerodrome Reporting Officer detects a pavement deficiency or anomaly he/she records details in Tracker Airside which includes reporting into the CMMS as a Maintenance Request.

2.17.4 Airfield lighting

Following the detailed weekly check of aerodrome lighting the Aerodrome Reporting Officer records details in Tracker Airside through to CMMS.

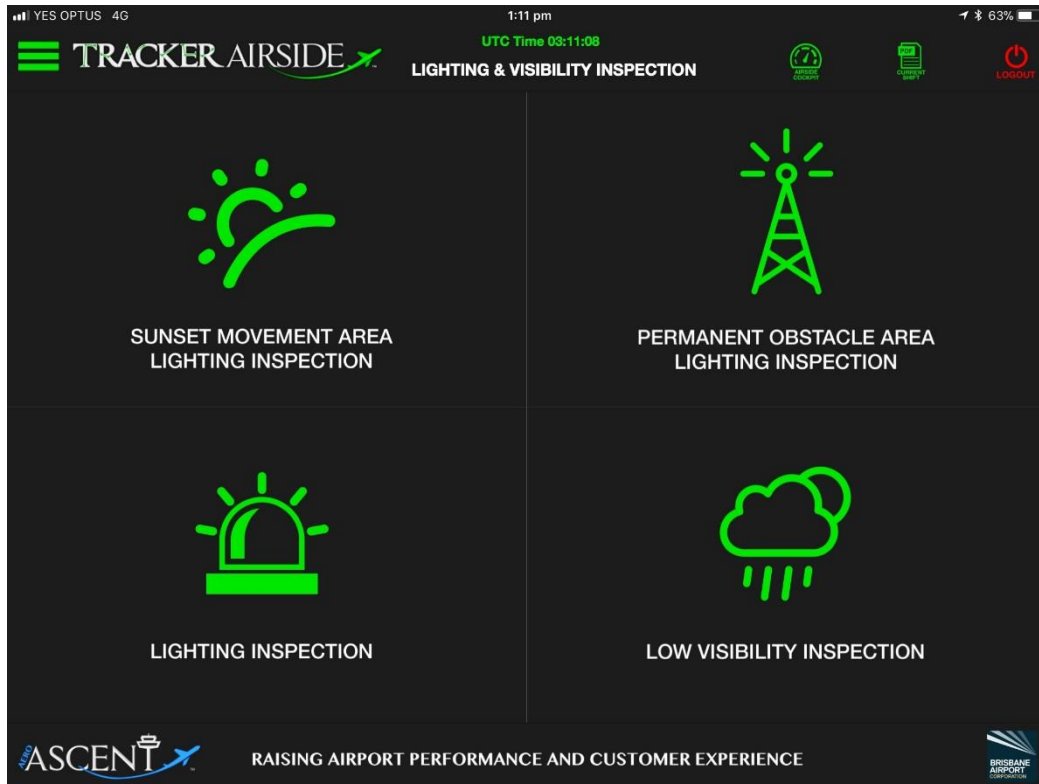

Figure 18 – Tracker Airside Lighting Inspection

The Airfield Electrical Maintenance Officers maintain a logbook recording details of all lighting faults reported (from any source) and subsequent maintenance action. Significant faults are transferred to Maximo. Routine technical inspections and subsequent fault maintenance are also recorded. The logbook is supported by site diaries at each Airport Lighting Equipment Room. Completed technical inspection checklists are filed in the CMMS.

2.17.5 Correspondence with government agencies

The Airside Operations Manager or delegate retains file copies of all correspondence exchanged with CASA, the NOF and the Aeronautical Information Service (AIS) concerning permanent changes in published information. Details of the annual approach survey are filed with the technical and safety inspection report.

2.17.6 Reports following technical inspections

The Airport Facilities Manager or delegate prepares a written report following each technical inspection. He/she retains the original on file and forwards a copy to the Airside Standards Manager, or delegate. Records of inspections made following a Pavement Defects Report are recorded on the form, which is then filed.

2.17.7 Prescribed airspace

The Airside Standards Manager or delegate maintains a register of all height enquiries received, whether for a temporary or permanent structure. All records of decisions made in assessing the operational impact of a proposed structure are filed by the Airside Standards Manager.

2.17.8 Roles and Responsibilities.

The telephone numbers can be found on the Telephone Contact List at the front of the Manual.

Part 2

Section 18 – Pavement Concessions

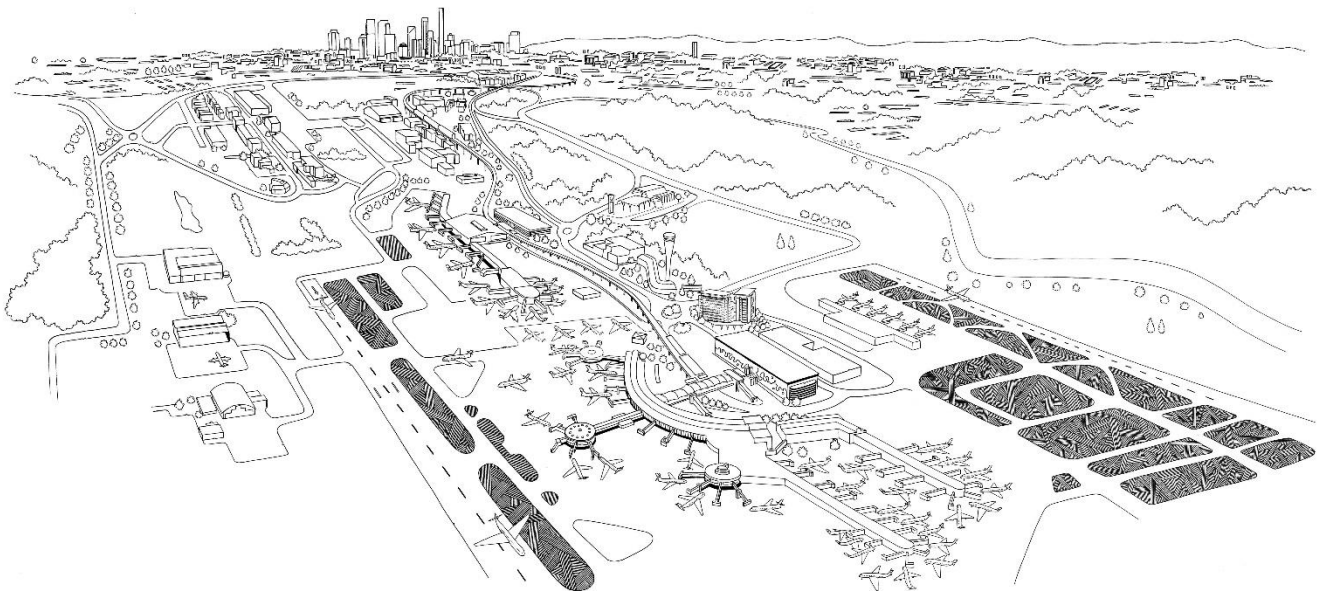

2.18 Pavement Concessions

This section deals with particulars of the procedures for granting pavement concessions, including:

2.18.1 Purpose of pavement concessions

A pavement concession allows the airport operator to gain the advantage of occasional heavier/larger aircraft operations on aircraft pavements of lesser design standard without significant cost outlay or reduction in pavement life. A pavement concession is regarded as a pavement management tool. A concession is normally granted on economic grounds, after airport management weighs the advantage to be derived from allowing some pavement overload, against the possible repair costs or reduced pavement life involved. The need for a pavement concession arises if the aircraft loading (ACN) and/or tyre pressure exceeds the strength (PCN) and/or tyre pressure rating of the pavement which is published in AIP-ERSA.

2.18.2 Arrangements for granting pavement concession requests

Aircraft operators apply for consideration of a pavement concession by letter, facsimile or email to the Airside Standards Manager, or delegate giving full details of the proposed movement(s).

The Airport Facilities Manager or delegate considers each application and responds by letter, facsimile or email as soon as practicable. He/she seeks technical assessment from the General Manager Assets, or delegate as required. If a concession is granted he/she also advises ATC and Airside Operations Centre of the conditions imposed. The grant of a pavement concession does not imply an operational concession, which may have to be obtained separately from CASA.

Should pavement damage be evidenced during this period, a pavement concession may be withdrawn at BAC's discretion.

2.18.3 Roles and Responsibilities

The Airside Standards Manager or delegate considers all applications for pavement concessions from aircraft operators and decides if they should be approved. The Airside Standards Manager or delegate keeps a record of all pavement concession applications and approvals on file. The General Manager Assets or delegate provides technical assessment and advice on aircraft pavements.

If specified as a condition of approval, an Aerodrome Reporting Officer inspects the movement area pavements following the overload operation, logs all details, and submits a damage report to the Airside Operations Manager and Airside Standards Manager or delegate.

The telephone numbers of BAC staff nominated in this procedure can be found on the Telephone Contact List at the front of the Manual.

References

MOS Part 139 – Aerodromes

Attachment U - Pavement Designations and Strengths

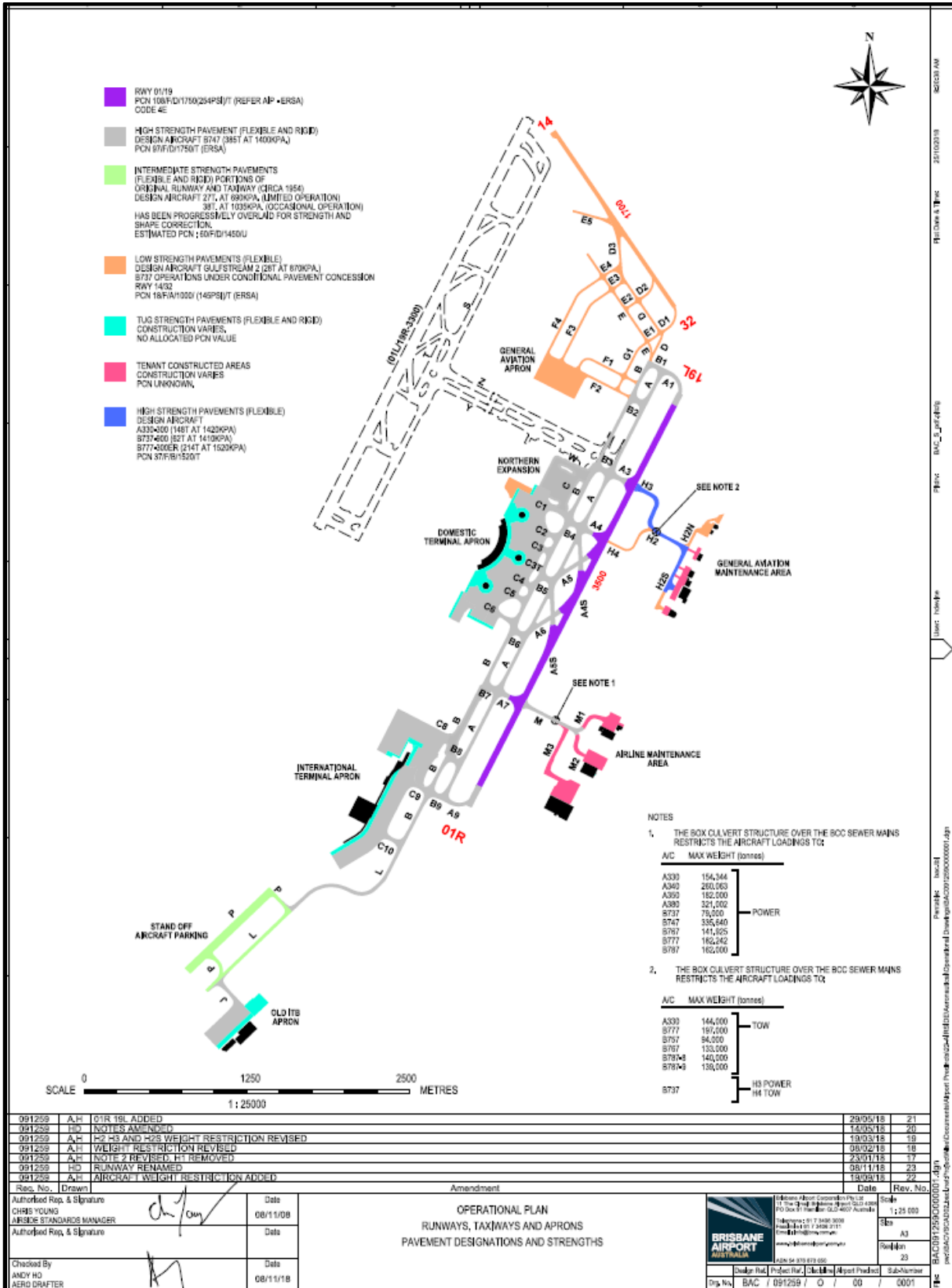

Part 2

Section 19 – Livestock Transfers

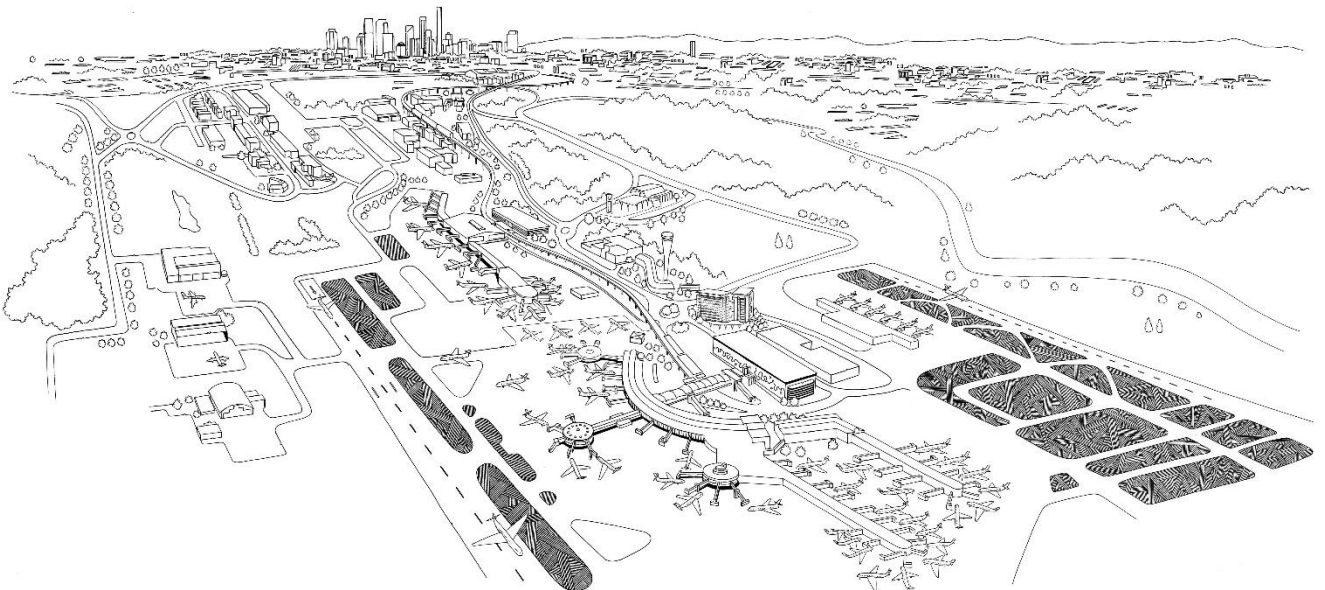

2.19 Livestock Transfers

This section deals with particulars of the procedures for the safe transfer of livestock between the landside at Brisbane Airport and an aircraft, including the following:

2.19.1 The arrangements for organising a livestock transfer

Precautions need to be taken to ensure that livestock involved in transfers to or from an aircraft do not escape and pose a safety hazard to aircraft or the public.

The airline coordinator (the nominated representative of the aircraft operator or aircraft ground handling agent) provides the Duty Terminal Manager, or delegate with the following information 48 hours prior to any proposed livestock transfer at Brisbane Airport:

- expected date and time of arrival or departure of livestock cargo;
- type of aircraft involved;
- type of operation (domestic or international);
- the aircraft operator or ground handling agent involved;
- flight number of the aircraft;
- name and telephone/fax numbers of the airline coordinator;
- client details;
- name and telephone/fax numbers of the client coordinator;
- expected number of staff involved;
- type and number of livestock; and
- number of trucks/floats and IATA (or equivalent) approved containers/crates required for the operation.

The request for a livestock transfer operation and the above information is then submitted to the Airside Operations Centre (which provides a 24 hour availability contact point), 48 hours prior to the intended operation, to allow organisation of Aerodrome Reporting Officer escort and other logistics as required.

If a transfer is scheduled during a long weekend or on a recognised public holiday, Airside Operations Centre requires the information 48 hours before commencement of that holiday period. If required, the Airside Operations Manager, or delegate liaises with the Duty Terminal Manager to arrange a suitable aircraft parking location.

The airline co-ordinator arranges security clearances for any personnel engaged in the transfer who do not have an Aviation Security Identification Card. The client co-ordinator (the nominated representative of the livestock owner or handling agent) arranges specialised equipment and ensures that experienced handlers are involved in the livestock transfer.

The airline and client co-ordinators are responsible for cleaning up debris (including disposal of quarantine waste, crates, litter, animal waste etc.) left on the apron and loading areas.

Arrangements for carrying out the transfer include the following standard procedures.

2.19.2 Standard procedures

When carrying out transfer/delivery of livestock to delivery point such as freight shed or hangar areas, all landside/airside access points must be closed/secured during delivery or transfer of livestock into secure pens to prevent potential escape of livestock to the airside area during transfer.

Whenever possible, livestock should be transferred between landside and the aircraft in suitable containers or crates to minimise the risk of an animal escaping airside. Containers must be IATA (or equivalent) approved for undertaking livestock transfers, if this is not made clear as part of the livestock transfer request made to BAC the transfer may not be approved.

Livestock must remain within the freight shed/hangar area until such time as the livestock can be taken and loaded directly onto the aircraft with minimum waiting time on the aprons (livestock in the appropriate containers/crates should not be stored or left to wait on the apron for more than 30 minutes, prior to commencing loading operations).

Livestock may be loaded into or from airline containers/crates on the Airside of Brisbane Airport if a secure corral area is established by the aircraft operator, ground handling agent or client. The Logistics (LPB) apron is the preferred location for livestock transfers. For any other location, prior approval must be sought from BAC through the Airside Operations Manager or Airside Coordination Manager. Direct transfers between a truck/float are only permitted via a secure race, which must be provided by the aircraft operator, ground handling agent or client. Livestock are not to be walked on the apron area under any circumstances.

An Aerodrome Reporting Officer is required to be present to monitor the safety precautions taken in transferring of all livestock transfers, and to maintain two-way radio contact with ATC, as part of the overall Aerodrome Reporting Officer escort. If livestock escapes either airside or landside on Brisbane Airport, the airline/client co-ordinator must notify Airside Operations. If any livestock escapes airside, the duty Aerodrome Reporting Officer immediately advises ATC, and then lends assistance in the livestock recapture. If landside, the airline/client co-ordinator must act immediately to protect BAC property and to ensure the safety of the public.

2.19.3 Non-standard procedures

BAC appreciates the complexity of this type of operation. If the above procedures are unsuitable for a particular livestock transfer, the following personnel meet to determine acceptable alternatives:

- Airside Operations Manager;
- Airside Coordination Manager
- Duty Terminal Manager (if aircraft parking issues are involved);
- Airside Standards Manager;
- Airside Safety Systems Manager;
- Airline Co-coordinator; and
- Client Co-coordinator.

2.19.4 Roles and Responsibilities

The Airside Operations Manager, or delegate co-ordinates BAC's review and response to proposed livestock transfer operations, and ensures an Aerodrome Reporting Officer is available to monitor the operation.

An Aerodrome Reporting Officer monitors the safety precautions taken during the loading and unloading of livestock and ensures the subsequent clean-up of the apron and loading areas is conducted satisfactorily by the airline or client co-ordinator.

The telephone numbers of BAC staff nominated in this procedure can be found on the Telephone Contact List at the front of the Manual.

Part 2

Section 20 – Engine Ground Running

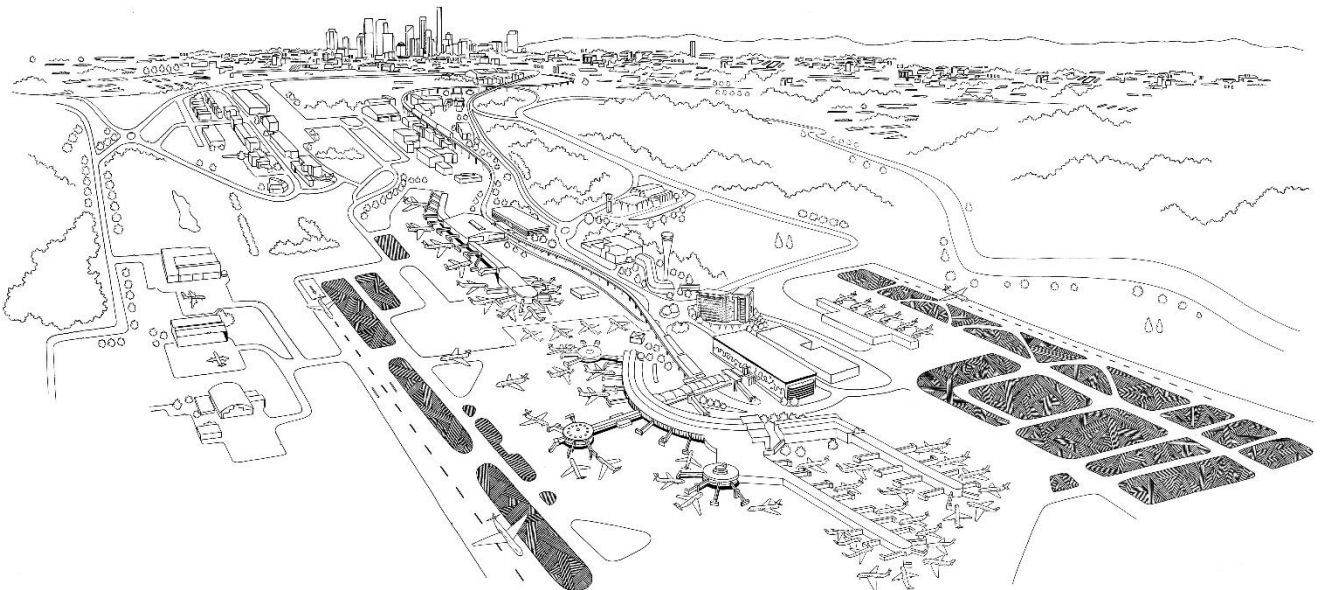

2.20 Engine Ground Running

This section deals with particulars of the procedures for minimising aircraft noise associated with engine ground running at Brisbane Airport, including the following:

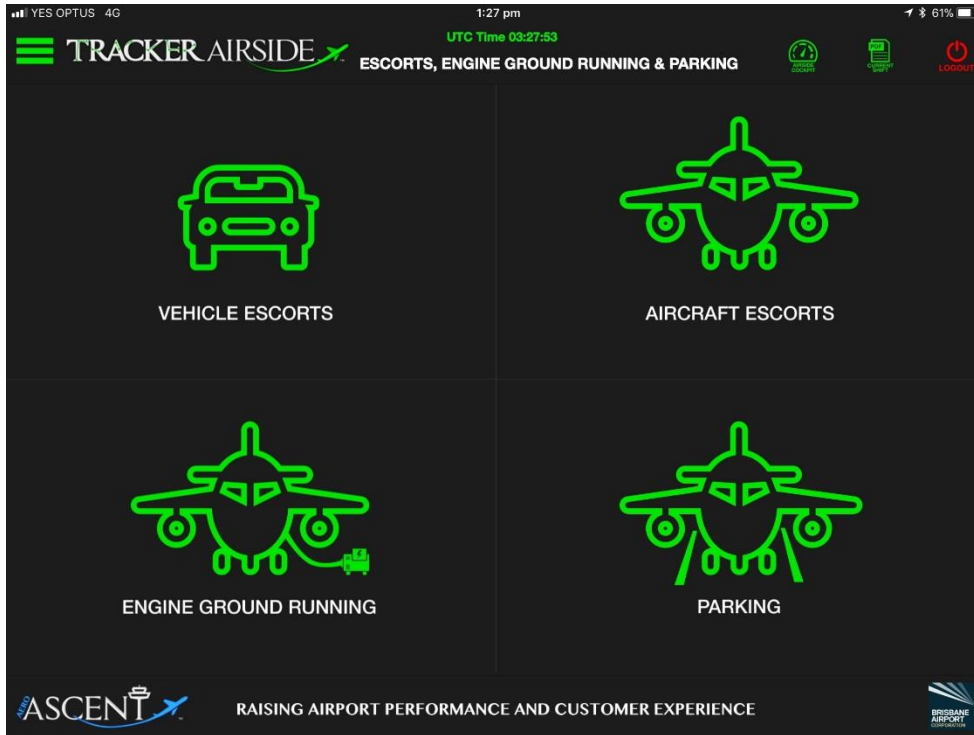

Figure 19 – Tracker Airside Engine Ground running

NOTE: This section should be read in conjunction with the Brisbane Airport Environment Strategy which is adopted as Annex 5 to this Manual.

2.20.1 Legal basis

Part 5 of the *Airports Act 1996* and its associated regulations require BAC to prepare an *Airport Environment Strategy* (AES) for Brisbane Airport. The AES is required to specify measures for monitoring, controlling, preventing or reducing environmental impacts associated with airport operations including the generation of noise from the airport site (other than noise generated by aircraft in flight). The *Airports (Environment Protection) Regulations* also contain guidelines to assist the Airport Environment Officer (AEO) in determining whether noise from ground-based aircraft operations is excessive.

Regulation 4.06 of the *Airports (Environment Protection) Regulations 1997* requires airlines and other aircraft operators to take all reasonable and practicable measures to prevent or minimise the generation of offensive noise. If the AEO considers the noise generated to be excessive, regulation 7.03 of the *Airports (Environment Protection) Regulations 1997* provides him/her with the authority to direct compliance.

Amongst other things, the AES requires examination of measures to minimise the noise exposure from engine ground running at Brisbane Airport. Arrangements for carrying out engine ground running include the following.

2.20.2 Locations, time and power setting limitations

The locations available, times and power setting limitations on engine ground running are as specified in Attachment V.

For ALL engine ground runs that are required to be positioned on the maneuvering area (excluding those for propeller driven aircraft), an Aerodrome Reporting Officer will meet the aircraft engineers onsite at the selected location to ensure correct positioning of aircraft.

Operators “are not” required to contact BAC - Airside Operations Centre or ATC Ground Frequency for idle only aircraft engine runs that occur on Hangar Aprons and Aircraft Stands.

All other engine runs (on taxiways and/or above idle) require the aircraft operator to communicate with Ground Frequency, post the initial approval from BAC – Airside Operations Centre (ph. 07 3406 3072). This does include idle runs on TWY’s (e.g. Hotels and Mike TWY system).

Regulations require that Brisbane Airport have procedures for reducing environmental impacts associated with airport operations including the generation of noise, and therefore BAC still have a requirement to be notified by all operators to conduct engine ground runs as per attachment V.

2.20.3 Non-complying engine ground running

Non-complying engine ground runs will not be approved due to noise abatement.

2.20.4 Reporting

The Airside Operations Centre records details in Tracker Airside of all ground running conducted as displayed in figure 18.

In cases where a dispensation has been obtained for a non-complying engine ground run, details justifying the ground run shall be recorded.

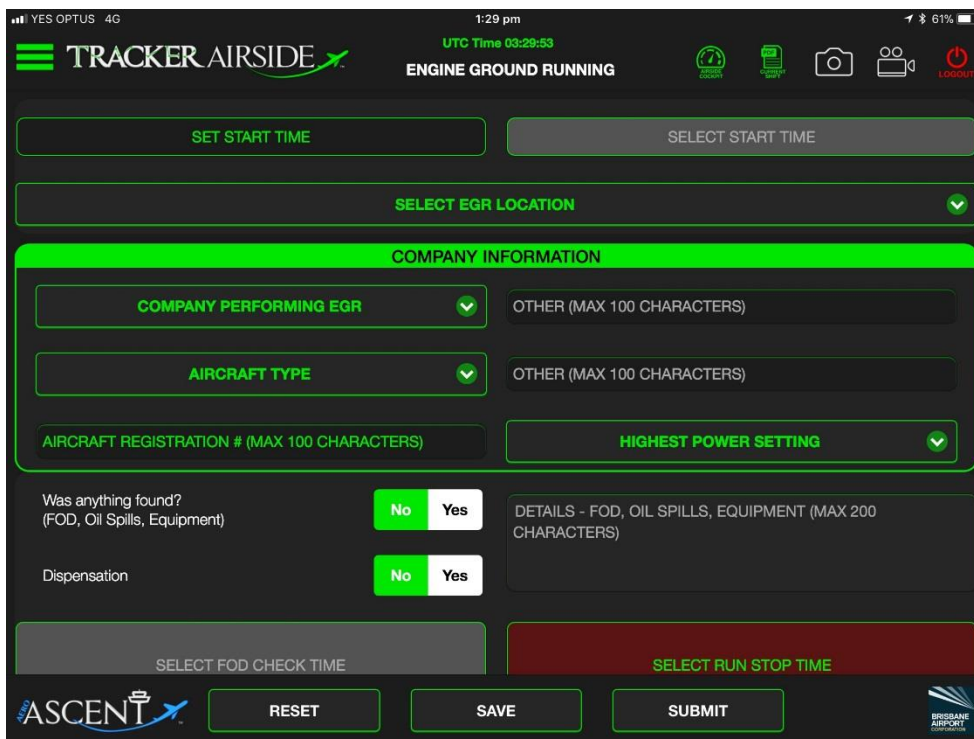

Figure 20 – Tracker Airside Engine Ground running Reporting

2.20.5 Engine Ground Run Checklist:

- ✓ ALL Operators required to request approval from BAC Airside Operations Centre (Telephone: 3406 3072), prior to commencement of any engine ground running in accordance with 20.2.2 and Attachment V requirements.
- ✓ Abnormal engine ground run requirements – noise levels associated with these need to be known beforehand where possible

- ✓ Where a time limit applies to a maximum allowable ground run duration the total time allowed is the cumulative time at the relevant throttle settings, e.g. 5 minutes means a total time above idle setting of five minutes
- ✓ All aircraft ground runs on TWYs or RWYs, to be strictly aligned with TWY/RWY centerline. A duty Aerodrome Reporting Officer/Team Leader will meet the aircraft engineer onsite at the selected location to ensure correct positioning/alignment of aircraft (excluding propeller driven aircraft operations)
- ✓ Up to B767/A330 type aircraft: section of TWY Lima aligned east-west, available only subject to WX conditions and BAC approval. Aircraft conducting ground runs at this location required to give way to all aircraft requiring access to/from LPB apron
- ✓ TWYs Delta & Echo available up to B737 (<66000KG) only subject to WX conditions and BAC approval
- ✓ F100 aircraft to face south only for ground run operations on TWY Hotel-3; and
- ✓ ALL Jet engine ground runs on TWY M3 require company observation vehicle on TWY Mike to maintain listening watch at ALL times (121.7 MHz). Company vehicle to stop traffic traversing onto M3. Nose wheel markings are installed on TWY M3 to indicate where to position aircraft nose wheel on TWY M3 centerline. BAC AOC staff to be onsite to ensure correct positioning of aircraft prior to engine run commence
- ✓ East- facing ground runs not permitted on TWY Mike-3.

2.20.6 Roles and Responsibilities

The CEO has overall responsibility for the implementation of the AES for Brisbane Airport which, among other things, aims to minimise noise generated from the airport site.

The General Manager Operations or delegate ensures that engine ground running procedures are developed to specify the locations and conditions applicable to that activity at Brisbane Airport. The Airside Operations Manager or delegate considers applications for non-complying engine ground runs.

The Airside Operations Centre implements the procedures. He/she selects a location and aircraft orientation in consultation with ATC. For locations on the maneuvering area, the Aerodrome Reporting Officer will ensure aircraft is positioned correctly prior to commencement of engine ground run.

Aerodrome Reporting Officers shall notify the Airside Operations Manager, or delegate of any contravention of the procedures.

The Airside Operations Centre shall contact the Airside Operations Manager, or delegate in accordance with BAC administrative procedures for advice where operators require dispensation against time or power setting limitations.

The telephone numbers of BAC staff nominated in this procedure can be found on the Telephone Contact List at the front of the Manual.

Attachment V - Engine Ground Running Limitations

Aircraft Type	Time of Day	Allowable Power Setting	Maximum Allowable Ground Run Duration	Locations Available – with BAC approval required.
All aircraft types	24/7	Idle Only	No limit	BAC approval not required
Piston engine aircraft, or any aircraft <8000KG MTOW	0500-2100	Above Idle	No limit	All TWYs TWY PAPA not available
	2100-2300	Above Idle	No limit	All TWYs TWY PAPA not available
	2300-0500	Above Idle	5 minutes total	All TWYs TWY PAPA not available
All Dash 8 type aircraft, ATR-72, or any aircraft <29000KG MTOW	0500-2100	Above Idle	No limit	All TWYs TWY PAPA not available
	2100-2300	Above Idle	No limit	All TWYs TWY PAPA not available
	2300-0500	Above Idle	No limit	All TWYs TWY PAPA not available
BAe 146, Embraer Jets	0500-2100	Above Idle	No limit	All TWYs TWY PAPA not available
	2100-2300	Above Idle	15 minutes total	All TWYs TWY PAPA not available
	2300-0500	Above Idle	5 minutes total	TWYs A, B, E, F, L TWY PAPA not available
F100,F70, B717, B737, A320/1	0500-2100	Above Idle	No limit	TWYs A, B, E, F, L, M1, M2, M3 TWY PAPA not available
	2100-2300	Above Idle	15 minutes total	TWYs A, B, E, F, L, M1, M2, M3 TWY PAPA not available
	2300-0500	Above Idle	Nil	Nil
B787, B777, A330, A350 or any aircraft >83000KG MTOW not specifically referenced above. Refer weight restrictions for infrastructure.	0500-2100	Above Idle	No limit	TWYs A, B, L, M3 TWY PAPA not available
	2100-2300	Above Idle	15 minutes total	TWYs A, B, L, M3 TWY PAPA not available
	2300-0500	Above Idle	Nil	Nil

Attachment W - Mike Three Engine Ground Run Position

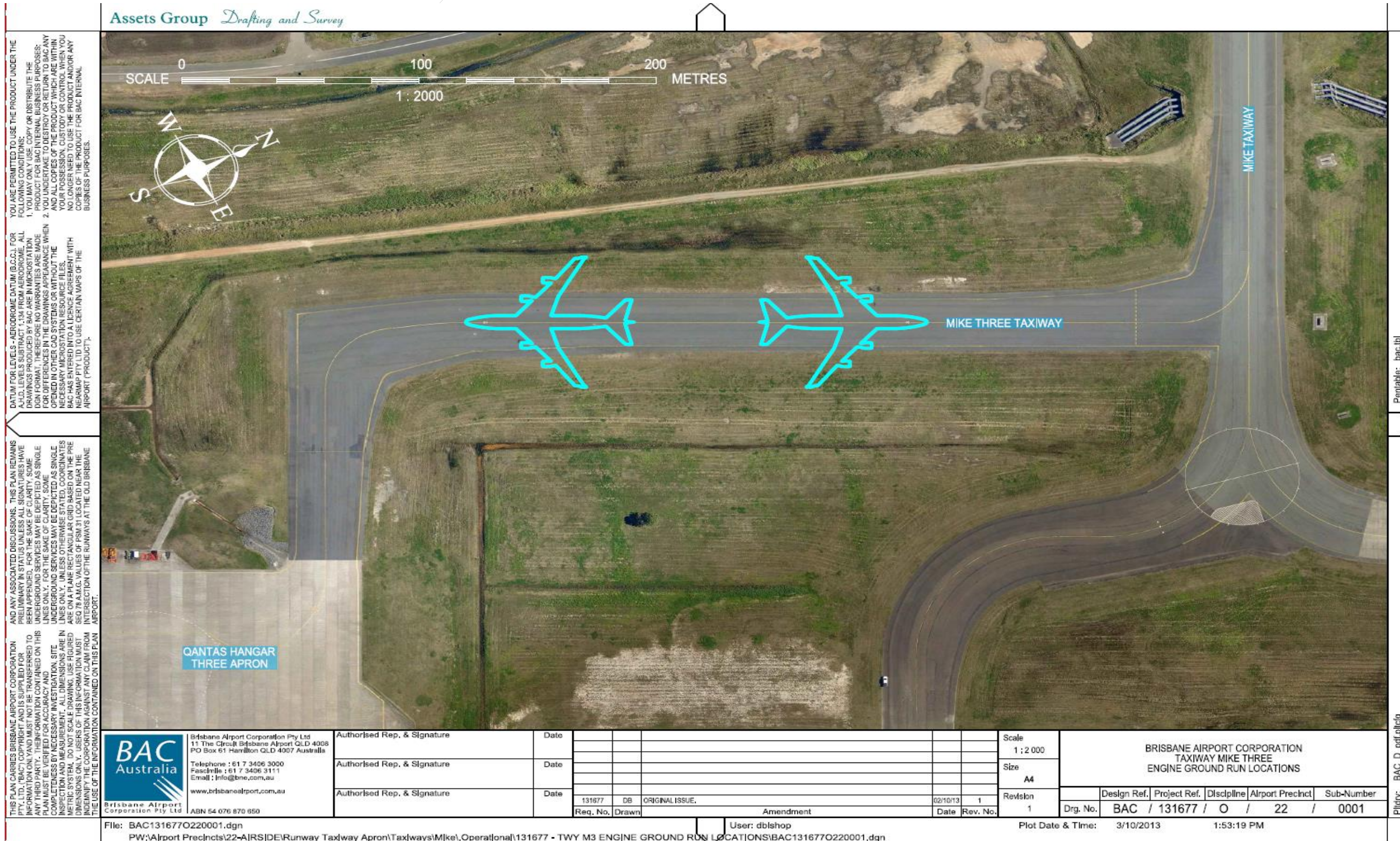

YOU ARE PERMITTED TO USE THE PRODUCT UNDER THE FOLLOWING CONDITIONS:

1. YOU MAY ONLY USE COPY OR REPRODUCE THE PRODUCT FOR BAC INTERNAL BUSINESS PURPOSES.
2. YOU UNDERTAKE TO DESTROY OR RETURN TO BAC ANY AND ALL COPIES OF THE PRODUCT WHICH ARE WITHIN YOUR POSSESSION, CUSTODY OR CONTROL WHEN YOU NO LONGER NEED TO USE THE PRODUCT AND/OR ANY COPIES OF THE PRODUCT FOR BAC INTERNAL BUSINESS PURPOSES.

DATUM FOR LEVELS - AERODROME DATUM (A.D.) FOR ALL LEVELS SUBTRACT 1.34 FROM AERODROME ALL DRAWINGS PRODUCED BY BAC ARE IN MICROSTATION DGN FORMAT. THEREFORE NO WARRANTIES ARE MADE FOR DIFFERENCES IN THE DRAWINGS APPEARANCE WHEN OPENED IN OTHER CAD SYSTEMS OR WITHOUT THE NECESSARY MICROSTATION RESOURCE FILES. BAC HAS ENTERED INTO A LICENCE AGREEMENT WITH NEARMAP PTY LTD TO USE CERTAIN MAPS OF THE AIRPORT ("PRODUCT").

AND ANY ASSOCIATED DISCUSSIONS. THIS PLAN REMAINS PRELIMINARY IN STATUS UNLESS ALL SIGNATURES HAVE BEEN APPENDED. FOR THE SAKE OF CLARITY, SOME UNDERGROUND SERVICES MAY BE DEPICTED AS SINGLE LINES ONLY. FOR THE SAKE OF CLARITY, SOME UNDERGROUND SERVICES MAY BE DEPICTED AS SINGLE LINES ONLY. UNLESS OTHERWISE STATED, COORDINATES ARE ON A PLANE RECTANGULAR GRID BASED ON THE PRE SEQ 78 A.M.G. VALUES OF PSW 31 LOCATED NEAR THE INTERSECTION OF THE RUNWAYS AT THE OLD BRISBANE AIRPORT.

THIS PLAN CARRIES BRISBANE AIRPORT CORPORATION AND IS SUPPLIED FOR INFORMATION ONLY AND MUST NOT BE TRANSFERRED TO ANY THIRD PARTY. THE INFORMATION CONTAINED ON THIS PLAN MUST BE VERIFIED FOR ACCURACY AND COMPLETENESS BY NECESSARY INVESTIGATION, SITE INSPECTION AND MEASUREMENT. ALL DIMENSIONS ARE IN METRIC SYSTEM. DO NOT SCALE DRAWING. USE FIGURED DIMENSIONS ONLY. USERS OF THIS INFORMATION MUST INDICATE THE CORPORATION AGAINST ANY CLAIM FROM THE USE OF THE INFORMATION CONTAINED ON THIS PLAN

Brisbane Airport Corporation Pty Ltd
 11 The Circuit Brisbane Airport QLD 4008
 PO Box 61 Hamilton QLD 4007 Australia
 Telephone : 61 7 3406 3000
 Facsimile : 61 7 3406 3111
 Email : info@bne.com.au
 www.brisbaneairport.com.au
 ABN 54 076 870 850

Authorised Rep. & Signature	Date	Req. No.	Drawn	Amendment	Date	Rev. No.

Scale	1 : 2 000	BRISBANE AIRPORT CORPORATION TAXIWAY MIKE THREE ENGINE GROUND RUN LOCATIONS				
Size	A4	Design Ref.	Project Ref.	Discipline	Airport Preclnt	Sub-Number
Revision	1	BAC / 131677 / O	22	22	22	0001
Drg. No.	1	Plot Date & Time: 3/10/2013 1:53:19 PM				

File: BAC131677O220001.dgn
 PW:\Airport Preclncts\22-AIRSIDE\Runway Taxiway Apron\Taxiways\Mike\Operational\131677 - TWY M3 ENGINE GROUND RUN LOCATIONS\BAC131677O220001.dgn

Plotdrv: BAC_D_pdl.plt09
 Pentable: bac.tbl

Part 2

Section 21 – Compass Swing

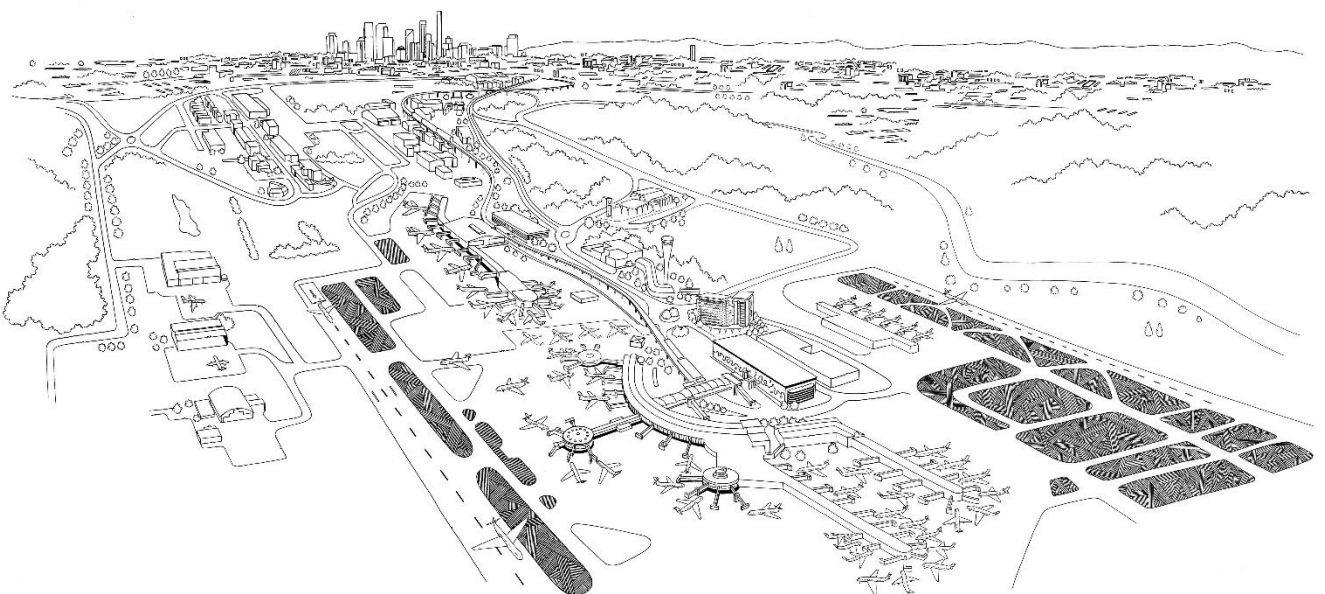



2.20 Compass Swing

This section deals with the particulars and procedures for conducting compass swing calibrations at Brisbane Airport.

Brisbane Airport is equipped with a 48m diameter Class 1 certified compass swing, located between taxiway M1 and M2.

This site is available to airlines and maintenance organisations on approval from Brisbane Airport Corporation. All requests for approval are to be made a minimum of 48 hours prior to use through the Airside Operations Centre (Telephone: 3406 3072).

It is the operator's responsibility to ensure they maintain appropriate clearance to the taxiway edges and contact operators in the surrounding hangars to ensure there are no aircraft movements within the timeframe planned for the use of the compass swing site.

Attachment X – Compass Swing Site Surveys Letter



Wednesday 27 July 2016

William Fonua
Roads and Drainage Engineer
Assests Group
Brisbane Airport Corporation Pty Limited

Dear William,

Brisbane Airport Compass Swing Site Surveys

A Compass Swing Site Surveys was conducted at Brisbane Airport between 28 - 29 June 2016. A certification survey was undertaken on the existing Class 1 located on Taxiway M at the intersection with Taxiway M1 & M2 (refer compass swing site location map at Attachment A). The compass swing survey was required for 4 yearly validation.

The Class 1 site is a 48 metre diameter area (refer Class 1 site map at Attachment B) which was surveyed. The site survey was completed in accordance with Reference A. The results of the survey are contained in the Survey Data Sheets at Attachment C.

A number of points within the site had magnetic deviations in excess of the Class 1 requirements (commonly referred to as 'hot spots'), but as the areas were considered avoidable, it was not considered detrimental to the use of the site. These hot spots have been marked on site, and should be avoided by both aircraft magnetic detectors and compass equipment used by maintenance personnel, when taking measurements.

The sites marking have been replaced as per previously marked. Site markings should be inspected annually by users and repainted where required.

SURVEYORS OF EXCELLENCE

New South Wales
1A Fletcher Street
P.O. Box 3085
Tamarama, 2026
Telephone (02) 9365 7336
Facsimile (02) 9130 3278

Queensland
167 Lake Weyba Drive
P.O. Box 46 (Gibson Rd)
Noosaville, 4566
Telephone (07) 5442 4451

Victoria
20-30 Malcolm Rd
Braeside, 3195
Telephone (03) 9588 2987
Facsimile (03) 9580 9870

Email admin@LLsurveys.com.au Mobile: 0419 316 591

L&L and Fulton Hogan wishes to thank all Brisbane Airport personnel involved for their assistance. Any questions on the results of this survey should be addressed to:

Alastair Linke
Registered Surveyor
Email: a.linke@LLsurveys.com.au
Mobile: 0419316591

Yours Faithfully,



ALASTAIR LINKE Registered Surveyor
Director
Ph. +61 2 93657336
Mob +61 419316591
Fax +61 2 91303278
Email a.linke@llsurveys.com.au

Reference:

- A. AAP 7090.001-99(AM1) Instruction No. 24 "Survey Management and Maintenance of ADF Aircraft Compass Swing Sites

Attachments:

- A. **Brisbane Int** Compass Swing Site Locality Plan.
- B. **Brisban Int** Class 1 Compass Swing Site Plan.
- C. Survey Data Sheets – **Brisbane Int** Class 1 Site.

Attachment Y – Compass Swing Site Surveys Data



COMPASS SWING SITE SURVEY

LOCATION: BRISBANE INTERNATIONAL AIRPORT					SURVEYOR: A.LINKE / S.SHARMA					
SITE: Taxiway M, Intersection of Taxiway M1 & M2					DATE: 28-29 JUNE 2016					
INSTRUMENT MASTER: WATTS DATUM SN 118202					TIME: 0700 - 1700					
INSTRUMENT MOBILE: WATTS DATUM SN 115760					SHEET: 1 OF 1					
	POS1	POS2	POS3	POS4	POS5	POS6	POS7	POS8	POS9	POS10
DEVIATION:	0.2	-0.2	0.1	0.0	0.1	0.0	0.0	0.0	0.0	-0.1
	POS11	POS12	POS13	POS14	POS15	POS16	POS17	POS18	POS19	POS20
DEVIATION:	-0.1	0.0	0.0	0.0	0.1	0.1	0.1	0.0	0.2	0.0
	POS21	POS22	POS23	POS24	POS25	POS26	POS27	POS28	POS29	POS30
DEVIATION:	-0.1	0.0	-0.1	0.0	0.0	0.0	0.0	-0.2	0.0	0.1
	POS31	POS32	POS33	POS34	POS35	POS36	POS37	POS38	POS39	POS40
DEVIATION:	0.1	0.15	-0.7	-0.6	0	0	0	-0.1	0	0
	POS41	POS42	POS43	POS44	POS45	POS46	POS47	POS48	POS49	POS50
DEVIATION:	-0.1	-0.15	0	-0.1	-0.1	0	-0.1	-0.1	0	0
	POS51	POS52	POS53	POS54	POS55	POS56	POS57	POS58	POS59	POS60
DEVIATION:	0.15	0.2	0.15	0	0.1	0.2	0.4	0.3	0.3	0.4
	POS61	POS62	POS63	POS64	POS65	POS66	POS67	POS68	POS69	POS70
DEVIATION:	0.2	0	0.1	0	0.1	-0.1	0.1	0.1	0.1	-0.1
	POS71	POS72	POS73	POS74	POS75	POS76	POS77	POS78	POS79	POS80
DEVIATION:	0	0.15	0	0	0	0.1	0.2	0.3	0.4	0.4
	POS81	POS82	POS83	POS84	POS85	POS86	POS87	POS88	POS89	POS90
DEVIATION:	0.3	0.1	0	0.1	0.1	-0.1	0	0.1	0	0
	POS91	POS92								
DEVIATION:	0.1	0								

27/07/2016

ATTACHMENT C TO LLFH_COMPASSSWING_BRISINT270716

Attachment Z – Compass Swing Site Surveys Line Marking

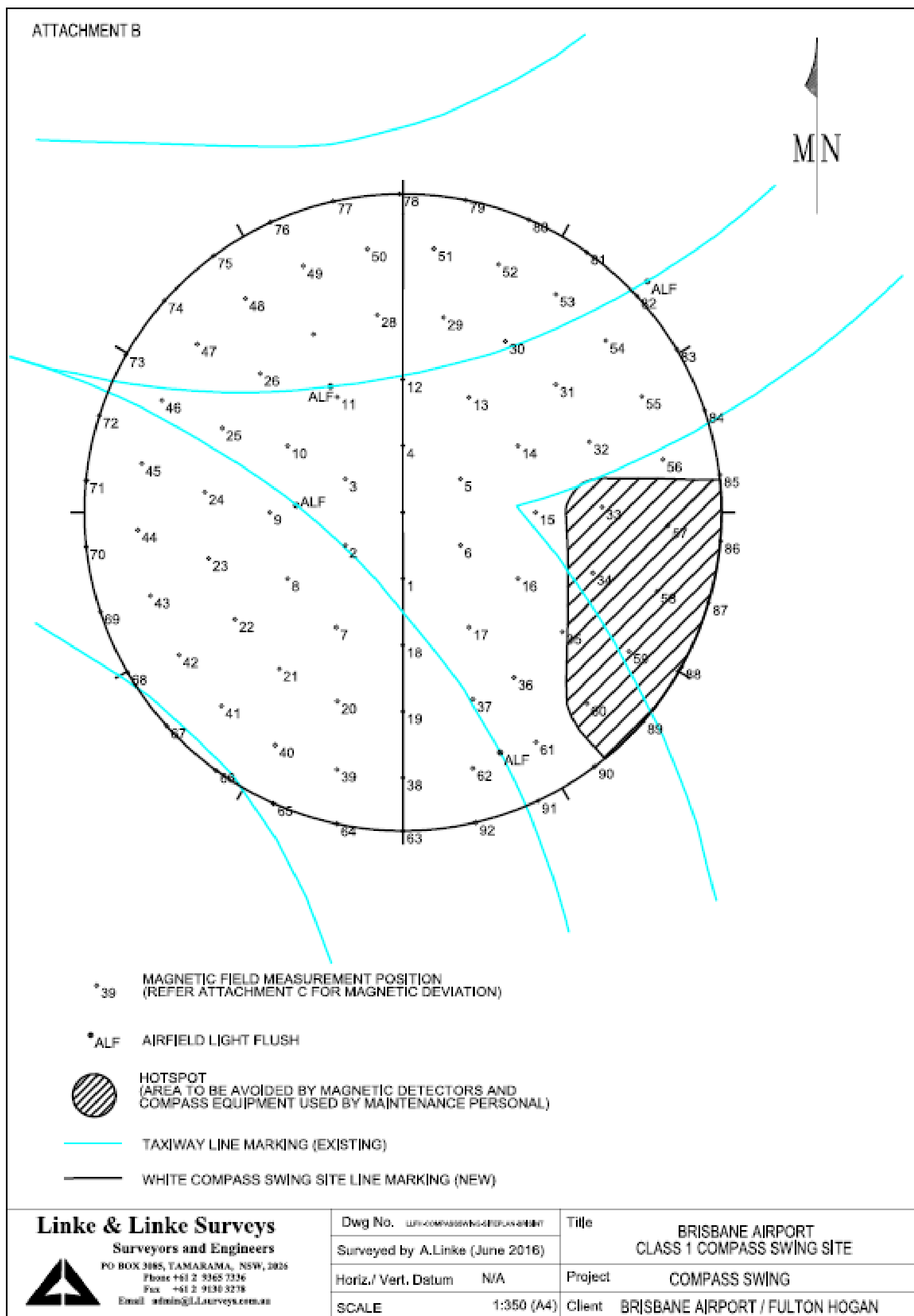

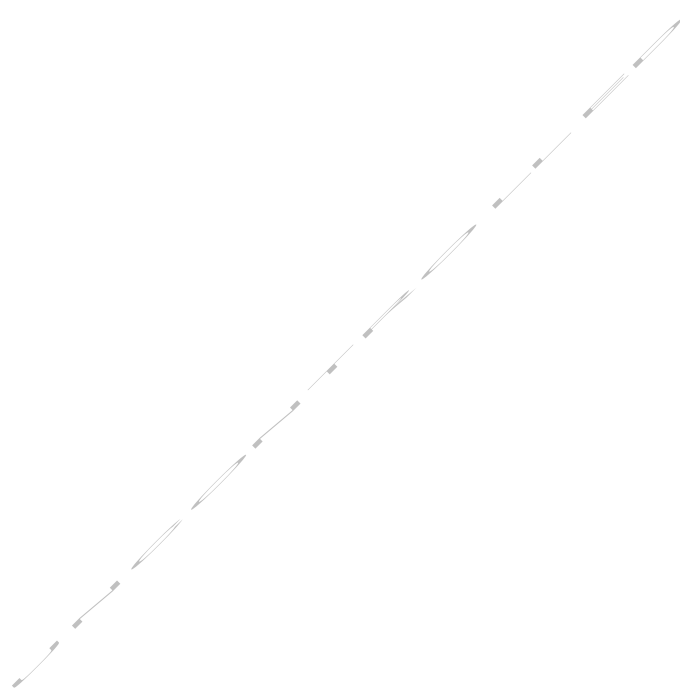

Part 3

Particulars of Aerodrome to be published in AIP Section 1 – Aerodrome General Information

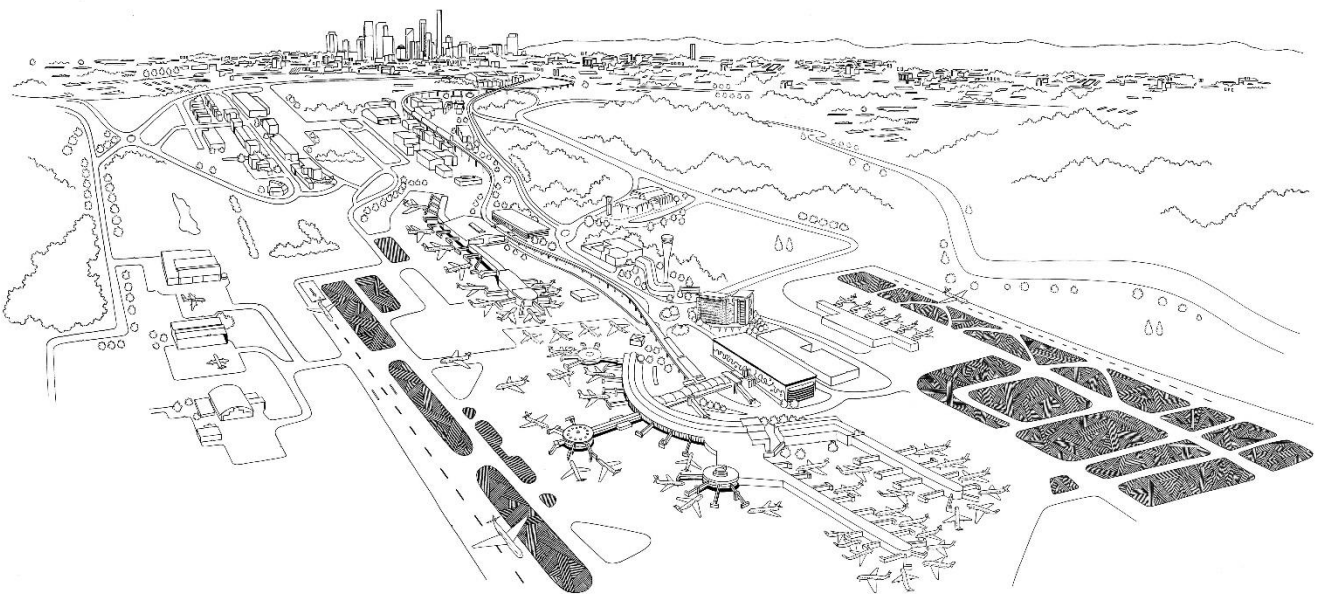



3.1 General information

To meet the requirements of Appendix 1 to CASR subparagraph 139.095(a) (ii) this section deals with particulars of the aerodrome general information including:

- (i) The name of the aerodrome;
- (ii) The State or Territory where the aerodrome is located;
- (iii) The geographic coordinates of the aerodrome reference point;
- (iv) The elevation of the aerodrome, based on the Australian Height Datum;
- (v) Details of the aerodrome beacon;
- (vi) The name of the aerodrome operator and the address and telephone numbers at which the aerodrome operator may be contacted at all times.

It is advantageous to include information on taxiway widths if this is not already annotated on the aerodrome drawing.

3.1.1 Aerodrome Information

This Aerodrome is a Security Controlled Airport.

Aerodrome Name:	Brisbane International Airport		
State:	Queensland		
Geographic Co-ordinates:	S 27 23.0E	153 07.1	VAR 11 DEG E
Elevation:	13 Feet		
Aerodrome Operator:	Brisbane Airport Corporation Pty Ltd 11 The Circuit, Skygate Brisbane Airport QLD 4008 PO Box 61 Hamilton QLD 4007 Telephone: 61 7 3406 3000 Fax: 61 7 3406 3111 Web Site: www.bne.com.au		
Duty Terminal Manager:	H24 T 61 7 3406 3171		
Airfield Operations (Safety/ Security):	H24 T 61 7 3406 3072	F 61 7 3406 3116	
General Manager OPS:	BH T 61 7 3406 3000	F 61 7 3406 3101	
Aerodrome Charges:	All ACFT	BH T 61 7 3406 3000	



3.1.2 Air Traffic Flow Management Procedures

3.1.2.1 Runway Demand Management Scheme (RDMS)

Brisbane RDMS is applicable to all airline and ACFT operators using Brisbane airport. All flights operating into and out of Brisbane must obtain an Airport Coordination Australia (ACA) slot in accordance with AIP ENR 1.9.

General Aviation (GA) apron operations are subject to runway/apron slot management. Approved slot holders operating on the GA apron are to confirm allocated parking with Brisbane Airport Corporation on 07 3406 3171 prior to arrival.

For full information regarding the Brisbane RDMS see BAC (Brisbane Airport Corporation) website: <http://www.bne.com.au/corporate/airlines-aviation/runway-demand-management-scheme>.

3.1.2.2 Runway 14/32: Flow Aircraft Pavement Concession

A320 - up to 200 series with weight limit of 66,000KG & MAX tyre pressure of 1450KPA;

F28 - all variants, no weight or tyre pressure limitation;

F100 - all variants, no weight or tyre pressure limitation;

BA146 - all variants, no weight or tyre pressure limitation;

B717 – all variants with weight limit of 49,895 KG and max tyre pressure of 1131KPA;

B737 - all variants with weight limit of 66,000 KG & MAX tyre pressure of 1475KPA;

EMB170/190 - all variants with weight limit of 56,000 KG & MAX tyre pressure of 1350KPA.

NOTE: Should pavement distress become evident the concession to OPR specific Type of ACFT may be withdrawn.

This Aerodrome is a Security Controlled Airport.

3.1.3 Permanent NOTAMs

None in circulation.

3.1.4 Passenger Facilities

The BACL does not provide marshalling services. All requests for ACFT marshalling should be directed to the Airline companies or a FBO.

3.1.5 Rescue and Fire Fighting Services

Airservices Australia maintain this data for ERSA



3.1.6 Handling Services and Facilities

BP - Australian Air Support Services Pty Ltd:	D H24, FAX 61 7 3216 3010. Jet A1, O125. Caltex, BP, Mobil	Phone 61 7 3860 5996
Brisbane Airport Fuel Services:	D 1900-0900 FAX 61 7 3860 4298 JET A1 O125 Caltex & BP Shell Carnet Card	Phone AH 61 7 3860 4647 0439 986 046
Zip Airport Services Pty Ltd.	FAX 61 7 3860 4866	Phone 61 7 3860 4844
Zip Airport Services Pty Ltd	1630-1330 MON-FRI 1900-1130 SAT 1900-1230 SUN AH call out fee may apply PN required. BIZ-JET	
Zip Airport Services Pty Ltd	GA 2100-0900 MON-FRI 2000-0400 SAT-SUN JET A1 and AVGAS Shell Fuel and Fly Shell Global Carnet Card and Credit Cards (VISA and MC).	

3.1.7 Aerodrome Obstacles

OBST unmarked refinery tower 288FT, BRG 164DEG M/2.3NM from Brisbane VOR infringes inner HZS by 132FT.

OBST building 872FT AMSL BRG 215 MAG 8.84NM FM 'BN' VOR infringes outer horizontal SFC by 372FT.

OBST crane lit 355FT AMSL PSN BTN 065 MAG 2.3NM and 106 MAG 1.6NMFM VOR infringes HZS by 199FT

OBST Buildings and Cranes BRG/DIST FM VOR

354FT BRG 082M/3,480M LGT 198FT ABV INNER HZS

354FT BRG 097M/3,110M LGT 198FT ABV INNER HZS

276FT BRG 110M/2,950M LGT 120FT ABV INNER HZS

210FT BRG 168M /2.84NM LGT 54FT ABV INNER HZS

210FT BRG 175M/2,920M UNLIT 54FT ABV INNER HZS

158FT BRG 173M/3,000M Painted and LGT, 2FT ABV INNERHZS

355FT BRG 074M/3,600M LGT 199FT ABV INNER HZS

838FT BRG 212M /8.5NM LGT 338FT ABV OUTER HZS

716FT BRG 214M /8.3NM LGT 216FT ABV OUTER HZS

576FT BRG 214M /8.8NM LGT 76FT ABV OUTER HZS

540FT BRG 215M /8.8NM LGT 40FT ABV OUTER HZS



670FT BRG 213M/8.4NM LGT, 170FT ABV OUTER HZS

822FT BRG 214M/8NM LGT, 322FT ABV OUTER HZS

3.1.8 Meteorological Information Provided

TAF CAT A, METAR/SPECI, TTF, AD WRNG, WS WRNG

MET INFO AVBL FM Air Services Pilot Briefing

Elaborative briefing FM MWO 61 7 3229 1854

AWIS PH 07 3007 4155 – Report faults to BoM.

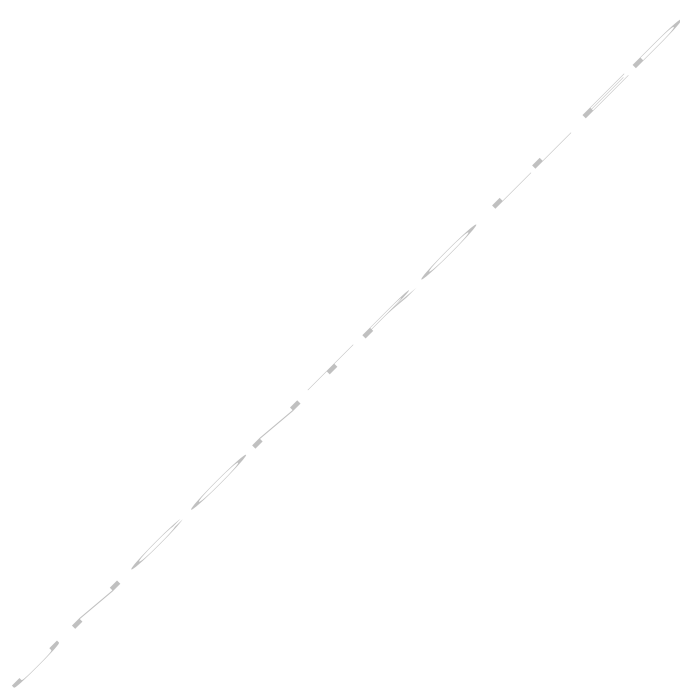

Part 3

Section 2 – Information for Runways

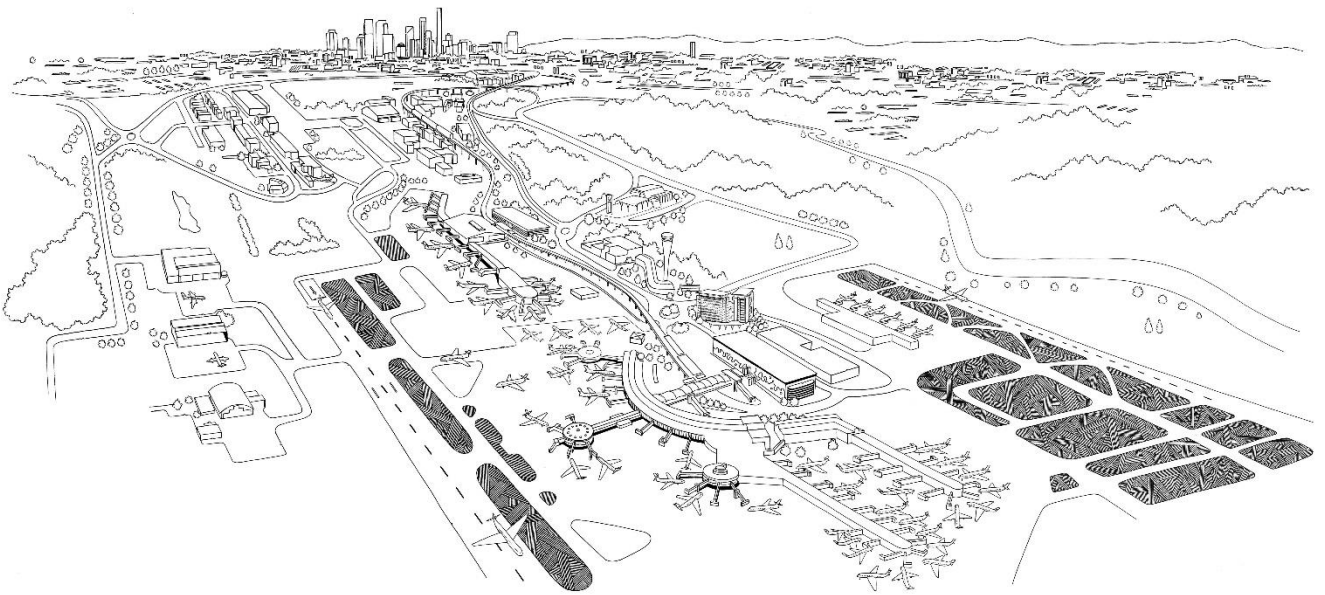



3.2 Information for Runways

To meet the requirements of Appendix 1 to CASR subparagraph 139.095 (a) (ii) this section deals with particulars of the aerodrome runways including:

- (i) The magnetic bearing of the runway and the runway number;
- (ii) The runway reference code number for the approach and take-off areas that have been surveyed;
- (iii) The length, width and slopes of the runway;
- (iv) The length and width of the graded and overall runway strip;
- (v) The pavement surface type and its strength rating;
- (vi) The runway declared distances and take-off gradient;
- (vii) The supplementary take-off distances;
- (viii) The Aerodrome Obstacle Chart Type A, if applicable.
 - Include details of runway shoulders where constructed.
 - Set out the information similar to the layout in ERSA.
 - Include RL of runway THR [as published in DAP]

3.2.1 Physical Characteristics

01R/19L 016 117a PCN 108 /F/D/1750 (254PSI)/T WID 45 RWS 300

100M(328) N & S ends concrete. Grooved

14/32 135 56a PCN 18 /F/A/1000 (145PSI)/T WID 30 RWS150

RWY 01R THR displaced 60 (197). RWY 14/32 THR displaced 60 (197)

3.2.2 Declared Distances for Runways - Brisbane

RWY (CN)	TORA	TODA	ASDA	LDA
01R (4)	3500 (11483)	3620 (11876) (1.2%)	3560 (11680)	3500 (11483)
RWY 01R THR displaced 60(197).				
19L (4)	3560 (11680)	3620 (11876) (1.49%)	3560 (11680)	3560 (11680)
Slope Level. RWY WID 45 RWS WID 300 Graded 150				
14 (3)	1700 (5577)	1760 (5774) (1.6%)	1700 (5577)	1700 (5577)
RWY 14 THR displaced 60(197).				
32 (3)	1700 (5577)	1760 (5774) (1.56%)	1700 (5577)	1700 (5577)

1. RWY 32 THR displaced 60(197).

2. Physical distance between displaced THR is 1640M. Advertised runway length of 1700M

Includes 60M beyond the applicable departure THR.

Slope level. RWY WID 30 RWS 150 Graded 150



3.2.3 Taxiway Intersection Declared Distances

RWY 01R - TKOF from TWY M; RWY remaining 2685 (8809) reduce all DIST by 815 (2674)
RWY 01R - TKOF from TWY A7; RWY remaining 2689 (8822) reduce all DIST by 811 (2661)
RWY 01R - TKOF from TWY A6; RWY remaining 1882 (6174) reduce all DIST by 1618 (5308)
RWY 01R - TKOF from TWY A5; RWY remaining 1412 (4632) reduce all DIST by 2088 (6850)
RWY 01R - TKOF from TWY A4; RWY remaining 1279 (4196) reduce all DIST by 2221 (7287)
RWY 01R - TKOF from TWY A3; RWY remaining 809 (2654) reduce all DIST by 2691 (8829)
RWY 19L - TKOF from TWY H4; RWY remaining 2304 (7559) reduce all DIST by 1256 (4121)
RWY 19L - TKOF from TWY H3; RWY remaining 2774 (9101) reduce all DIST by 786 (2579)
RWY 19L - TKOF from TWY A4S; RWY remaining 1974 (6476) reduce all DIST by 1586 (5203)
RWY 19L - TKOF from TWY A4; RWY remaining 2311 (7582) reduce all DIST by 1249 (4098)
RWY 19L - TKOF from TWY A3; RWY remaining 2781 (9124) reduce all DIST by 779 (2556)

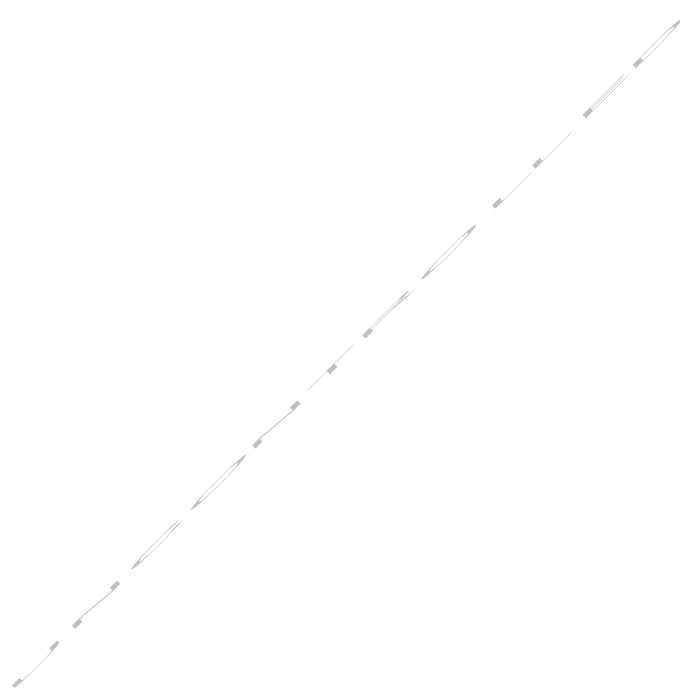

Part 3

Section 3 – Information Visual Aid Systems

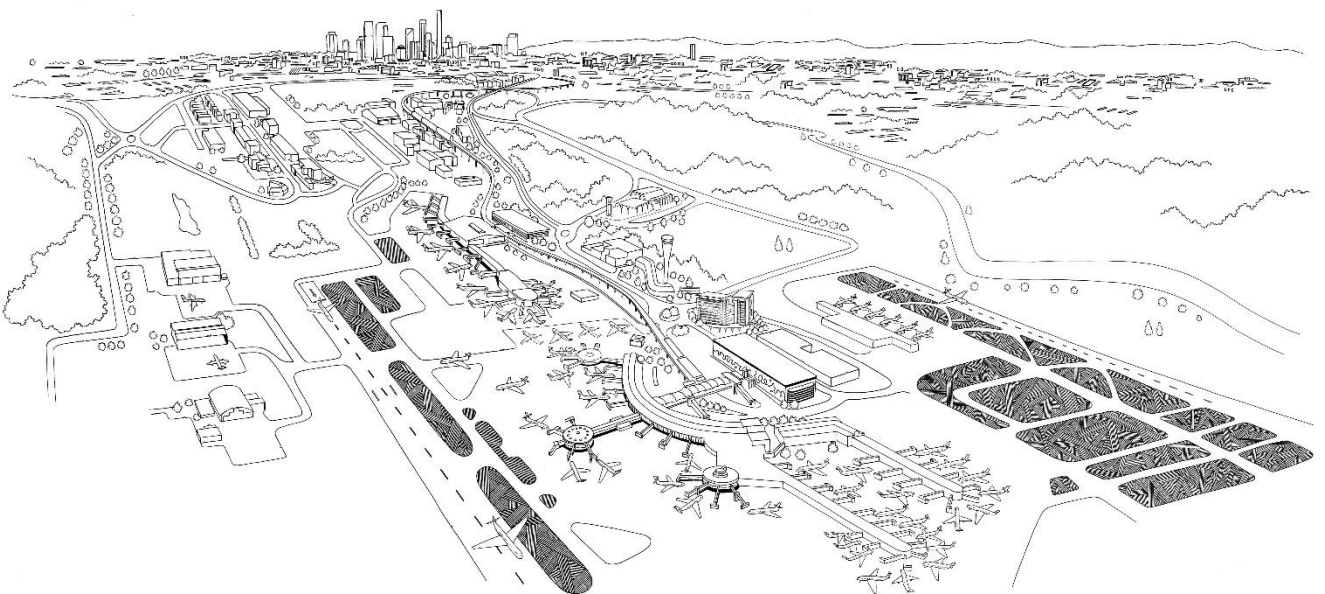



3.3 Information about Visual Aid Systems

To meet the requirements of Appendix 1 to CASR subparagraph 139.095 (a) (ii) this section deals with particulars of the aerodrome visual aid systems including:

- (i) The type of runway lighting and the stand-by power, if any, for that lighting; [also include portable lighting]
- (ii) The type of approach lighting;
- (iii) The visual approach slope indicator system, if any;
- (iv) A description of the visual docking guidance systems at any aprons used by aircraft conducting international operations, and the aircraft parking positions where the systems are installed.

3.3.1 Aerodrome and Approach Lighting

RWY 01R/19L	HIRL		SDBY PWR AVBL
RWY 01R/19L	MIRL		SDBY PWR AVBL
RWY 01R/19L	PAPI (2)	3.0 DEG64FT	SDBY PWR AVBL
RWY 01R/19L	RCLL (1)		SDBY PWR AVBL
RWY 01R	HIAL-CAT I		SDBY PWR AVBL
RWY 01R	RTIL		SDBY PWR AVBL
RWY 19L	HIAL-CAT II		SDBY PWR AVBL
RWY 19L	RTZL		SDBY PWR AVBL
RWY 14/32	MIRL		SDBY PWR AVBL
RWY 14/32	PAPI (2)	3.0 DEG51FT	SDBY PWR AVBL

(1) 15m spacing

(2) Both sides.

ALS Type and Length:

RWY 01R - Distance coded CL: 900M

RWY 19L - Distance coded CL: 900M

RWY edge light spacing:

01R/19L: 60M

14/32: 60M

RGL at all RWY/TWY intersections



3.3.2 Other Lighting

ABN ALTN 8 WG

Secondary PWR switchover time: 1 SEC during LVP; 15 SEC at other times

TWY LGT: Green CL



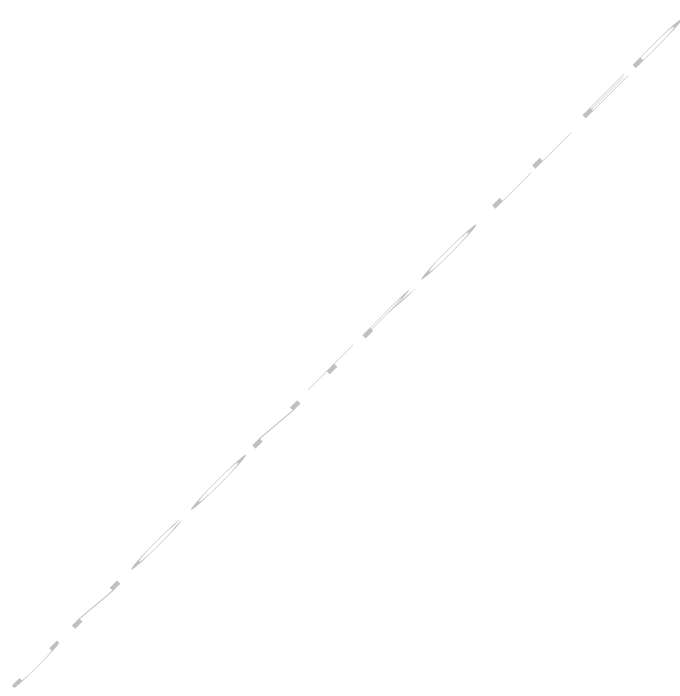

Part 3

Section 4 – Local Information

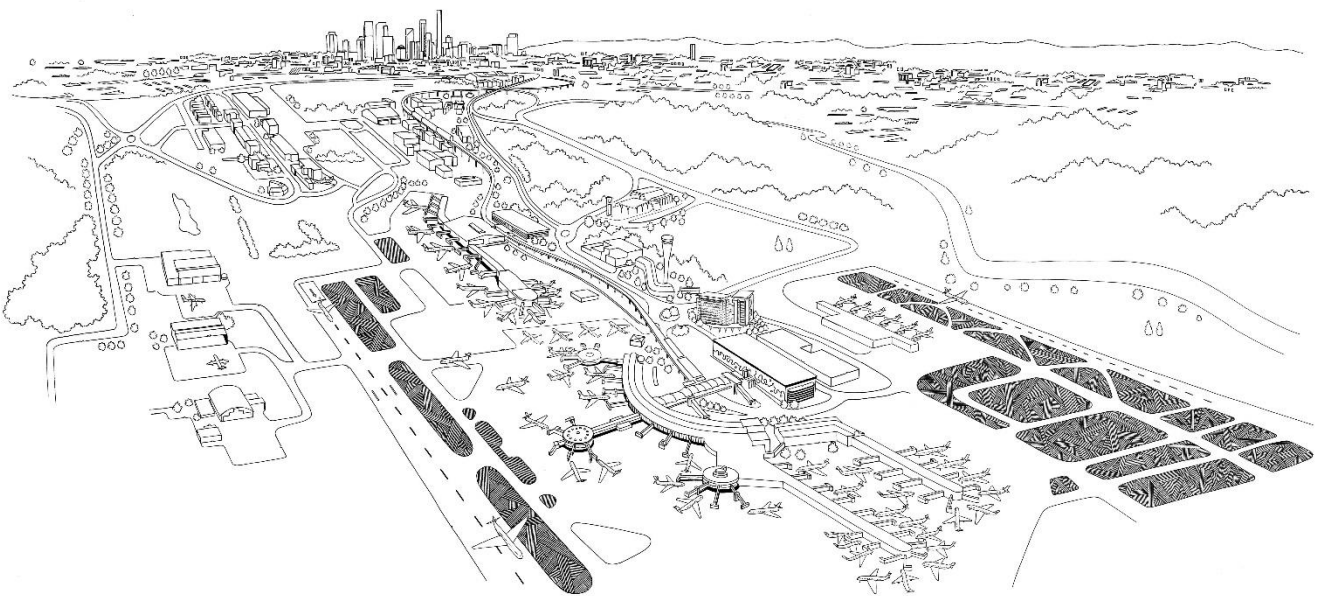



3.4 Local Information

To meet the requirements of Appendix 1 to CASR subparagraph 139.095 (a) (ii) this section deals with particulars of the aerodrome local information including:

- (i) The hours of operation, if applicable;
- (ii) The available ground services;
- (iii) Any special procedures;
- (iv) Any local precautions.

3.4.1 Local Traffic Regulations

Pilots of ACFT LDG RWY 14/32 shall report ' RUNWAY VACATED ' on SMC D FREQ 121.7.

All ACFT ARR and DEP Brisbane (YBBN) are required to operate not ABV 250KT IAS

BLW 10,000FT, unless otherwise directed by ATC, or on pilot request due to ACFT

Operational requirements

HVY ACFT MUST turn right at Bravo 1

Pilots should ensure flight plan details are submitted for flight in Class C airspace associated with Brisbane Approach, preferably through NAIPS or Flight Watch, well in advance of requesting SSR code allocation. Failure to do so will result in delays for airways clearance.

Pilots intending to conduct AWK in the Brisbane TMA must obtain Pre-Flight Briefing and approval from Brisbane TMA - Phone: 07 3866 3694. SVY below 8,000FT can expect operational restrictions.

All aircraft must provide their parked position/gate number to ATC on acknowledgement of airways clearance.

ICAO Chapter 2 ACFT BTN 1200-2000 UTC:

Unless directed otherwise by ATC, at the time of operation, all ICAO Chapter 2 ACFT shall:

- (a) Land RWY 19L
- (b) Take-off RWY 01R
- (c) Take-off RWY 19L NOT permitted.

All TWY: Outboard engines on B747 and A340 ACFT to be operated at low power to prevent TWS erosion and engine ingestion.

TWY A is designed to be used in the same direction as the duty RWY. TWY B is for use in the opposite direction unless otherwise instructed by ATC.

B737 ACFT and ABV not to execute 180DEG turns on RWY 14/32 or RWY 01R/19L.

ACFT parking requests to Duty Terminal Manager H24. See AD OPR for Phone.

ACFT transporting dangerous goods or Livestock require 48 hours notice and prior approval.

B777-300, A340-600 and A380-800 OPS: TWYs associated with RWY 01R/19L are 23M wide (AD REF code 4E). Due excessive ACFT wheelbase, normal TWY safety edge margin not AVBL. Pilots should apply judgemental oversteer when negotiating TWY intersections at B/C9, B/C10 and on INTL Apron. Pilots should request marshalling assistance from a fixed base operator (FBO) if ACFT GND manoeuvring cameras are not AVBL.

Ground running of engines "above idle" requires prior approval. Phone 61 7 3406 3072.



TWY H2N, TWY H2S and TWY M East of the perimeter road designated as apron, are provided for combined ACFT and vehicle TFC FM maintenance hangars. Vehicle TFC under own observation remaining well clear of all taxiing ACFT.

Drains located airside (ADJ the manoeuvring area) are not marked.

Rapid exit TWY A5S not marked with hold point.

ACFT cannot turn from TWY P onto TWY L at TWY J or TWY L on to TWY P at TWY J due to no fillet pavement, turn around loop AVBL for ACFT up to and including B747 on Logistics Apron.

TWYs D, E, F1 and F2 not AVBL for ACFT ABV 66000KG weight and 1475KPA.

Unless OPR requirements the taxi lane between TWY F2 and TWY F4 is not to be used for transiting taxiing ACFT to service RWY 14/32.

TWY Charlie 3 Tango and Apron Taxilane between TWY Charlie 3 and TWY Charlie 4 AVBL to MAX ACFT B737/A321.

Access/Exit GA apron via secured pedestrian gate. Contact signposted on gate.

Rotary wing ACFT using General Aviation (GA) Apron CAUTION MULTIPLE LGT TOWERS 100FT AGL on and surrounding GA Apron.

All rotary wing (helicopter) OPS excluding maintenance activities on TWY H system to be conducted on the GA Apron or Logistics precinct building aprons.

TWY L at TWY P INT reduced wing tip CLR to 7.5M on eastern side of TWY L for A380 (code F) ACFT.

TWY P reduced wing tip CLR to 7.5M on western side for A380 (code F) ACFT.

TWY C4 restricted to MAX A330 ACFT.

HEL touch down/lift on TWY F4 and PRKG area on general aviation APN commissioned.

TWY E BTN TWY E4 & TWY E5 and TWY E5 decommissioned

TWY D BTN TWY B1 and TWY D1 not AVBL HN to northbound TFC. TWY E BTN TWY D and TWY E1 not AVBL HN to northbound TFC.

General Aviation (GA) apron OPS are subject to RWY/apron slot management (refer ERSR Remarks - Section 4.1). ACFT operating on the GA apron are to confirm allocated parking with Brisbane Airport Corporation on 07 3406 3171 prior to arrival.

TWY C6 restricted to MAX B737/A321 (CODE C) ACFT.

TWY F3 not AVBL

For CASA APV operators,

RWY 01R/19L is capable of supporting take-offs with an RVR/RV of not less than 350M

A380 (Code F ACFT) OPS using INTL apron to use TWY C9 & TWY C8 only to INTL apron

A380 compatible bays 71, 72, 73, 74, 75, 76.

TWY C10 and INTL apron Taxilane not AVBL to A380 (Code F ACFT) OPS

All ACFT vacating INTL apron RQ continuous taxi on TWY C9 and TWY C10 using MNM PWR

When RWY 19L is nominated, TWY A4 is not AVBL for arriving ACFT unless directed by ATC



ACFT to use MNM power when entering, exiting and operating on all aprons

RWY 14/32 restrictions - For Code C ACFT ATR72/DHC-8 and ABV: 180 DEG turns only AVBL at turning node end of RWY 32.

TWY M not AVBL to ACFT ABV FLW MAX weight limitations:

A330 154,344KG,	A340 260,063KG,	A350 182,000KG,
A380 321,002KG,	B737 79,000KG,	B747 335,640KG,
B767 141,925KG,	B777 182,242KG,	B787 162,000KG.

TWY H4 RESTRICTED TO B737 / A320 ACFT (CDOE C ACFT) AVBL FOR DASH 8

TEW H3 RESTRICTED TO MAX B777-300ER ACFT (CODE E ACFT)

3.4.2 Training Flights

Circuit training AVBL: 0000-0200 and 0400-0700 UTC.

Bookings required. Phone Brisbane TMA 07 3866 3694^.

Asymmetric training with an ENG shut down is only permitted when a full stop LDG will be made. This PROC shall not be conducted on RWY 01R.

Jet and turbo-prop training and flight test operations not requiring RWY or IAL procedures shall be flight planned in either.

- (i) Low Performance Area (LPA) - within the minor arc BTN 030 and 100 VOR BTN 15 and 30 DME; or
- (ii) High Performance Area (HPA) - within Class C and Class A airspace within the minor arc BTN 040 and 090 VOR BTN 40 and 100 DME BN.

Arriving ACFT may request an IAL for training or licence renewal. The request should be made as early as possible, preferably at flight planning.

IAL (Instrument Approach and Landing) training not available MON-FRI, AVBL SAT 0100-0900, SUN 2300-0600 due to traffic. For other than arriving aircraft, IAL training approval shall be obtained from the National Operations Centre (NOC) Phone: 1800 020 626.

Aircraft conducting a practice instrument approach can expect to make a landing due to traffic management requirements. TWR will advise if traffic disposition allows for a missed approach.

3.4.3 Noise Abatement Procedures

Noise Abatement Procedures (NAP) apply. Refer AIP Departure and Approach Procedures (DAP)

3.4.4 Additional Information

Part of decommissioned (old Eagle Farm) AD, former RWY 04 repainted in yellow, now apron and TWY P of BN AD

Significant bird hazard exists.

- (a) Nankeen Kestrel (birds of prey), peak activity on airfield expected March-July.
- (b) Australian White Ibis flocking on airfield HJ, increased numbers expected February- June.
- (c) Straw Necked Ibis present on airfield HJ, increased numbers expected July-October.
- (d) Flying Fox HN only.



- (e) Cattle Egret present on airfield HJ, increased numbers expected NOV-MAR.
- (f) Increased pelican and cormorant in VCY of AD.

Significant mud wasp ACT WI AD VCY affecting pitot tubes. Pitot tube covers recommended.

Fuel/Oil clean-up/disposal are chargeable and must meet Governmental Environmental standards.

Due to local effects from structural and topographical features the ground winds advised on the ATIS may vary to the wind aloft. Where there is a significant variation reported in these winds, ATC will advise a reported 500FT wind in addition to the aerodrome wind

3.4.5 Charts Related to the Aerodrome

WAC 3340

Aerodrome Obstruction Chart Type A Chart RWY 14/32 - 15th Edition (November 2018);

Aerodrome Obstruction Chart Type A Chart RWY 01R/19L - 15th Edition (November 2018)

Also refer to AIP Departure & Approach Procedures

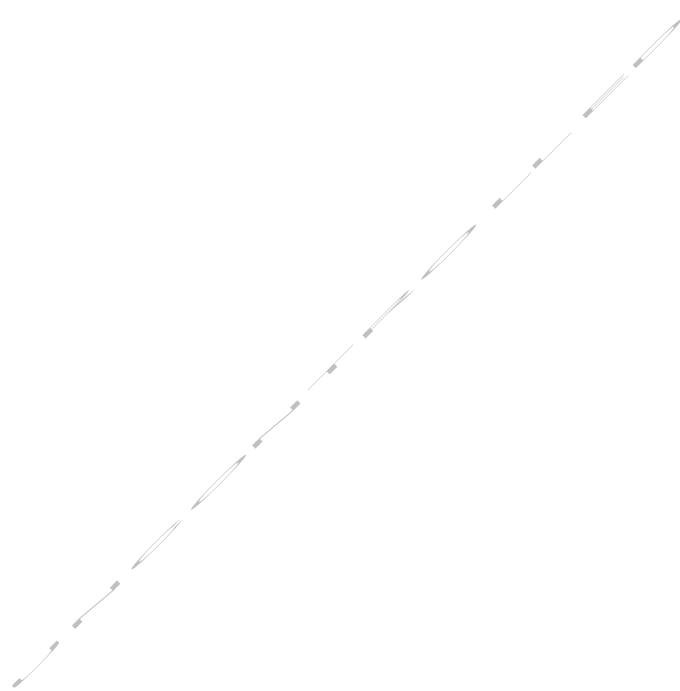

Glossary

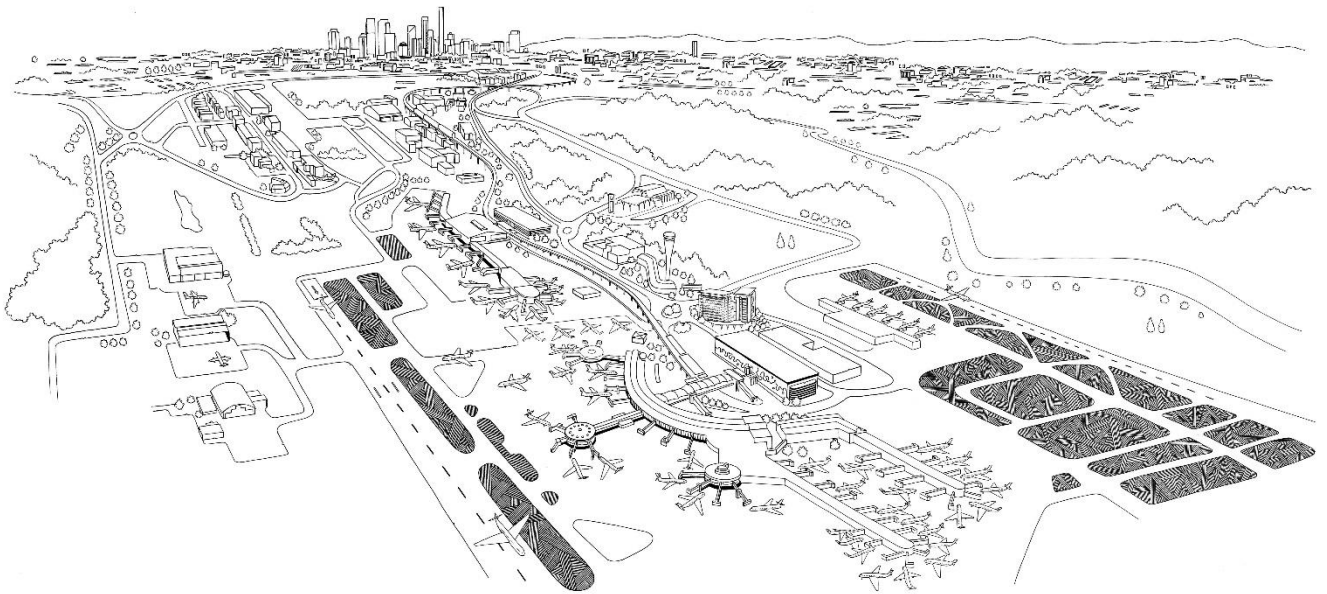

Glossary

This section provides a glossary of words and terms used in the aviation industry and in particular in relation to the operation of airports. Definitions are taken from the;

- *Aviation Transport Security Act 2004,*
- *Aviation Transport Security Regulations 2005,*
- *Transport Safety Investigation Act 2003,*
- *Transport Safety Investigation Regulations 2003,*
- *Civil Aviation Act 1988,*
- *Civil Aviation Safety Regulations 1998 (CASR),*
- *Air Services Act 1995, the Air Services Regulations (ASR),*
- *Airports Act 1996 and the Airports Regulations 1997.*

These are indicated by the use of the hache symbol (#). Those terms marked with an asterisk (*) conform to ICAO definitions.

Aerodrome is the generic term used to describe facilities intended for the landing, take-off and ground movement of aircraft. A Commonwealth-owned aerodrome leased to an airport-lessee company such as BAC under the provisions of the *Airports Act 1996* is defined as an airport for the purposes of that Act. In using this glossary, the two terms should be considered interchangeable.

A

accelerate-stop distance available (ASDA): See "declared distances".

accident: An occurrence associated with the operation of an aircraft in which:

- any person suffers death or serious injury as a result of being in, or in direct contact with the aircraft;
- the aircraft sustains damage or structural failure that adversely affects the structural strength, performance or flight characteristics of the aircraft, and would normally require major repair or replacement of the affected component; or
- the aircraft is missing or inaccessible.

Advisory Circular (AC): Advisory documents issued by CASA suggesting preferred methods for complying with the CASR. The advice contained in the AC is meant to

be read in conjunction with the CASR and Manual of Standards.

aerodrome: A defined area on land or water (including any buildings, installations, and equipment) intended to be used either wholly or in part for the arrival, departure and surface movement of aircraft.*

An area of land or water (including buildings, installations and equipment), the use of which as an aerodrome is authorized under the regulations, being such an area intended for wholly or partly for the arrival, departure or movement of aircraft.#

aerodrome beacon: A light, visible intermittently at all azimuths, used to indicate the location of an aerodrome from the air. It comprises a rotating light, usually producing alternate white and green flashes, visible up to 50 nautical miles in clear conditions.

aerodrome chart: A pictorial representation of the airport layout and immediate environs published in AIP-DAP, showing runways, taxiways, aprons, air



navigation aids, prominent obstacles and obstacle lighting, approach lighting, airport lighting, threshold elevations and visual aids. Also known as a landing chart.

aerodrome control service: ATC service for aerodrome traffic.

aerodrome control tower: A unit established to provide ATC service to aerodrome traffic.

aerodrome diagrams (ADDGM): See "Enroute Supplement Australia (AIP-ERSA)".

aerodrome manual: A manual required for a certified airport under CASR Part 139 which sets out, in an approved form, airport particulars and operating procedures. Appendix 1 to CASR subparagraph 139.095(a)(ii) gives details of particulars to be included in the manual. (Also known as the Operations Manual)

aerodrome meteorological minima (ceiling and visibility minima): The minimum heights of cloud base (ceiling) and minimum values of visibility as prescribed in pursuance of the CAR 257 for the purpose of determining whether an aerodrome may be used either for take-off or landing.#

aerodrome obstacle chart - Type A (AOC - Type A): One of a range of aeronautical charts specified in ICAO Annex 4, intended for use by aircraft operators in determining operational procedures which are necessary in order to comply with obstacle clearance requirements on take-off, as specified by CASA.

aerodrome operating minima: The limits of usability of an aerodrome for either take-off or landing, usually expressed in terms of visibility or runway visual range, decision altitude/height (DA/H) or minimum descent altitude/height (MDA/H) and cloud conditions.*

aerodrome reference code: A two element alpha-numeric code based on aeroplane reference field length and wing span or outer main gear wheel span. The code is used to determine the physical characteristics of an airport facility in relation to the performance characteristics and physical dimensions of an aeroplane.

aerodrome reference point (ARP): The designated geographical location of an aerodrome.* This is fixed as near as possible to the geometric centre of the aerodrome taking into account possible future development. The location is given to the nearest second of latitude and longitude.

aerodrome reference temperature: The declared temperature for a particular aerodrome. It is the monthly

mean of the daily maximum temperatures for the hottest month of the year, averaged over a **period** of years, expressed in degrees Celsius.

aeronautical beacon: An aeronautical ground light visible at all azimuths, either continuously or intermittently, to identify a particular point on the surface of the earth.*

aeronautical chart: A representation of portion of the earth, its culture and relief, specifically designated to meet the requirements of air navigation.*

aeronautical fixed telecommunication network (AFTN): An integrated world-wide system of aeronautical fixed circuits - part of the aeronautical fixed service (AFS) - for the exchange of messages between stations within the network.

aeronautical ground light: Any light specifically provided as an aid to air navigation, other than a light displayed on an aircraft.*

aeronautical information circular (AIC): A notice containing information that does not qualify for the origination of a NOTAM or for inclusion in the AIP, but which relates to flight safety, air navigation, technical, administrative or legislative matters.* An AIC gives advance notice of facilities, services and procedures of a temporary nature.

aeronautical information publication (AIP): A publication issued by or with the authority of a State and containing aeronautical information of a lasting nature essential to air navigation.* The AIP for Australia and its Territories is published under Section 8 of the *Air Services Act 1995*.

aeronautical information publication supplements (SUP): AIP Supplements are issued whenever information is of a temporary nature and requires advance distribution or is appropriate to the AIP but would not be made available quickly enough by the issue of an amendment to the AIP.

aeronautical information regulation and control (AIRAC): A system (and associated NOTAM) aimed at advance notification based on common effective dates, of circumstances that necessitate changes in operating practices.

aeronautical information service (AIS): A service provided by AA to collect, collate, edit and publish aeronautical information.

aeronautical services: Services and facilities in relation to:

- aircraft landings, take-offs and parking, including the provision of:
- runways, taxiways, parking aprons and associated lighting;
- airside roads and grounds, and associated lighting;
- maintenance and repair services in relation to runways, taxiways, and parking aprons;
- rescue, fire-fighting and safety services;
- environmental-hazard-control services;
- services and facilities to ensure compliance with environmental laws; and
- airfield navigation services, including nose-in guidance and visual navigation aids.
- the embarkation or disembarkation and temporary accommodation of passengers, including the provision to passengers of:
- toilets, seating, thoroughfares, transfer systems and aerobridges;
- departure lounges and holding lounges;
- flight-information and public-address systems;
- facilities to permit the operation of terminal security services;
- the administrative processing of passengers, including the provision to passengers of:
- facilities to enable the operations of customs, immigration and quarantine services;
- passenger check-in facilities;
- landside terminal access roads, lighting and covered walkways;
- baggage handling services; and
- facilities to enable the operation of baggage security services.

aeroplane: A power driven, heavier-than-air aircraft deriving its lift in flight chiefly from aerodynamic reactions on fixed surfaces which remain fixed under given conditions of flight.#

aeroplane flight manual: A manual with the certificate of airworthiness containing details of limitations within which the aeroplane is to be considered airworthy, and instructions and information necessary for flight crew members for the safe operation of the aeroplane.

aeroplane operating weight: The weight of the aeroplane together with the weight of all persons, goods and fuel on board at the time.

aeroplane reference field length (ARFL): The minimum field length required for take-off at maximum certified take-off mass, sea level, standard atmospheric conditions, still air and zero runway slope, as shown in the appropriate aeroplane flight manual prescribed by the certifying authority or equivalent data from the aeroplane manufacturer. Field length means balanced field length for aeroplanes, if applicable, or take-off distances in other cases.*

aircraft: Any machine or craft that can derive support in the atmosphere from the reactions of the air, other than the reactions of the air against the earth's surface. #

aircraft avionics: A term designating any electronic device (including its electrical part) for use in an aircraft, including radio, automatic flight control **and** instrument systems.*

aircraft classification number (ACN): A number expressing the relative effect of an aircraft on a pavement for a specific standard of subgrade strength.*

aircraft category: Classification of aircraft according to specified basic characteristics, e.g. aeroplane, glider, rotorcraft, free balloon.*

aircraft identification: A group of letters, figures or a combination thereof which is either identical to, or the coded equivalent of the aircraft call sign to be used in air-ground communications, and which is used to identify the aircraft in air traffic services communications.*

aircraft parking bay: A designated (by number and/or letter) parking position on an apron.

aircraft speed categories: In instrument approach to land procedure design, landing minima are determined by aircraft speed at the runway threshold:

- **category A** - speeds up to 90 knot IAS;
- **category B** - speeds from 91 to 120 knots IAS;
- **category C** - speeds from 121 to 140 knots IAS;



- **category D** - speeds from 141 to 165 knots IAS; and
- **category E** - speeds from 166 to 210 knots IAS.

aircraft stand: A designated area on an apron intended to be used for parking an aircraft with aircraft positions not designated.

aircraft stand taxiway: See "taxiway".

aircraft weight categories: For the purpose of wake turbulence separation aircraft are divided into the following weight categories:

- **heavy (H)** - aircraft of 136 000 kg MTOW or more;
- **medium (M)** - aircraft less than 136 000 kg MTOW but more than 7 000 kg MTOW;
- **light (L)** - aircraft of 7 000 kg MTOW or less.

air-ground communications: Two way communication between aircraft and stations or locations (fixed or mobile) on the surface of the earth.*

airline: The operator of a regular public transport air service. # A person who carries on a commercial air transport enterprise that involves offering or operating scheduled or chartered air services. #

air navigation aid (navaid): A ground based or airborne facility or equipment relying primarily on the transmission/reception of radio or radar signals to provide information used to determine the location of an aircraft. Nav aids are designed to be used either for en-route navigation or to assist in approach and landing in reduced visibility conditions.

air operators certificate (AOC): A certificate issued under section 27 (of the *Civil Aviation Act 1988*).#

airport: See "aerodrome".

airport elevation: The elevation of the highest point of the landing area.* It is based on the Australian Height Datum 1971 and quoted to the nearest foot.

airport emergency plan (AEP): A plan developed by the airport operator to coordinate all agencies and their individual airport emergency procedures, and State or supporting area plans for dealing with an airport emergency.

airport emergency procedures (standard operating procedures): Individual agency procedures for meeting the AEP.

airport operations manual: See "aerodrome manual".

airport lighting: See "approach lighting", "movement area lighting" and "obstacle lighting".

airport operator: Any owner, licensee, Authority, Corporation, or any other body which has a legal responsibility for a particular aerodrome.

airport reporting: Notification to AA of any changes in movement area condition, other defects in airport facilities or equipment, or new obstacles that may affect the safety of airport/aircraft operations. See also "airport serviceability inspection" and "reporting officer."

airport safety inspection: Applies to a registered aerodrome. It consists of a comprehensive check of airport facilities, equipment, OLS, and published information, together with an assessment of airport operating procedures, carried out by a person approved by CASA, and designed to provide an annual assurance that the airport is being maintained and operated in accordance with relevant CASA standards.

airport safety inspection report: The report compiled and submitted to CASA within 30 days of completing the airport safety inspection.

airport safety inspector (ASI): A person approved by CASA and is thereby deemed eligible to carry out, or direct, the annual safety inspection.

airport serviceability inspection: Regular visual checks of the movement area, day and night ground aids, the OLS, bird activity and boundary fences, to confirm that the airport and its immediate airspace are serviceable and safe for aircraft operations. The inspection includes a check of current NOTAM to ensure that information made available to pilots is relevant and accurate. Serviceability inspections are usually programmed daily, but may be carried out more or less frequently, depending on the nature of airport/aircraft operations. See also "reporting officer" and "airport reporting".

airport technical inspection: Operators of certified aerodromes must arrange for an annual technical inspection(s) of airport facilities, equipment and OLS conducted by appropriately qualified technical staff. They are essentially diagnostic in nature and intended to detect potentially unsafe conditions that may be overlooked in a serviceability inspection.



airport traffic: All traffic on the maneuvering area and all aircraft flying in the vicinity of an aerodrome. An aircraft is in the vicinity of the aerodrome when it is in, entering or leaving the traffic circuit.

airport traffic zone: An airspace of defined dimensions established around an aerodrome for the protection of aerodrome traffic.

airport works: Any construction or maintenance works carried out on or adjacent to the movement area that may create obstacles or restrict the normal take-off and landing of aircraft.

airport-lessee company: A company that holds an airport lease (of a Commonwealth-owned airport).# See "airport operator" and "airport-operator company".

airport-operator company: See "airport-lessee company".

Airports Regulations: Regulations made by the Governor-General under the *Airports Act 1996*.

Airports (Building Control) Regulations: Regulations made by the Governor-General under the *Airports Act 1996*.

Airports (Control of On-Airport Activities) Regulations: Regulations made by the Governor-General under the *Airports Act 1996*.

Airports (Environment Protection) Regulations: Regulations made by the Governor-General under the *Airports Act 1996*.

Airports (Ownership – Interests in Shares) Regulations: Regulations made by the Governor-General under the *Airports Act 1996*.

Airports (Protection of Airspace) Regulations: Regulations made by the Governor-General under the *Airports Act 1996*.

air route: The navigable airspace between two points and the terrain beneath such airspace identified, to the extent necessary, for application of flight rules. #

air route and airways facilities: Facilities provided to permit safe navigation of aircraft within the airspace of air routes and airways, including;

- visual and non-visual aids along the air routes and airways;
- visual and non-visual aids to approach and landing at aerodromes;

- communication services;
- meteorological observations;
- air traffic control services and facilities; and
- flight service facilities.

air service: Any scheduled air service performed by aircraft for the public transport of passengers, mail or cargo.*

airside: The movement area of an aerodrome, adjacent terrain and buildings or portions thereof, access to which is controlled.*

airspace: That portion of the earth's atmosphere over which a nation exercises jurisdiction over aircraft in flight. The continental division of airspace usually coincides with the national boundaries and the oceanic division is determined by mutual agreement of the nations concerned. See also "controlled airspace".

air taxiing: Airborne movement of a helicopter at low ground speed and at heights normally associated with ground effect.

air taxiway: A defined path on the surface established for the air taxiing of helicopters.#

air traffic: All aircraft in flight or operating on the maneuvering area of an airport.

air traffic control (ATC): A service established by Airservices Australia pursuant to section 8 of the *Air Services Act 1995*. ATC functions are chiefly to prevent collisions between aircraft (and on the maneuvering area, between aircraft and obstructions), and to expedite and maintain an orderly flow of air traffic.

air traffic control service: A service provided by ATC which includes a traffic advisory service, traffic avoidance advice or airport control service.

air traffic services (ATS): ATC service, flight information service and SAR alerting service.

air transit: The airborne movement of a helicopter:

- for the expeditious transit from one place to another within an aerodrome,
- at or below 100 feet above the surface; and
- at speeds greater than those used to air taxi.

air transit route: A defined path on the surface established for the air transiting of helicopters.*



airway: A control area or portion thereof established in the form of a corridor equipped with radio navigation aids.* A designated path in an air route identified by an area of specified width on the surface of the earth.#

airway facilities: All facilities provided to permit safe navigation of aircraft within airways which includes visual and non-visual navigation aids along the airways, and in approach and landing areas, together with meteorological, communication and air traffic services. See also "air route and airway facilities".

airways clearance: A clearance issued by ATC to operate in controlled airspace along a designated track or route at a specified level to a specified point or flight plan destination.*

alternate (aerodrome): An aerodrome specified in the flight plan to which a flight may proceed when it becomes inadvisable to land at the aerodrome of intended landing.*

altimeter setting: A pressure datum, which when set on the sub-scale of a sensitive altimeter causes the altimeter to indicate vertical displacement from that datum. A pressure type altimeter calibrated in accordance with standard atmosphere may be used to indicate altitude, height or flight levels, as follows:

- when set to QNH or area QNH it will indicate altitude;
- when set to QFE it will indicate height above the QFE datum; and
- when set to standard pressure (1013.2 hPa or mb) it may be used to indicate flight levels.

altitude: The vertical distance of a level, a point, or an object considered as a point, measured from mean sea level.* In accordance with international civil aviation practices, altitude is measured in feet. The letter "A" followed by three figures denotes a specific altitude, e.g. A060 is 6000 feet AMSL.

ambient conditions: Atmospheric temperature, pressure and wind conditions prevailing at the time.

anemometer: A device for detecting and indicating wind speed and direction.

approach and departure path: The track of a helicopter as it approaches, or takes off and departs from, the FATO of a HLS.

approach area: A defined portion of land or water, quadrilateral in shape, at the end of the runway strip, and defined by the vertical projection of the approach

surface. This is an area within which it may be necessary to restrict the creation of new obstacles or remove or mark existing obstacles in order to ensure a satisfactory level of safety for aircraft operations during the approach phase of flight.

approach clearance: Permission granted by ATC for an IFR flight to commence an instrument approach to an airport.

approach control service: An ATC service for arriving or departing flights of aircraft.**

approach lighting: A centreline and crossbar pattern of lights extending 1 000 metres prior to the runway threshold providing visual guidance in the final stage of descent when using the instrument landing system.

approach sequence: The order in which two or more aircraft are cleared to approach to land the airport.

approach surface: See "obstacle limitation surfaces (OLS)".

approach survey: An instrument survey of the approach and take-off climb surfaces to determine:

- gradient from the end of the clearway to the critical obstacle(s);
- declared distances based on the critical obstacle(s);
- required location of runway thresholds;
- extent of infringements by obstacles that may be economically removed;
- gradients and declared distances that would result from the removal of such infringements; and
- integrity of the transitional surfaces.

apron: A defined area on a land aerodrome intended to accommodate aircraft for the purposes of loading and unloading passengers, mail or cargo, fuelling, parking or maintenance.* That part of an aerodrome to be used:

- for the purpose of enabling passengers to board, or disembark from, aircraft;
- for loading cargo on to, or unloading cargo from, aircraft; and/or
- for refuelling, parking or carrying out maintenance on aircraft. #



apron management service: A service provided to regulate the activities and the movement of aircraft and vehicles on the apron.*

apron taxiway: See "taxiway".

area control centre (ACC): A unit established to provide area control service.

area QNH: A forecast altimeter setting which is representative of the QNH of any location within a particular area.

assembly area: A prearranged, strategically located area on or off airport where responding agencies and their vehicles can be assembled in order to be escorted onto the airport during an emergency.

Australian height datum (AHD): A homogeneous levelling network covering the whole of the Australian mainland, which is based on the mean sea level at 31 tide gauges around the Australian coastline. This datum was adopted by the National Mapping Council in 1971 and provides a standard, accurate levelling reference for scientific, mapping and engineering purposes. AHD does not include Tasmania which has its own height datum.

Australian noise exposure concept (ANEC): A plan produced using the noise exposure system to show the effect of a hypothetical set of conditions for runways, aircraft types, etc. It may be a supposition for a long way into the future and may never occur.

Australian noise exposure forecast (ANEF): A plan produced using the noise exposure system to depict the expected worst case forecast for airport noise levels.

Australian noise exposure forecast (ANEF) system: The method used in Australia for the assessment of aircraft noise in the vicinity of airports and for land use planning in relation to that noise. The ANEF is a single number index for predicting the cumulative exposure to aircraft noise in communities near airports during an average day. An ANEF plan is a map showing noise contours plotted for 20, 25, 30, 35 and 40 ANEF units. Compatible land uses are defined for each ANEF zone.

Australian noise exposure index (ANEI): A plan produced using the noise exposure system and historical data from a previous year to show the actual daily aircraft noise exposure around the airport for that year.

Australian NOTAM office: See "international NOTAM office."

authorised person: A person authorised under CAR 6 to undertake inspections or action as stated in the CASR.

automatic direction finding (ADF): An airborne radio navigation aid providing the relative bearing between the aircraft heading and a NDB or broadcasting station. It is also known as a radio compass.

automatic terminal information service (ATIS): The provision of current, routine information to arriving and departing aircraft by means of continuous and repetitive broadcasts.

autorotative flight: A condition of flight without power in a rotary winged aircraft when lift is derived from airflow upwards through the rotor system.

autorotative landing: A landing in a rotary winged aircraft, without power, following autorotative flight.

auxiliary power unit (APU): A self-contained power unit on an aircraft providing electrical/pneumatic power to aircraft systems during ground operations.*

aviation security: A combination of measures and human and material resources intended to safeguard aviation against unlawful interference.#

azimuth aid: An air navigation aid providing directional guidance.

B

barrette: Three or more aeronautical ground lights closely spaced in a transverse line so that from a distance they appear as a short bar of light.*

balked landing surface: See "obstacle limitation surfaces (OLS)".

bird hazard: The risk to the safety of aircraft operations caused by the presence of birds on or in the vicinity of an airport.

bird hazard management: A combination of measures and human and material resources intended to minimise or, if possible, eliminate bird hazards to aircraft.

Bird strike: A collision between a bird and an aircraft.

blast protection area: An area, usually adjacent to the end of a runway, which has been treated to prevent erosion from jet and propeller blast.



brakes release point (BRP): See "start of take-off (SOT)".

Brisbane Airport Corporation Pty Ltd (BAC): the airport-lessee and airport-operator company for Brisbane Airport.

building area: An area on an airport, outside the movement area, allocated for the provision of administration, aircraft maintenance and passengers, freight, fuel depots or other facilities.

building line: The line of demarcation between the movement area and the building area.

C

cargo: Any property carried on an aircraft other than mail, stores and baggage.* Things other than passengers carried in aircraft.#

casualty processing area: The area where medical staff assemble to provide triage treatment and arrange transportation to hospital for those persons injured in an airport emergency.

ceiling: The height above ground or water of the base of the lowest cloud layer below 20,000 feet and covering more than one-half of the sky.

certificate of airworthiness (Cof A): A certificate issued for an aircraft which complies with current airworthiness requirements after being inspected, overhauled, repaired or modified. The issue of a Cof A in Australia is covered by CASR Part 21.

certified aerodrome: An aerodrome whose operator has been granted a certificate under CASR Part 139.

channel: That part of a water aerodrome which is navigable and cleared for the safety of aircraft taking-off or landing in a given direction.

charter operations: Those types of aircraft operations specified in the CASR, which generally include the carriage of passengers or cargo for hire or reward, but excluding regular public transport operations.

Chicago Convention: The Convention of International Civil Aviation concluded at Chicago on 7th December 1944. It includes the international standards and recommended practices and procedures adopted by the International Civil Aviation Organisation in pursuance of Article 37 of the Convention.

circling approach: An extension of an instrument approach procedure which provides for visual circling of the airport prior to landing.

Civil Aviation Advisory Publications (CAAP): Advisory documents previously issued by CASA suggesting preferred methods for complying with the CAR. They are being replaced with Advisory Circulars.

Civil Aviation Orders (CAO): Orders issued by the (Civil Aviation Safety) Authority under (Civil Aviation) Regulation 5.#

Civil Aviation Safety Regulations (CASR): Regulations made by the Governor-General under the *Civil Aviation Act 1988*.

clearance surfaces: See "obstacle limitation surfaces (OLS)".

clearway: A defined rectangular area on the ground or water at the end of the runway in the direction of take-off and under the control of the ...(airport operator)..., selected and prepared as a suitable area over which an aeroplane may make a portion of its initial climb to a specified height.*

clear zone: An open area beyond the end of the clearway, intended as a buffer zone to prevent the airport and the surrounding community from adversely affecting each other in respect of noise, airport operations and development.

combat agency: The agency primarily responsible for responding to a specified or potential airport emergency.

commercial operation: An air operation other than a private operation.#

common traffic advisory frequency (CTAF): A frequency for pilots to exchange traffic information while operating to or from an airport without an operating control tower, or within a designated area. Where established a CTAF will be shown in ERSA-FAC.

conical surface: See "obstacle limitation surfaces (OLS)".

control area (CTA): A controlled airspace extending upwards from a specified height above the surface of the earth.* It is an airspace of defined dimensions in which operations must be conducted in accordance with published procedures, requirements and ATC clearances.

control zone (CTR): A controlled airspace extending upwards from the surface of the earth to a specified



upper limit.* It is an airspace of defined dimensions surrounding controlled aerodromes and within which operations must be conducted in accordance with published procedures, requirements and ATC clearances.

controlled activities: In relation to prescribed airspace are:

- constructing or altering a building or other structure so that it intrudes into the prescribed airspace; and
- any other activity that causes something which is attached to, or in contact with, the ground to intrude into the prescribed airspace.

controlled aerodrome: An aerodrome at which ATC service is provided to aerodrome traffic.*

controlled airspace: Airspace of defined dimensions within which ATC service is provided to controlled flights.* A control area or control zone.#

convention: See "Chicago Convention".

coordinated universal time (UTC): The international time standard used for civil aviation. A ten figure date and time group comprising the year, month, day, hours and minutes is used for NOTAM and AIP supplements, e.g. 9706301400. UTC is derived from Eastern Standard Time (EST) by subtracting 10 hours.

critical aircraft: The most critical aircraft that an airport can accommodate in respect of operational, pavement strength or other relevant limitations. Taxi guideline markings may also determine a critical aircraft if turning characteristics limit its manoeuvring. There may be a different critical aircraft for each airport facility.

critical obstacle: The obstacle within the take-off climb area and/or approach area, which subtends the greatest vertical angle when measured from the inner edge of the take-off climb/approach surface.

crosswind component: The surface wind component at right angles to the runway centreline.

crosswind shear: A wind shear occurrence which requires a rapid change in aircraft heading to maintain track.

cruising level: In relation to an aircraft, the height above ground or water, or above an atmospheric datum, at which the aircraft flies when it is not climbing or descending.#

culture: All features constructed on the surface of the earth by man, such as cities, railways, canals, etc.*

D

danger area: An airspace of defined dimensions within which activities dangerous to the flight of aircraft may exist at specified times.*

dangerous goods: See "hazardous materials".

dangerous lights: Any lights which may endanger the safety of aircraft, whether by their glare or by causing confusion with or preventing clear visual reception of aeronautical lights or signals. #

declared distances: The operational lengths of the runway associated with take-off and landing of aeroplanes:

- **take-off run available (TORA)** - the length of the runway declared available and suitable for the ground run of an aeroplane taking off;
- **take-off distance available (TODA)** - the length of the TORA plus the length of the clearway, if provided;
- **accelerate-stop distance available (ASDA)** - the length of the TORA plus the length of stopway, if provided;
- **landing distance available (LDA)** - the length of the runway which is declared available and suitable for the ground run of an aeroplane landing.*

declared distances - heliports: Operational distances associated with the take-off and landing of helicopters:

- **take-off distance available (TODAH)** - the length of the final approach and take-off area plus the length of helicopter clearway, if provided, declared available and suitable for helicopters to complete the take-off;
- **rejected take-off distance available (RTODAH)** - the length of the final approach and take-off area plus any additional area declared available and suitable for performance Class 1 helicopters to complete a rejected take-off; and



- **landing distance available (LDAH)** - the length of the final approach and take-off area plus any additional area declared available and suitable for helicopters to complete the landing manoeuvre from a defined height.*

decision altitude/height (DA/H): A specified altitude or height in the precision approach at which a missed approach must be initiated if the required visual reference to continue the approach to land has not been established. Decision altitude is referenced to mean sea level (MSL) and decision height is referenced to the threshold elevation. The required visual reference means that section of the visual aids or of the approach area which should have been in view for sufficient time for the pilot to have made an assessment of the aircraft position and rate of change of position in relation to the desired flight path.*

density height: An atmospheric density expressed in terms of height which corresponds to that density in the standard atmosphere.

departure and approach procedures (DAP): An aeronautical information publication (AIP-DAP) which contains aerodrome/landing charts, instrument approach and landing procedures, standard instrument departures, DME or GPS arrivals and noise abatement procedures.

displaced threshold: A threshold not located at the extremity of a runway.*

distance measuring equipment (DME): An airborne radio navigation aid providing an indication of distance to a selected ground beacon.

domestic flight: A flight between two points within Australia.

E

effective intensity: The intensity of a flashing light which is equal to the intensity of a fixed light of the same colour which will produce the same visual range under identical conditions of observation.*

elevated heliport: A heliport located on a raised structure on land.*

elevation: In relation to flight, means the vertical distance of a point or a level on or affixed to the surface of the earth, measured from mean sea level.* For the purposes of aeronautical information, the measurement

of altitude, elevation and height is expressed in units of feet.

emergency/disaster: An emergency due to an actual or imminent occurrence which:

- endangers, or threatens to endanger, the safety or health of persons; and
- destroyed or damaged, or threatens to destroy or damage, property.

emergency coordination centre (ECC): A fixed location established on or near the airport used as a centre for coordination and communication during an emergency.

emergency operations centre (EOC): See "emergency coordination centre (ECC)".

Enroute Supplement Australia (ERSA): This AIP supplement (AIP-ERSA) is a joint military/civil publication containing the aerodrome and facility directory for military aerodromes and civil public aerodromes. ERSA contains aerodrome diagrams (ADDGM) and other information such as physical characteristics, visual ground aids, aeronautical lights, MTAF and CTAF boundaries. ERSA itself has a separate Runway Distances Supplement which provides declared distances information for each airport.

equivalent single isolated wheel load (ESIWL): The equivalent load that would be imposed on a pavement by a single wheel if any wheel group on an aircraft was replaced by a single wheel using the same tyre pressure.

F

final approach: That part of an instrument approach procedure from the time the aircraft has:

- completed the last procedure turn, if one is specified; or
- crossed a specified fix; or
- intercepted the last track specified for the procedure; and
- until it has crossed a point in the vicinity of the airport from which a landing can be made or a missed approach procedure is initiated.



final approach altitude: The specified altitude at which final approach is commenced.

final approach fix (FAF): That fix or point of an instrument approach procedure where the final approach segment commences.*

final approach segment: That segment of an instrument approach procedure in which alignment and descent for landing are accomplished.

final approach and take-off area (FATO): A defined area over which the final phase of the approach manoeuvre to hover or landing is completed and from which the take-off manoeuvre is commenced and, where the FATO is to be used by performance Class 1 helicopters, includes the rejected take-off area available.*

final leg: The path of an aircraft in a straight line immediately preceding the landing (alighting) of the aircraft.

fix: A geographical position of an aircraft at a specified time determined by visual reference to the earth's surface, or by navigation aids.

fixed light: A light having constant luminous intensity when observed from a fixed point.*

flight (heavier-than-air aircraft): The operation of the aircraft from the moment at which the aircraft first moves under its own power for the purpose of taking off until the moment at which it comes to rest after being airborne.#

flight (lighter-than-air aircraft): The operation of the aircraft from the moment it becomes detached from the surface of the earth or from a fixed object until the moment when it becomes again attached to the surface of the earth or a fixed object on the surface of the earth.#

flight information: Information which may assist a pilot in the planning and progress of a flight, including information on air traffic, meteorological conditions, aerodrome conditions and air routes.

flight information area (FIA): An airspace of defined dimensions, excluding controlled airspace, within which flight information and SAR alerting services are provided by an ATS unit.

flight information centre (FIC): A unit established to provide flight information and SAR alerting services.*

flight information region (FIR): An airspace of defined dimensions within which a flight information and SAR alerting service are provided.

flight information service (FIS): A service provided by an ATS unit for the purpose of giving advice and information useful for the safe and efficient conduct of flights.

flight level (FL): A surface of constant atmospheric pressure which is related to a specific pressure datum of 1013.2 hPa or mb and is separated from other such surfaces by specific pressure intervals. Flight level zero (FL 0) is the level at which the atmospheric pressure is 1013.2 hPa or mb and consecutive flight levels are separated by intervals of 500 feet (e.g. FL 5, 10, 15, etc.). In Australia, flight levels are applied only above FL 110. Below this, altitudes are used, i.e. heights related to sea level with the altimeter set to the area atmospheric pressure (QNH) at the time.

flight path: The airspace connecting two locations and surrounding the actual or proposed track of the aircraft.

flight plan: Specified information provided to ATS units, relative to an intended flight or portion of a flight of an aircraft.*

flight service: A service established by the Airservices Australia pursuant to section 8 of the *Air Services Act 1995*.#

flight services: Air-ground communication services, flight information services and SAR alerting services provided by ATS units.

flight service unit (FSU): An AA unit providing flight services.

flying school: A school for which there is an Air Operator's Certificate that authorises the school to conduct flying training. #

flying training area: In relation to an aerodrome, an area that is:

specified in a flying training school's operations manual as the flying training area for the aerodrome; and

designated by Airservices Australia as a flying training area.

forward command post (FCP): In relation to an emergency, the point where cooperating agency heads assemble to receive and disseminate information and make operational decisions on the



immediate rescue operation. Also known as **site control**.

frangibility: A characteristic of an object to retain its structural integrity and stiffness up to a desired maximum load, but on impact from a greater load, to break, distort or yield in such a manner as to present the minimum hazard to aircraft.*

fuelling installation: A fixed facility for the reception, storage and distribution of liquid fuels for the fuelling of aircraft or ground vehicles.

fuel tanker: A mobile fuel dispenser fitted out in accordance with CAO 20.9.

full emergency: A situation in which the response of all agencies involved in the AEP will be activated. A full emergency will be declared when an aircraft approaching the airport is known or suspected to be in such trouble that there is danger of an accident. The level of emergency declared depends on the category of aircraft:

- **Level I** up to 18 seats (ATC reference light);
- **Level II** up to 215 seats (ATC reference medium); and
- **Level III** over 215 seats (ATC reference heavy).

G

general aviation (GA): All civil aviation operations other than RPT operations.

glide path (GP): A descent profile determined for vertical guidance during a final approach* or that component of an ILS or MLS which provides vertical guidance to a runway.

glider: A non-power-driven heavier-than-air aircraft, deriving its lift in flight chiefly from aerodynamic reactions on surfaces which remain fixed under given conditions of flight.*

gross weight: The weight of an aircraft, together with the weight of all persons and goods (including fuel) on board the aircraft at the time.

ground controlled approach (GCA): A radar approach system operated from the ground by ATC personnel transmitting instructions to the pilot by radio.

ground effect area: A specified area (in relation to a HLS) which provides ground effect for a helicopter rotor system.

ground equipment: Articles of a specified nature for use in the maintenance, repair and servicing of an aircraft on the ground, including testing equipment and cargo and passenger handling equipment.*

ground taxiing: Movement of a helicopter under its own power and on its own undercarriage wheels.

ground-to-air communication: One way communication from stations or locations on the surface of the earth to aircraft.*

ground visibility: The visibility at an airport, as reported by an accredited observer.

H

hazard beacon: An aeronautical beacon used to designate a danger to air navigation.*

hazardous materials: Articles or substances which are capable of posing significant risk to health, safety or property.

heading: The direction in which the longitudinal axis of an aircraft is pointed, usually expressed in degrees from the North.

height: The vertical distance of a level, a point or an object considered as a point, measured from a specified datum.* The vertical dimension of an object.

Note: The word height may also be used in a figurative sense for other than vertical dimension, e.g. the height of a number or figure painted on a runway.

helicopter: A heavier-than-air aircraft supported in flight by the reaction of air on one or more normally power driven rotors on substantially vertical axes.*

helicopter clearway: A defined area on the ground or water under the control of the ...(HLS owner)... selected and/or prepared as a suitable area over which a performance Class 1 helicopter may accelerate and achieve a specific height.*

helicopter deck (or helideck): A helicopter landing site located on an off-shore structure or vessel.

helicopter ground taxiway: A ground taxiway for use by helicopters only. See also "ground taxiing".



helicopter landing site (HLS): An aerodrome for use by helicopters. Guidelines for the establishment of a HLS are provided by CASA in CAAP No.92-2(0).

helicopter movement area: That part of the movement area of an airport that can safely be used for the hovering, taxiing, take-off and landing of helicopters, and consists of maneuvering area and aprons, but excludes those areas reserved for unrestricted use by the general public.

helicopter overall length: In the case of single main rotor helicopters the distance between the main rotor tip at its furthest point forward and the tail rotor tip at its furthest point aft (or the aftermost point of the fuselage if this extends beyond the arc of the tail rotor). In the case of helicopters with two main rotors in tandem, the distance between rotor tips fore and aft of the helicopter.

helicopter stand: An aircraft stand which provides for parking a helicopter and, where air taxiing operations are contemplated, the helicopter touchdown and lift off.*

helideck: See "helicopter deck".

heliport: An aerodrome or a defined area on a structure intended to be used wholly or in part for the arrival, departure and surface movement of helicopters.*

holding bay: A defined area in the taxiway system where an aircraft can be held or by-passed to facilitate efficient surface movement of aircraft.*

holding point: See "taxi holding position".

hover: Flight at zero ground speed.

!

identification beacon: An aeronautical beacon emitting a coded signal by means of which a particular point of reference can be identified.*

IFR operation: An operation conducted in accordance with the Instrument Flight Rules prescribed in Part XII of the Civil Aviation Regulations. These operations (landings and take-offs at an airport) are made in periods of inclement weather and poor visibility and under these conditions, positive control on approach and climb-out is maintained by the use of electronic navigational aids. See also "Instrument Flight Rules".

illuminated wind indicator (IWI): A lighted wind direction indicator provided at an airport which has night landing facilities.

incident: An occurrence, other than an accident, associated with the operation of an aircraft that affects or could affect the safety of the operation of the aircraft.# In practice this definition is broadly interpreted and the incident reporting system accepts any reports, requests, complaints and suggestions which relate to aviation safety.

independent parallel approaches: Simultaneous approaches to parallel or near-parallel instrument runways where radar separation minima between aircraft on adjacent extended runway centrelines are not prescribed.*

independent parallel departures: Simultaneous departures from parallel or near-parallel instrument runways.

inertial navigation system (INS): A self-contained navigation system which continually measures the acceleration forces acting on the vehicle of which it is a part. Suitably integrated, these forces provide velocity and then position information. INS is **especially useful** for very long-range flights and long transoceanic sectors.

instrument approach runway: See "instrument runway".

instrument departure: See "standard instrument departure" and "standard radar departure".

initial approach segment: That segment of an instrument approach procedure between the initial approach fix and the intermediate approach fix or, where applicable, the final approach fix.*

inner approach surface: See "obstacle limitation surfaces (OLS)".

inner horizontal surface: See "obstacle limitation surfaces (OLS)".

inner transitional surface: See "obstacle limitation surfaces (OLS)".

instrument approach procedure: A series of pre-determined manoeuvres by reference to flight instruments with specified protection from obstacles from the initial approach fix, or where applicable, from the beginning of a defined arrival route, to a point from which a landing can be completed and thereafter, if a landing is not completed, to a position at which holding or en-route clearance criteria apply.* The approved



procedure to be followed by aircraft in letting down from cruising level and landing at an aerodrome.#

Instrument Flight Rules (IFR): A set of rules, as outlined in Part XI of the CAR, governing the conduct of flight under instrument meteorological conditions (IMC). See also "IFR operation".

instrument landing system (ILS): A system consisting of radio navigation aids using radio wave transmission adequate for guiding an aircraft to a specified position in IMC, from which landing and subsequent taxiing is possible using visual ground aids. (This definition is not applicable to a precision approach Category III which enables aircraft to land without using visual ground aids and then taxi visually).

Instrument meteorological conditions (IMC): Meteorological conditions expressed in terms of visibility, distance from cloud and ceiling less than minima specified for visual meteorological conditions (VMC).*

instrument runway: One of the following types of runways intended for the operation of aeroplanes using instrument approach procedures:

- **non-precision approach runway** - an instrument runway served by visual aids and a non-visual aid providing at least directional guidance adequate for a straight in approach;
- **precision approach runway, Category I** - an instrument runway served by an ILS and visual aids intended for operations down to 60 m (200 feet) decision height and down to an RVR of the order of 800 metres;
- **precision approach runway Category II** - an instrument runway served by an ILS and visual aids intended for operations down to 30 m (100 feet) decision height and down to an RVR to the order of 400 metres;
- **precision approach runway Category III** - an instrument runway served by an ILS to and along the surface of the runway and intended for operations;
- **down to an RVR to the order of 200 m** (no decision height being applicable) and using visual aids during the final phase of the landing;
- **down to an RVR to the order of 50 m** (no decision height being applicable) and using visual aids for taxiing; and

- without reliance on visual reference for landing or taxiing.*

intermediate approach segment: That segment of an instrument approach procedure between either the intermediate approach fix and the final approach fix, or between the end of the reversal, racetrack or dead reckoning track procedure and the final approach fix or point, as appropriate.*

international airline: An air transport enterprise offering or operating an international air service.#

international airport: An airport of entry and departure for international air traffic, where formalities incidental to customs, immigration, public health, animal and plant quarantine and similar procedures are carried out.*

international air service: An air service which passes through the airspace over the territory of more than one country.#

International Air Transport Association (IATA): The association incorporated under that name by Act 9-10 George VI., Chapter 51, of the Parliament of Canada. # IATA is an organisation with more than 100 scheduled international air carrier members. Its role is to foster the interests of civil aviation, to provide a forum for industry views, and to establish industry practices.

International Civil Aviation Organisation (ICAO): The organisation so named, formed under Article 43 of the Chicago Convention.# ICAO has a sovereign body, the Assembly, and a governing body, the Council. One of the principal functions and duties of the Council is to adopt international standards and recommended practices, which are incorporated as Annexes to the Convention on International Civil Aviation.

international NOTAM office (NOF): An office designated for the exchange of NOTAM internationally.

International Standard Atmosphere (ISA): See "standard atmosphere".

isogonal: A line on a map or chart on which all points have the same magnetic variation for a specified epoch (date).*

J



jet propelled aircraft: Includes an aircraft that is propelled by one or more turbofan engines, turbojet engines, unducted engines or rocket engines, but does not include an aircraft that is propelled solely by conventional propeller engines.#

Note: This definition does not specify if "conventional propeller engines" include prop-jets (i.e. propeller driven aircraft powered by jet engines as distinct from reciprocating engines).

joint oil storage facility (JOSF): An aircraft fuel storage facility jointly owned and operated by a consortium of fuel companies.

joint user airport: An airport under the control of a part of the Defence Force in respect of which an arrangement under Section 20 of the *Civil Aviation Act 1988* is force. Although aerodromes other than these may be used jointly on occasions, they are not regarded as joint user airports.

joint user hydrant installation (JUHI): An aircraft refuelling facility consisting of fuel storage tanks, underground reticulation and in-ground hydrants, jointly owned and operated by a consortium of fuel companies.

L

land and hold short operations (LAHSO): a procedure which permits the simultaneous landing and take-off of aircraft on intersecting runways.

landing area: That part of the maneuvering area primarily intended for landing or take-off of aircraft.* (The term "runway" is more commonly accepted).

landing and lift-off area: In relation to a HLS, means the area within the HLS on which a helicopter lands and takes off.

landing chart: See "aerodrome chart".

landing distance available (LDA): See "declared distances".

landside: The portion of an aerodrome not designated as airside and to which the general public normally has free access.

level: A generic term relating to the vertical position of an aircraft in flight and meaning variously, height, altitude or flight level.*

light aircraft: An aircraft with MAUW which does not exceed 5 700 kg.

local standby: A situation in which activation of only the airport-based agencies involved in the AEP is warranted. A local standby is the usual response when an aircraft approaching an airport is known or is suspected to have developed some defect, but the trouble is not such as would normally involve any serious difficulty in effecting a safe landing.

localiser: The component of an ILS which radiates left-right guidance signals relative to the extended runway centreline.

locator-inner: A low powered NDB providing supplementary guidance information during an ILS approach. It is usually located at the middle marker site on the ILS approach path.

locator-outer: A low powered NDB located 6 to 10 nautical miles from the runway threshold on the ILS approach track. This beacon provides the directional information necessary to guide the aircraft to the correct position to begin its ILS approach. Once established on the ILS localiser, the outer locator in conjunction with the inner locator provides supplementary track guidance.

lowest safe altitude (LSALT): The lowest altitude that will provide safe terrain clearance at a given place.

M

magnetic variation: The angular difference between True North and Magnetic North at a particular point on the earth's surface.*

main runway: The runway determined as such by AA..

mandatory broadcast zone (MBZ): An airspace of defined dimensions within which pilots must make specified broadcasts. Where established, details concerning a MBZ will be shown in ERSA.

maneuvering area: The part of an aerodrome to be used for the take-off, landing and taxiing of aircraft, excluding aprons.*

Manual of Air Traffic Services (MATS): An AA publication for issue to ATS staff.



Manual of Standards (MOS): Prepared by CASA to establish aviation standards. They are to be read in conjunction with the CASRs.

marker: An object displayed above ground level in order to indicate an obstacle or delineate a boundary.* A marker may also be used to give directions to pilots, e.g. unserviceable areas, displaced thresholds.

marking: A symbol or group of symbols displayed on the surface of the movement area in order to convey aeronautical information.* Markings are generally painted on the surface of the movement area, e.g. permanent threshold, runway centreline, aircraft weight restrictions, etc.

maximum landing weight: The weight set out in the certificate of airworthiness of, or the flight manual for, the aircraft as the maximum weight permitted for landing.

maximum take-off weight (MTOW): The weight set out in the certificate of airworthiness of, or the flight manual for, the aircraft as the maximum weight permitted for take-off.

maximum weight: The maximum weight for which the aircraft has been designed or certified to withstand taxiing stresses. Also known as maximum ramp weight or maximum taxi weight.

meteorological information: All classes of meteorological reports, analyses, forecasts, warnings, advice and revisions or amendments thereto which may be required in connection with the operation of air routes.

meteorological minima: The minimum values of meteorological elements as determined by the (Civil Aviation Safety) Authority in respect of specified types of flight operation.#

meteorological office: An office of a meteorological authority staffed and equipped to provide meteorological services to air navigation.

method of working plan (MOWP): A document which provides formal advice to the aviation industry and other involved parties, of the planned arrangements for the conduct of scheduled aerodrome works including restrictions to aircraft operations and to the works organisation, which are necessary for the continued safe operation of the airport during those works.

microwave landing system (MLS): A precision approach and landing system using a time based reference system.

middle marker (MM): A radio beacon situated on an ILS approach path some 1 000 metres from the runway threshold.

mile: See "nautical mile (NM)".

military airport: An airport under the control of any part of the Defence Force.#

minimum altitude: For a particular instrument approach procedure, the altitude specified at which an aircraft shall discontinue an instrument approach unless continual visual reference to the ground or water has been established and ground visibility is equal to or greater than that specified for landing.

minimum descent altitude/height (MDA/H): A specified altitude/height in a non-precision approach below which descent may not be made without visual reference.

minimum sector altitude (MSA): The lowest altitude which will provide a minimum clearance of 1,000 feet above all objects located in an area contained within a sector of a circle of 25 NM radius centred on a radio aid to navigation.

minimum vector altitude (MVA): The lowest altitude a radar controller may assign to a pilot in accordance with a radar terrain clearance chart.

missed approach point (MAPt): That point in an instrument approach procedure at or before which the prescribed missed approach procedure must be initiated in order to ensure that the minimum obstacle clearance is not infringed.*

missed approach procedure: The procedure to be followed if the approach cannot be continued.*

mobile command post: See "forward command post (FCP)".

mobile fuel dispenser: A vehicle, self propelled or towed, fitted with fuel dispensing equipment such as meters, filters, valves, hoses and pumps used to deliver fuel from hydrant points or bulk fuel tanks to aircraft or vehicles, in accordance with CAO 20.9.

movement: Either a take-off or a landing by an aircraft.

movement area: That part of an aerodrome to be used for the take-off, landing and taxiing (i.e. surface movement) of aircraft, including maneuvering areas and apron(s).*



movement area guidance signs (MAGS): Signs located adjacent to runways and taxiways which convey instructions or information to pilots.

movement area lighting: Runway, taxiway and apron lighting provided at an airport intended to be used at night to assist a pilot in locating the airport, and in landing, take-off, taxiing and parking.

N

nautical mile (NM): A length of 1 852 metres.

navaid: See "air navigation aid"

near-parallel runways: Non-intersecting runways whose extended centrelines have an angle of convergence/ divergence of 15 degrees or less.

night: The hours between sunset and sunrise.

non-controlled airport: An airport not having an air traffic control service.

non-instrument runway: A runway intended for the operation of aircraft using visual approach procedures.*

non-precision approach runway: See "instrument runway".

Notice To Airmen (NOTAM): A notice containing information concerning the establishment, condition or change in any aeronautical facility, service, procedure or hazard, the timely knowledge of which is essential to persons concerned with flight operations.* **NOTAM** are published under Section 8 of the *Air Services Act 1995*.

O

obstacles: All fixed (whether temporary or permanent) and mobile objects, or parts thereof, that are located on an area intended for the surface movement of aircraft, or which extend above a defined surface intended to protect aircraft in flight.* See also "obstacle limitation surfaces (OLS)".

obstacle assessment surface (OAS): A defined surface intended for the purpose of determining those obstacles to be considered in the calculation of obstacle clearance height for a specific ILS facility and procedure.

obstacle control: Measures taken to monitor the OLS and critical PANS-OPS surfaces in order to detect the presence of new obstacles, whether temporary or permanent, and as far as practicable, to prevent the erection new structures that would affect aircraft or airport operations.

obstacle free zone (OFZ): The airspace above the inner approach surface, inner transitional surfaces and baulked landing surface and that portion of the runway strip bounded by these surfaces, which is not penetrated by any fixed obstacle other than a light weight and frangibly mounted one required for air navigation purposes.*

obstacle lights: Lights mounted on or adjacent to obstacles or potential hazards to aircraft moving on the ground or in the navigable airspace, for the purpose of indicating the obstructions or hazards by night.

obstacle limitation surfaces (OLS): A series of planes associated with each runway of an airport, or the airport itself, which define the desirable limits to which objects may project into the airspace around the airport. Objects penetrating an OLS are defined as obstacles and may need to be marked and/or lit in accordance with CASA requirements. Individual surfaces comprising the OLS are:

- **outer horizontal surface** - a plane located 150 m above the aerodrome reference elevation datum and extending from the upper edge of the conical surface over a radius of 15 000 m from the ARP;
- **conical surface** - a surface sloping upward and outward from the periphery of the inner horizontal surface to a specified height above that surface;
- **inner horizontal surface** - a plane at a specified height above the aerodrome reference elevation datum extending to a specified outer boundary;
- **approach surface** - an inclined plane or combination of planes originating at the inner edge associated with each runway threshold;
- **inner approach surface** - a rectangular portion of the approach surface immediately preceding the threshold;
- **transitional surface** - inclined planes which originate from the edges of the runway strip and the sides of the approach surface and



extend upward and outward at a specified rate to the inner horizontal surface:

- **inner transitional surface** - surfaces like the transitional surfaces but closer to the runway and of different slope;
- **baulked landing surface** - an inclined plane originating at a specified distance after the threshold and extending between the inner transitional surfaces; and
- **take-off climb surface** - a plane originating at the end of the clearway, sloping upward and diverging at a specified rate.

obstruction: An obstacle which prevents aircraft operations to or from a runway.

OMEGA: A world-wide hyperbolic navigation system utilising signals in the VHF band transmitted from suitably sited ground stations. The signal is processed at the receiver to display present position and is therefore suitable for area navigation.

operating empty weight: The weight of an aircraft in its normal operating configuration but excluding passengers, payload and usable fuel.

operator: In relation to aircraft, a person, organisation or enterprise engaged in, or offering to engage in, an aircraft operation.* In relation to an airport, see "airport operator".

outer horizontal surface: See "obstacle limitation surfaces (OLS)".

outer main gear wheel span: The distance between the outer edges of an aircraft's main gear wheels.

P

PANS-OPS (procedures for air navigation services - aircraft operations) criteria: The ICAO specification for obstacle assessment or identification and allowances for minimum obstacle clearance used in the design of each stage of an instrument departure or approach procedure.

passenger: Any person who is on board an aircraft other than a member of the operating crew.#

pavement: A prepared surface of a given depth providing added bearing capacity to an existing ground surface.

pavement classification number (PCN): A number expressing the bearing strength of a pavement for unrestricted operations.*

permissible all-up-weight: The all-up-weight to which an aircraft is limited by virtue of the physical characteristics of the airport.

pilot: A person licensed by CASA to manipulate the flight controls of an aircraft during flight.

pilot-in-command: in relation to an aircraft, the pilot responsible for the operation and safety of the aircraft during flight of the aircraft.#

pilot activated lighting (PAL): Airport lighting that may be remotely switched on by transmission of a radio signal of designated frequency.

point of no return (PNR): The point farthest removed from base to which an aircraft can fly and return with the required reserves of fuel remaining.

portable fuel dispenser: A mobile arrangement fitted out in accordance with CAO 20.9, with fuel-dispensing equipment such as meters, filters, valves, hoses and pumps used to deliver fuel to aircraft or vehicles from drums or other containers.

precision approach path indicator system (PAPI): An ICAO approved approach slope indicator system designed to show red and white lights on correct approach slope, red only when too low and white only when too high.

precision approach procedure: An instrument approach procedure utilising azimuth and glide path information provided by ILS or PAR.*

precision approach radar (PAR): Primary radar equipment used to determine the position of an aircraft during final approach in terms of lateral and vertical deviations relative to a nominal approach path, and in range relative to touchdown.*

precision approach runway: See "instrument runway".

precision or electronic approach aid: Any air or ground interpreted navigation facility which accurately fixes the position of an aircraft in azimuth, elevation, and in some cases range with respect to the ground point of intercept.



preferred runway: A runway nominated by ATC as the most suitable for the prevailing wind, surface conditions and noise sensitive areas in the proximity of the airport.

prescribed airspace: Is the airspace above any part of either an OLS or a PANS-OPS surface for the airport.

pressure altitude: An atmospheric pressure expressed in terms of altitude which corresponds to that pressure in the standard atmosphere.*

primary radar: A radar system which uses reflected radio signals.

primary runway(s): Runway(s) used in preference to other(s) whenever conditions permit.*

procedure turn: A manoeuvre in which a turn is made away from a designated track followed by a turn in the opposite direction, to permit the aircraft to intercept and proceed along the reciprocal of the designated track.*

prohibited area: An airspace of defined dimensions, above the land areas or territorial waters of a State, within which the flight of aircraft is prohibited.*

prohibited area: Any part of an airport upon or in relation to which is posted a notice to the effect that access is prohibited.

protective service officer: A protective service officer, and a special protective service officer, within the meaning of the *Australian Protective Service Act 1987*.

public area: An area on an airport provided for public use, such as parts of the terminal building, car parks, roads or a viewing area.

public transport service: A service for the carriage of persons or cargo for hire or reward.

Q

QFE altimeter setting: That pressure setting which, when placed on the pressure setting sub-scale of a sensitive altimeter, will cause the altimeter to indicate height above the QFE reference datum.

QNH altimeter setting: That pressure setting which, when placed on the pressure setting sub-scale of a sensitive altimeter of an aircraft located at the reference point of an airport, will cause the altimeter to indicate height above mean sea level (AMSL).

R

racetrack procedure: A procedure designed to enable an aircraft to reduce altitude during the initial approach segment and/or establish the aircraft inbound when the entry into a reversal procedure is not practical.

radar: A radio detection device which provides information on range, azimuth and/or elevation of objects.*

radar advisory service (RAS): An ATC traffic information, avoidance and position information service, based primarily on radar derived data, to assist pilots in traffic avoidance and/or navigation.

radar approach: An approach to a runway, executed by an aircraft under the direction of a radar controller.*

radar control: A term used to indicate that radar-derived information is employed directly in the provision of air traffic control service.*

radar vectoring: Provision of navigational guidance to aircraft in the form of specific headings, based on the use of radar.*

radial: The track flown by an aircraft in directly approaching or departing from an air navigation aid.

radio compass: See "automatic direction finding (ADF)".

radiotelephonic language: The words and phrases that the (Civil Aviation Safety) Authority has directed under CAR 82A must be used in communication by radiotelephone; and the voice techniques commonly applied to radiotelephonic communications.

radio navigation aid: See "air navigation aid."

rapid exit taxiway (RET): See "taxiway".

recommended practice: Any specification for physical characteristics, configuration, material performance, personnel or procedure, the uniform application of which is recognised as desirable in the interests of safety, regularity or efficiency of international air navigation, and to which Contracting States will endeavour to conform in accordance with the Convention.*

recovery: The process of returning the airport to its normal operational status following an emergency or disabled aircraft incident.



registered aerodrome: An aerodrome registered under CASR Part 139.

regular public transport (RPT): The transport of persons generally, or cargo for persons generally, for hire or reward in accordance with fixed schedules and to and from fixed terminals over specific routes.

relief: The inequalities in elevation of the surface of the earth represented on the aeronautical charts by contours, hypsometric tints, shading or spot elevations.

reporting: See "airport reporting".

reporting officer: A person so designated by CASA and nominated by the airport operator to report and advise on any defects or hazards on the movement area or within the OLS that may affect the safety of aircraft/airport operations.

reporting point: A specific geographical location to which the position of an aircraft can be reported.*

rescue coordination centre: A centre that coordinates search and rescue within an assigned area.

response: The process of combating an emergency and of providing relief for persons affected by the emergency.

restricted area: An airspace of defined dimensions, above the land areas or territorial waters of a State, within which the flight of aircraft is restricted in accordance with certain specified conditions.

restricted area: Any part of an airport upon or in relation to which is posted a notice to the effect that access is restricted to persons holding an authorised identification card valid for that part of the airport.

reversal procedure: A procedure designed to enable aircraft to reverse direction during the initial approach segment of an instrument approach procedure. The sequence may include procedure turns or base turns.

rotating beacon: See "aerodrome beacon".

route: A way to be taken in flying from a departure to a destination airport, specified in terms of track and distance from each route segment.

route surveillance radar (RSR): A long range radar which is used for enroute surveillance by ATC personnel.

RPT aircraft: An aircraft employed in regular public transport operations.#

RPT service: A service consisting of regular public transport operations.#

Rules and Practices for Aerodromes (RPA): A former CASA document which provided a statement of the Authority's standards and recommended practices for airports.

runway (RWY): A defined rectangular area on a land aerodrome, prepared for the landing and take-off of aeroplanes long its length.*

runway designation markings (runway number): A two digit number allocated to a runway end, derived from one tenth of the magnetic bearing of the runway centreline (when viewed from the approach) rounded to the nearest 10 degrees. Single digit numbers so obtained are preceded by "0" and where the final numeral of the bearing is 5 degrees, the number allocated is the next largest number.

runway end safety area (RESA): An area symmetrical about the extended runway centreline and adjacent to the end of runway strip, intended primarily to reduce the risk of damage to an aeroplane undershooting or over-running the runway.*

runway strip (RWS): A defined area including the runway and stopway, if provided, intended:

- to reduce the risk of damage to aircraft running off a runway; and
- to protect aircraft flying over it during take-off or landing operations.*

runway visibility: The distance over which an authorised person on the centreline of the runway can see the runway surface markings or the lights delineating the runway or identifying its centreline.

runway visual range (RVR): The range over which the pilot of an aircraft on the centreline of a runway can see the runway surface markings or the lights delineating the runway or identifying its centreline.* A value derived by instruments, based on standard calibrations that represents the horizontal distance a pilot will see down the runway.

S

safety area: A defined area on a heliport surrounding the FATO which is free of obstacles, other than those required for air navigation purposes, and intended to



reduce the risk of damage to helicopters accidentally diverging from the FATO.*

safety officer: Airport Operations Officer (see also "works safety officer").

SAR alerting service: A service provided to notify appropriate organisations regarding aircraft in need of search and rescue (SAR) aid, and to assist such organisations as required.

SARTIME: The time nominated by a pilot for the initiation of search and rescue (SAR) action if a report has not been received by the nominated time.

search and rescue (SAR): The act of finding and where possible, returning to safety, aircraft and persons involved in an emergency phase.

secondary surveillance radar (SSR): A system of secondary radar using ground transmitters/receivers (interrogators) and airborne transponders.

security: See "aviation security".

security control: A means by which the introduction of weapons or articles likely to be utilised to commit an act of unlawful interference can be prevented.*

security equipment: Devices of a specialised nature for use (individually or as part of a system) in the prevention or detection of acts of unlawful interference with civil aviation and its facilities.*

security programme: Measures adopted to safeguard civil aviation against acts of unlawful interference.

segregated parallel operations: Simultaneous operations on parallel or near-parallel instrument runways in which one runway is used exclusively for approaches and the other runway is used exclusively for departures.*

shoulder: An area adjacent to the edge of a runway, taxiway or apron pavement so prepared as to provide a transition between the pavement and the adjacent surface.*

signal area: A selected part of an aerodrome used for the display of ground signals so that they will be visible to aircraft in the air.#

simultaneous runway operations (SIMOPS): An ATC procedure which permits the simultaneous landing of aircraft or the simultaneous landing and take-off of aircraft on intersecting runways.

site control: See "forward command post (FCP)."

staging area: A prearranged, strategically located area on or off airport where support response personnel, vehicles and other equipment can be **assembled**.

standard: Any specification for physical characteristics, configuration, material, performance, personnel or procedure, the uniform application of which is recognised as necessary for the safety or regularity of international air navigation and to which Contracting States will conform in accordance with the Convention. In the event of impossibility of compliance, notification to the Council is compulsory under Article 38 of the Convention.*

standard atmosphere, or international standard atmosphere (ISA): In general terms, an atmosphere which represents a sea level atmospheric pressure of 1013.2 hectopascals or millibars at a temperature of 15 degrees Celsius.

standard instrument departure (SID): A published IFR departure comprising obstacle clearance data to the minimum sector altitude, and tracking data until the aircraft reaches a specified point on its ATC cleared route.

standard pressure: The pressure of 1013.2 hPa or mb which, when set on the pressure sub-scale of a sensitive altimeter, will cause the altimeter to indicate zero when at mean sea level in a standard atmosphere.

standard radar departure (SRD): A published ground radar based IFR departure comprising standard climb gradient data to minimum sector altitude while being radar vectored by ATC.

start of take-off (SOT): The point on a runway from which the take-off commences (previously known as the brake release point). The SOT is normally the beginning of the runway and is the point from which the TORA, TODA and the ASDA commence and from which distances to obstacles are measured when such advice is issued to pilots.

sterile area: In relation to an airport, an area in the airport to which persons, vehicles and goods are not permitted access until screened and given clearance, in relation to aviation security, under Part 4 of the *Aviation Transport Security Regulations 2005* .#

stopway: A defined rectangular area on the ground at the end of the runway at the end of the take-off run available, prepared and maintained as a suitable area in which an aircraft can be safely stopped in the case of an abandoned take-off.*

supplementary take-off distance available (STODA): Take-off distance available relative to specified



obstacle-free take-off climb surface gradients. STODA are published in the AIP-ERSA for gradients of 1.6%, 1.9%, 2.2%, 2.5%, 3.33% and 5% if the end of TODA gradient exceeds these figures and the resultant STODA is greater than 800 metres.

surveillance radar: Radar equipment used to determine the position of an aircraft in range and azimuth.

I

tactical air navigation (TACAN): An ultra-high frequency navigation aid which provides a continuous indication of bearing and distance, in nautical miles, to the selected TACAN ground station.

take-off: Accelerate to, and commence climb at, the relevant climb speed.

take-off climb area: The vertical projection to the ground of the take-off climb surface.

take-off climb surface: See "obstacle limitation surfaces (OLS)".

take-off distance available (TODA): See "declared distances".

take-off run available (TORA): See "declared distances".

taxiing: The surface movement of an aircraft under its own power, excluding take-off and landing but including, in the case of helicopters, operation over the surface of an airport within a height band associated with ground effect and at speeds associated with taxiing, i.e. air taxiing.*

taxi holding position: A designated position at which taxiing aircraft and vehicles may be required to hold in order to provide adequate clearance from a runway.*

taxiway: A defined path on a land aerodrome established for the taxiing of aircraft and intended to provide a link between one part of the airport and another, including;

- **aircraft stand taxiway** - a portion of an apron designated as a taxiway and intended to provide access to aircraft stands only;

- **apron taxiway** - a portion of a taxiway system located on an apron and intended to provide through taxi routes across the apron; and

- **rapid exit taxiway (RET)** - a taxiway connected to a runway at an acute angle designed to allow landing aeroplanes to turn off the runway at higher speeds than on other exit taxiways, thereby minimising runway occupancy times.*

taxiway intersection: A junction of two or more taxiways.*

taxiway strip: An area including a taxiway and intended to protect an aeroplane operating on the taxiway and to reduce the risk of damage to an aeroplane accidentally running off the taxiway.*

terminal approach radar (TAR): A high definition radar used for air traffic control purposes in the terminal area.

terrain clearance: The vertical distance of an aircraft flight path from the terrain.

threshold (THR): The beginning of that portion of the runway useable for landing.* The threshold is the point on the runway from which the LDA is measured.

threshold crossing height: The height of the ILS glide path at the threshold.

time limited works: Airport works that may be carried out without restriction if normal aircraft operations are not disrupted, and the movement area can be restored to normal safety standards in from 10 to 30 minutes.

touchdown and lift-off area (TLOF): A load bearing area on which a helicopter may touch down or lift off.*

touchdown zone (TDZ): The portion of a runway, beyond the threshold, where it is intended landing aeroplanes first contact the runway.*

track: The projection on the earth's surface of the path of an aircraft, the direction of which at any point is usually expressed in degrees bearing from north (True, Magnetic or Grid).*

traffic advisory service: A service provided by ATC for the purpose of giving traffic information and advice, except avoidance advice, to help a pilot avoid a collision.*

traffic avoidance advice: Advice provided by ATC specifying manoeuvres to help a pilot avoid a collision.



traffic information: Information issued by ATC or Flight Service to alert the pilot of an aircraft to other aircraft that may be close to the position, or to the intended route, of his or her aircraft, so as to help the pilot avoid a collision.#

traffic pattern: The path over the ground of aircraft in flight in the vicinity of an airport during the execution of take-offs and landings and their paths when maneuvering on the maneuvering area.#

triage: Sorting and classification of casualties to determine the order of priority for their treatment and transportation.

transitional surface: See "obstacle limitation surfaces (OLS)".

transponder: A receiver/transmitter which will generate a reply signal upon proper interrogation; the interrogation and reply being on different frequencies.

T-visual approach slope indicator system (TVA): An Australian developed visual landing aid which changes pattern to indicate the correct approach slope. Also known as T-VASIS, but ICAO has requested this term not be used as VASIS (Visual Approach Slope Indicator System) is reserved for the international standard system.

U

unserviceable area: A portion of the movement area not available for use by aircraft because of the physical condition of the area or because of obstacles affecting it.

usability factor: The percentage of time during which the use of a runway or system of runways is not restricted because of the cross-wind component.*

V

VHF omni-directional radio range (VOR): A VHF radio navigation aid which provides a continuous indication of bearing from the selected VOR ground station. It provides 360 degree radial tracks to the beacon corresponding to the points of the magnetic compass and which may be selected at one degree intervals by the pilot.

visibility: The ability, as determined by atmospheric conditions and expressed in units of distance, to see and identify prominent unlit objects by day and prominent lighted objects by night.* Visibility is divided into two classes as follows:

- **flight visibility** - the average range of visibility forward from the cockpit of an aircraft in flight; and
- **ground visibility** - the visibility at an airport, as reported by an approved observer.

visual: Used by ATC to instruct a pilot to see and avoid obstacles while conducting flight below the MVA or MSA/LASLT. Used by a pilot to indicate acceptance of responsibility to see and avoid obstacles while operating below the MVA or MSA/LSALT.

visual approach: An approach by an aircraft to a runway executed by a visual reference to terrain.*

visual approach slope indicator system (VASIS): A system of lights arranged to provide visual information to pilots of approaching aircraft of their position in relation to the optimum approach slope for a particular runway. The ICAO standard system developed in the UK consisting of two bars of lights straddling the runway and designed to show red over white lights on the correct approach slope, red over red when too low and white over white when too high.

visual flight rules (VFR): Rules of flight to permit operations on a see and be seen basis in visual meteorological conditions (VMC). These rules are prescribed in Part XII of the CAR.

visual maneuvering (circling) area: The area in which obstacle clearance should be taken into consideration for aircraft carrying out a circling approach.

visual meteorological conditions (VMC): Meteorological conditions in which the flight visibility and distances from cloud during a flight are equal to, or greater than the applicable distances determined by the (Civil Aviation Safety) Authority under CAR 172(2).

W

warning agency: The agency that has initial information on an emergency or potential emergency and responsibility to advise other agencies.



wheel base: The distance from the nose gear (or tail wheel) of an aeroplane to the geometric centre of the main gear.

wind direction indicator (WDI): A wind sleeve (sock) to provide information to pilots on wind direction and strength. Where night landing facilities are provided, at least one WDI will be lit. See "illuminated wind indicator (IWI)".

works safety officer (WSO): The person appointed by the airport operator to ensure that the conduct of airport works, insofar as they affect the safe operations of aircraft, is in accordance with the relevant part of the CASR and, if applicable the MOWP, and otherwise to

maintain the safety of aircraft operations in relation such works

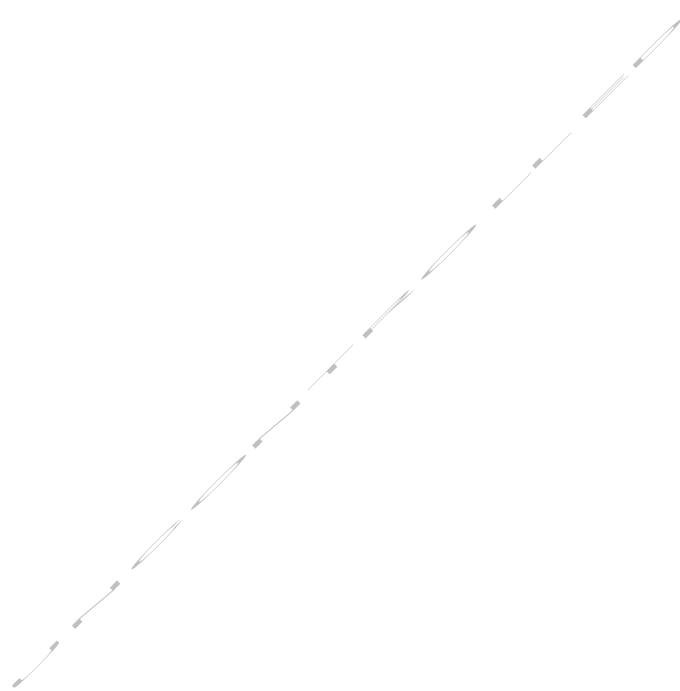

Abbreviations

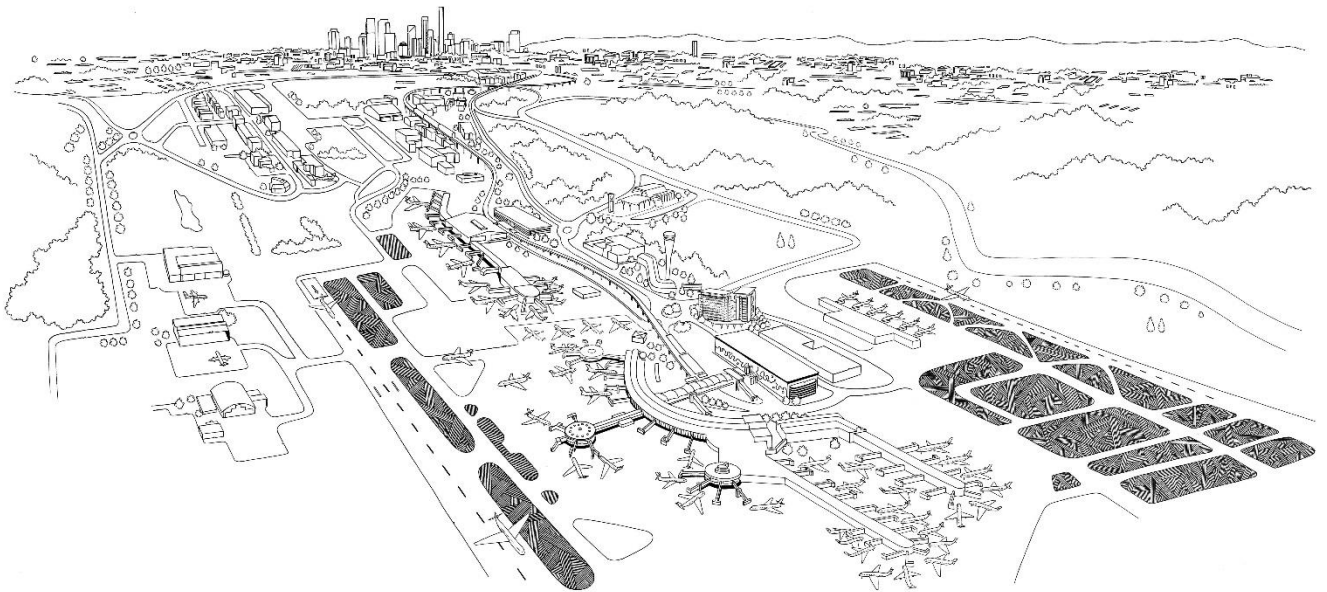



Abbreviations

The following list contains all key abbreviations used in this Manual, as well as others likely to be in common use. Users should note that the list makes no attempt to include all abbreviations used in composition of NOTAM, as a separate listing is readily available in *MOS Part 139, Chapter 10*.

AsA: Airservices Australia	AIRAC: aeronautical information regulation and control	APS: Australian Protective Services
AAA: Australian Airports Association	AIS: aeronautical information service/s	APU: auxiliary power unit
ABN: aerodrome beacon	ALA: aircraft landing area	ARFL: aeroplane reference field length
AC: Advisory Circular	ALER: airport lighting equipment room	ARP: aerodrome reference point
ACC: airport coordination centre (BAC)	AMSL: above mean sea level	ARFF: Aviation Rescue & Fire Fighting (formerly "RRFS")
ACC: area control centre (AA)	ANEC: Australian noise exposure concept	ARRFU: see "RRFU"
ACFT: aircraft	ANEF: Australian noise exposure forecast	AS: Australian standard
ACN: aircraft classification number	ANEI: Australian noise exposure index	ASDA: accelerate-stop distance available
ADA: Airside Driving Authority	ANO: air navigation order	ASI: airport safety inspector
ADDGM: aerodrome diagram	ANR: air navigation regulation	ASIC: aviation security identification card
ADF: automatic direction finding	AOC: aerodrome obstacle chart	ASIR: Air Safety Incident Report
AEC: airport emergency committee	AOC: airline operators committee	ASR: Air Services Regulations
AEP: airport emergency plan	AOC: air operator's certificate	ATIS: automatic terminal information service
AEPC: airport emergency planning committee	ARO: Aerodrome Reporting Officer, supervisor, coordinator	ATC: air traffic control
AFS: aeronautical fixed service	AOO: airside operations officer – see ARO	ATS: air traffic services
AFTN: aeronautical fixed telecommunication network	AOSP: airport operating standards and practices published by the former FAC	ATSB: Australian Transport Safety Bureau
AGA: aerodromes, air routes and ground aids	APFL: apron floodlighting	AT-VASIS: abbreviated T-VASIS
AGL: above ground level	APLPH: airport lighting power house	AUA: Authority for Use Airside
AHD: Australian height datum	APPL: approach lighting	AVGAS: aviation gasoline
AIC: aeronautical information circular	APPR: approach	AVTUR: aviation turbine fuel
AIP: aeronautical information publication		



BAC: Brisbane Airport Corporation Limited

BAFS: Brisbane Airport Fuel Service

BN: Brisbane

CASA: Civil Aviation Safety Authority

CAAP: civil aviation advisory publication

CAO: civil aviation order

CASR: civil aviation safety regulation

CofA: certificate of airworthiness

CMMS: Computerised Maintenance Management System

COM: communications

CSS: central supervisory system

CTA: control area

CTAF: common traffic advisory frequency

CTR: control zone

CWY: clearway

DAP: departure and approach procedures

DA/H: decision altitude/height

DEHP: Department of Environment and Heritage Protection

DISPLAN: disaster plan

DME: distance measuring equipment

DOD: Department of Defence

DoTARS: Department of Transport and Regional Services (now see DIRDC)

DIRDC: Department of Infrastructure Regional Development and Cities

DTB: Domestic Terminal Building

DTM: Duty Terminal Manager

DTRM: distance to run markers

EAP: emergency assembly point

EOC: emergency operations centre

ELB: emergency locator beacon

ERSA: enroute supplement - Australia

ESIWL: equivalent single isolated wheel load

EST: eastern standard time

EST: estimated

ETA: estimated time of arrival

EWIS: early warning indicator system

FAC: facilities

FAC: Federal Airports Corporation

FAF: final approach fix

FATO: final approach and take-off area

FCP: forward command post

FIA: flight information area

FIG: flight information centre

FIDS: flight information display system

FIR: flight information region

FIS: flight information service

FL: flight level

FSU: flight service unit

GA: general aviation

GP: glide path

HAZMAT: hazardous materials

HBN: hazard beacon

HD: hazard division

HF: high frequency (3,000 - 30,000 kHz)

HIAL: high intensity approach lighting

HIL: high intensity lighting

HJ: daylight hours (sunrise to sunset)

HLS: helicopter landing site

HN: night hours (sunset to sunrise)

H24: continuous (day and night)

IAL: instrument approach and landing chart

IAS: indicated air speed

ICAO: International Civil Aviation Organisation



IFR: instrument flight rules	MAUW: maximum all up weight	OPR: operator
ILS: instrument landing system	MBZ: mandatory broadcast zone	
IM: inner marker	MEDIPLAN: disaster medical plan	PAL: pilot activated lighting
IMC: instrument meteorological conditions	MLS: microwave landing system	PANS-OPS: procedures for air navigation services - aircraft operations
INS: inertial navigation system	MM: middle marker	PAR: precision approach radar
ISA: international standard atmosphere	MOWP: method of working plan	PAPI: precision approach path indicator
ITB: International Terminal Building	MOS: Manual of Standards	PCN: pavement classification number
IWI: illuminated wind indicator	MSA: minimum sector altitude	PTCW: permit to commence work
	MSL: mean sea level	PFIB: pre-flight information bulletin
JOSF: joint oil storage facility	MTOW: maximum take-off weight	PNR: point of no return
JUHI: joint user hydrant installation	MTP: maximum tyre pressure	POB: Persons on board
	MVA: minimum vector altitude	
	NDB: non-directional beacon	
LAHSO: land and hold short operations	NFPMS: noise and flight path monitoring system	QAS: Queensland Ambulance Service
LDA: landing distance available	NIGS: nose-in guidance system	QATS: Queensland Air Terminal Services
LJA: low jet route	NOF: (Australian) NOTAM office	QFE: Q code - altimeter setting to obtain height above the airport datum
LSALT: lowest safe altitude	NM: nautical mile	QNH: Q code - altimeter setting to obtain altitude (height AMSL)
	NMT: noise monitoring terminal	QPS: Queensland Police Service
MECP: master evacuation control panel	NOTAM: notice to airmen	
MDA/H: minimum descent altitude/height	OAS: obstacle assessment surface	RAAF: Royal Australian Air Force
MAG: magnetic	OFZ: obstacle free zone	RAS: radar advisory service
MAGS: movement area guidance signs	OIC: officer in charge	RESA: runway end safety area
MAPt: missed approach point	OLS: obstacle limitation surface	RET: rapid exit taxiway
MATS: manual of air traffic services	OM: outer marker	RFDS: Royal Flying Doctor Service
	OMC: Operation Monitoring and Control	



RFFS: rescue and fire fighting service

RGL: Runway Guard Lighting

RPT: regular public transport

RSR: route surveillance radar

RVR: runway visual range

RWS: runway strip

RWY: runway

SAR: search and rescue

SARO: search and rescue officer

SATC: senior air traffic controller

SID: standard instrument departure

SIMOPS: simultaneous runway operations

SIN: security incident notices

SMC: surface movement control

SMM: safety management manual

SMS: safety management system

SOT: start of take-off

SRD: standard radar departure

STODA: supplementary take-off distance available

STOL: short take-off and landing

SUP: AIP supplement

SWY: stopway

TACAN: tactical air navigation

TAR: terminal approach radar

TBPH: terminal building power house

TCI: Technical Customer Interface

TDZ: touchdown zone

THR: threshold

TKOF: take-off

TLOF: touchdown and lift-off area

TODA: take-off distance available

TORA: take-off run available

TSP: Transport Security Program

TVA: T-VASIS

T-VASIS: T - visual approach slope indicator system

TWR: airport control tower

TWY: taxiway

UHF: ultra high frequency (300 - 3000 MHz)

UTC: coordinated universal time

VAL: visual assessment lights

VASIS: visual approach slope indicator system

VFR: visual flight rules

VHF: very high frequency (30 - 300 MHz)

VMC: visual meteorological conditions

VOR: VHF omni-directional radio range

VTOL: vertical take-off and landing

WAC: World Aeronautical Chart (ICAO 1:1 000 000)

WDI: wind direction indicator

WID: width

WHMP: Wildlife Hazard Management Plan

WIP: works in progress

WSO: works safety officer

YBBN: Brisbane Airport